

1

2

3

4

5

6

7

8

A

B

C

D

E

F

G

H

A

B

C

D

E

F

G

H

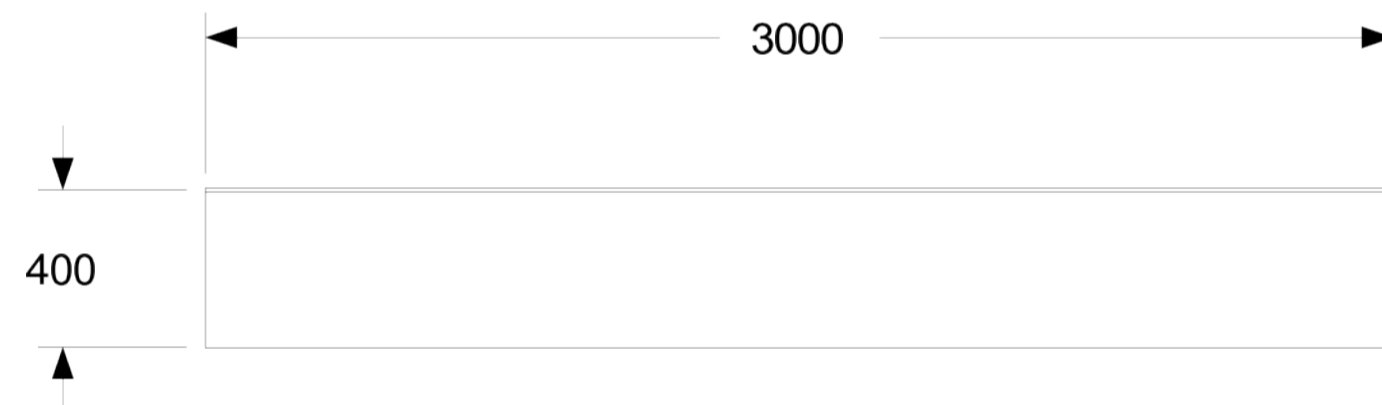
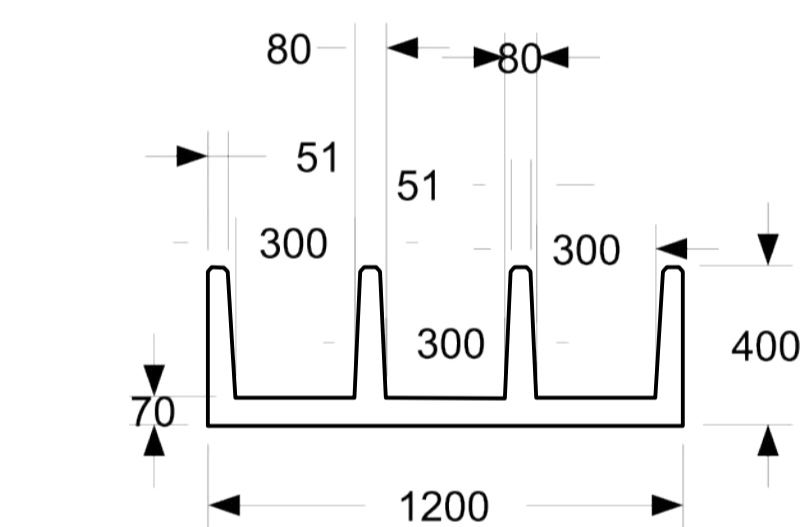
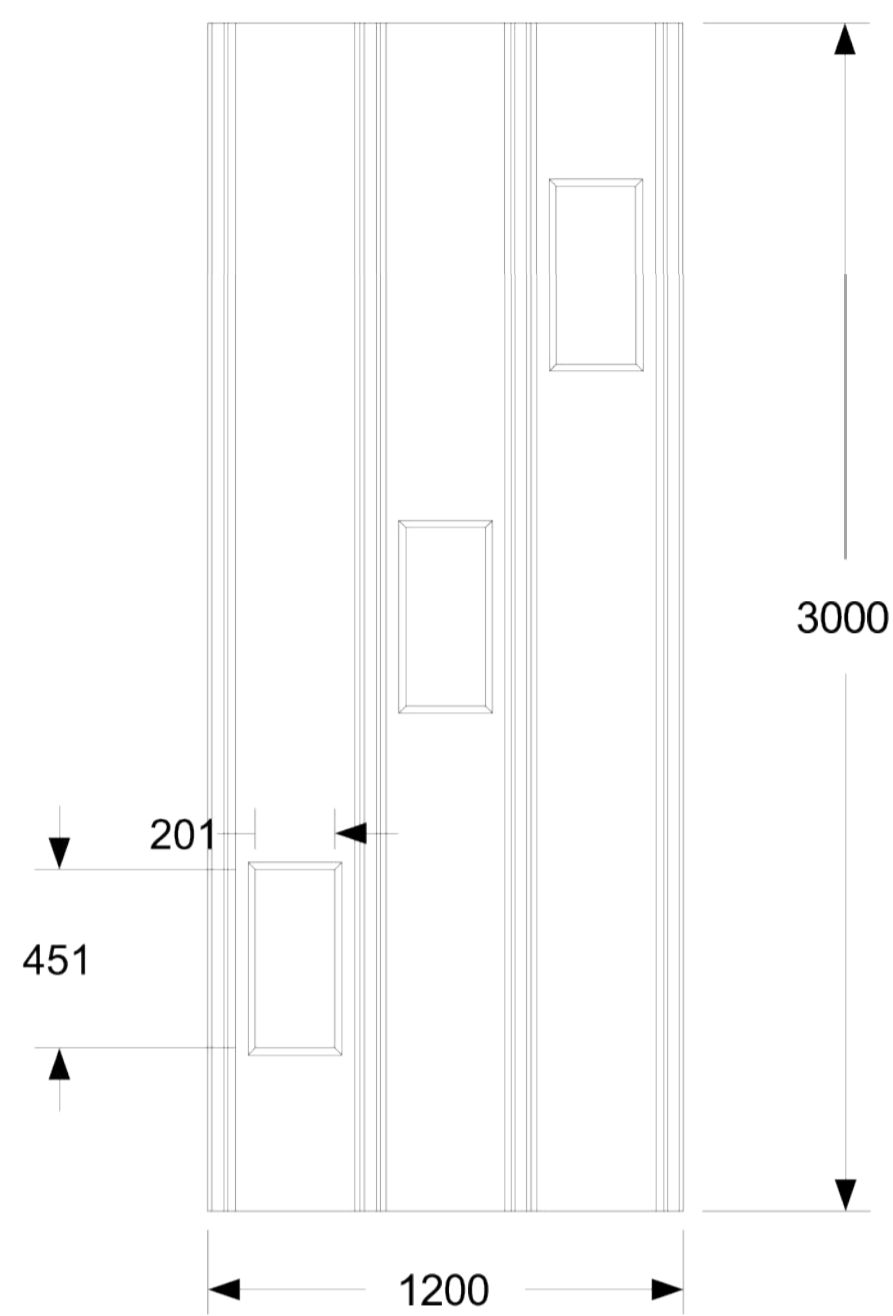
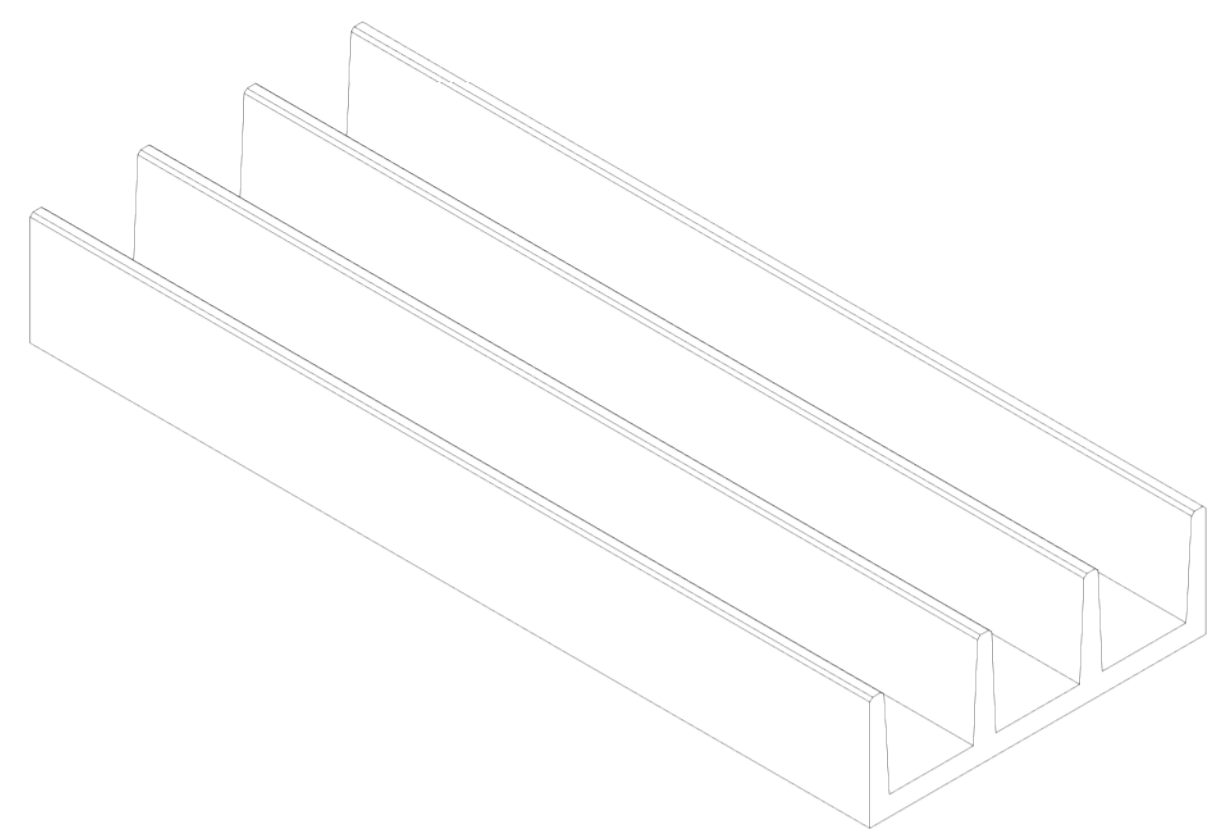

ARMERING:

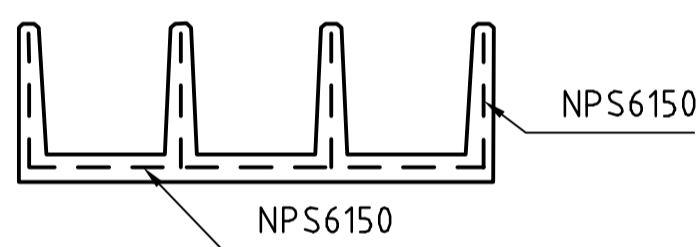

SEKTION:

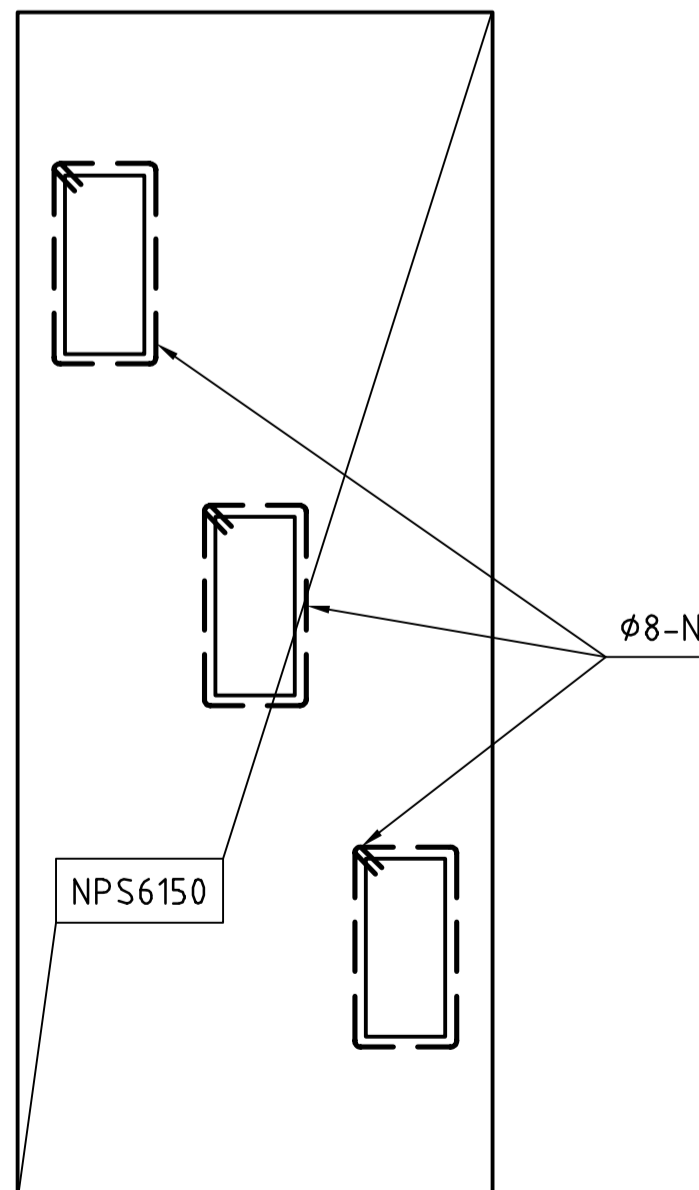

PLAN:

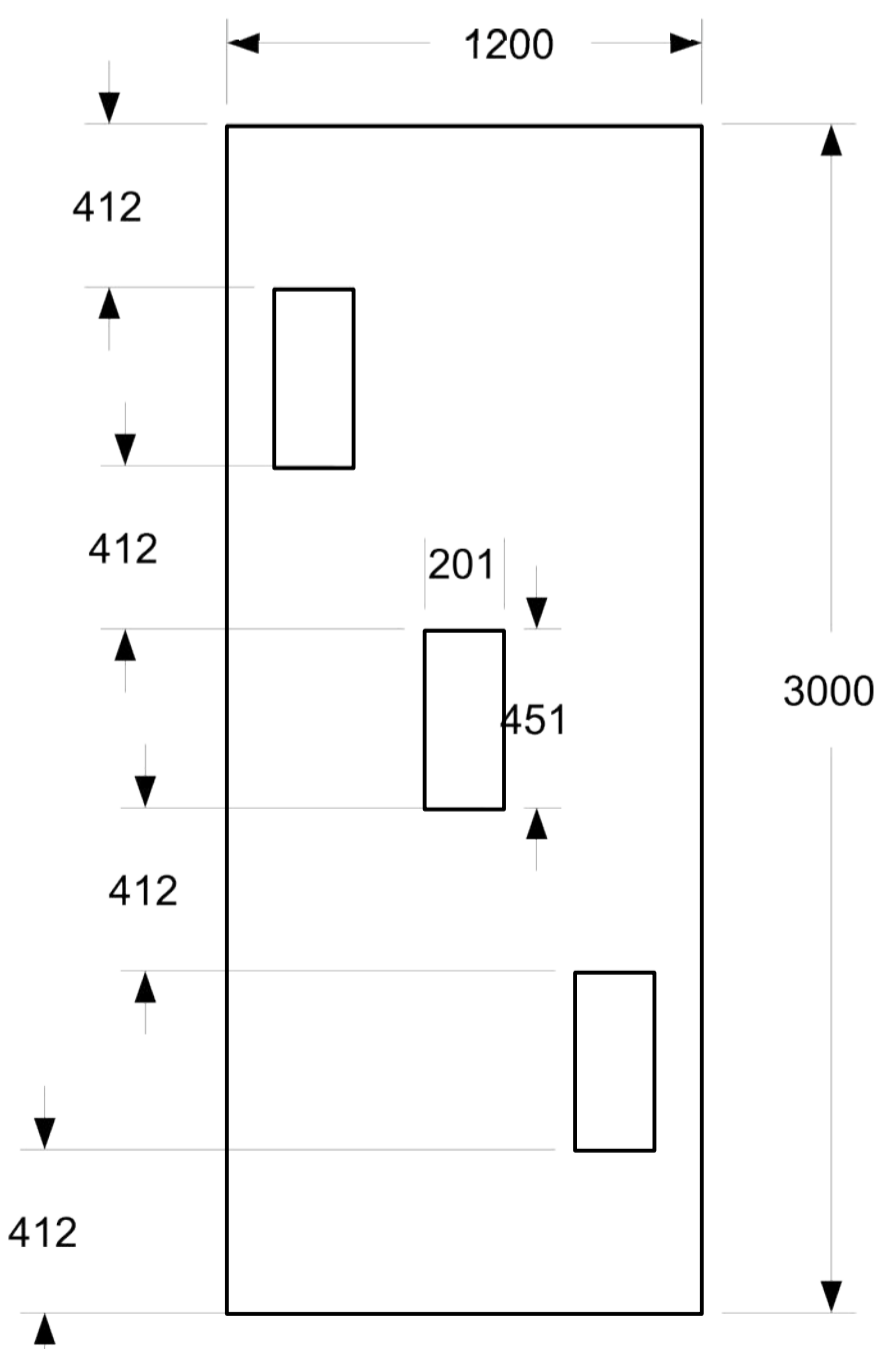

REVISION HISTORY				
ZONE	REV	DESCRIPTION	DATE	APPROVED
ALLMÄNNA ANVISNINGAR: BBR 19 EKS 8 MED ÄNDRINGAR TOM EKS 11.				
SÄKERHETSKLASS 1 LIVSLÄNGDSKLASS L100 UTFÖRANDEKLASS 1 BETONGKVALITE: MIN 30/37, VCT=0,50 EXPONERINGSKLASS: XC4/XF3				
ARMERING: NÄT: NPS500 STÄNGER: B500BT TÄCKANDE BETONGSKIKT MIN 20mm				

E	A2	General Tolerances acc to: ISO 2768-1 medium	Drawn	Checked	Dat.	20240114
			A lohrdèn	Checked	REV	20210119
blixbo cementvarufabrik AB			Title		Sheet 1 of 1	Rev.
			kabelkanal		Doc.Nr	101