

The VELUX logo consists of the word "VELUX" in a bold, white, sans-serif font, with a registered trademark symbol (®) to its upper right. It is set against a solid red rectangular background.The word "Commercial" is written in a white, sans-serif font and is centered within a solid black rectangular background.The main title "VELUX Modular Rooflights" is displayed in a large, white, sans-serif font. The background of this section is a dark grey, almost black, gradient that transitions from the top image of the rooflights to the bottom footer area.

Daylight solutions for public and commercial buildings

Version 3.0

[veluxcommercial.se](http://veluxcommercial.se)



Front cover: Monolight

## Elegant rooflight in pure style for flat roofs

VELUX Modular Rooflights are roof windows for flat roofs, that maximise the amount of natural light, without intrusive framing being visible from beneath.

VELUX Modular Rooflights have an elegant and aesthetic design and bring daylight into commercial buildings – for learning, working and recovering. The modules are available made-to-measure and can be produced in any dimension within the design limits, to meet the specific needs.

**VELUX Modular Rooflights** come in the following configurations:

- Monolight** (Fixed and Venting)
- Monolight Walk-on** (Fixed)
- Linearlight** (Fixed and Venting)
- Circularlight** (Fixed without upstand)

Burglary-resistant variant is available for:

- Monolight** (Fixed and Venting)
- Linearlight** (Fixed)



Above: Linearlight, Residential buildings, Strandpromenaden, Østerbro, Denmark

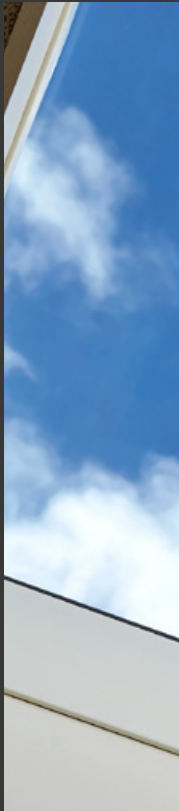



K.B. Hallen, Sports Facilities, Copenhagen, Denmark.

# Index

<b>VELUX Modular Rooflights</b>	<b>6</b>
Daylight through the roof as single spots or entire bands	8
<b>Made-to-measure premium rooflights</b>	<b>10</b>
The Module / Product overview	12
Module construction	14
Roof pitch and clear internal measurement	20
Product overview – features and limitations	22
Size overview	24
Attachment to the roof	27
<b>Performance and technical data</b>	<b>28</b>
Module materials	30
Glazing unit	32
Technical data	34
Classifications	36
Data plate	38
Venting module – Chain actuator, Electrical system	40
Venting module – Electrical components	42
Roller blinds / Size overview	44
Sectional drawings	50
<b>Installation</b>	<b>54</b>
Designed for easy installation	56
<b>Support</b>	<b>58</b>
Technical drawings, CAD/BIM objects	60
VELUX Daylight Visualizer	61
Design phase, Installation phase, Daily operation	62





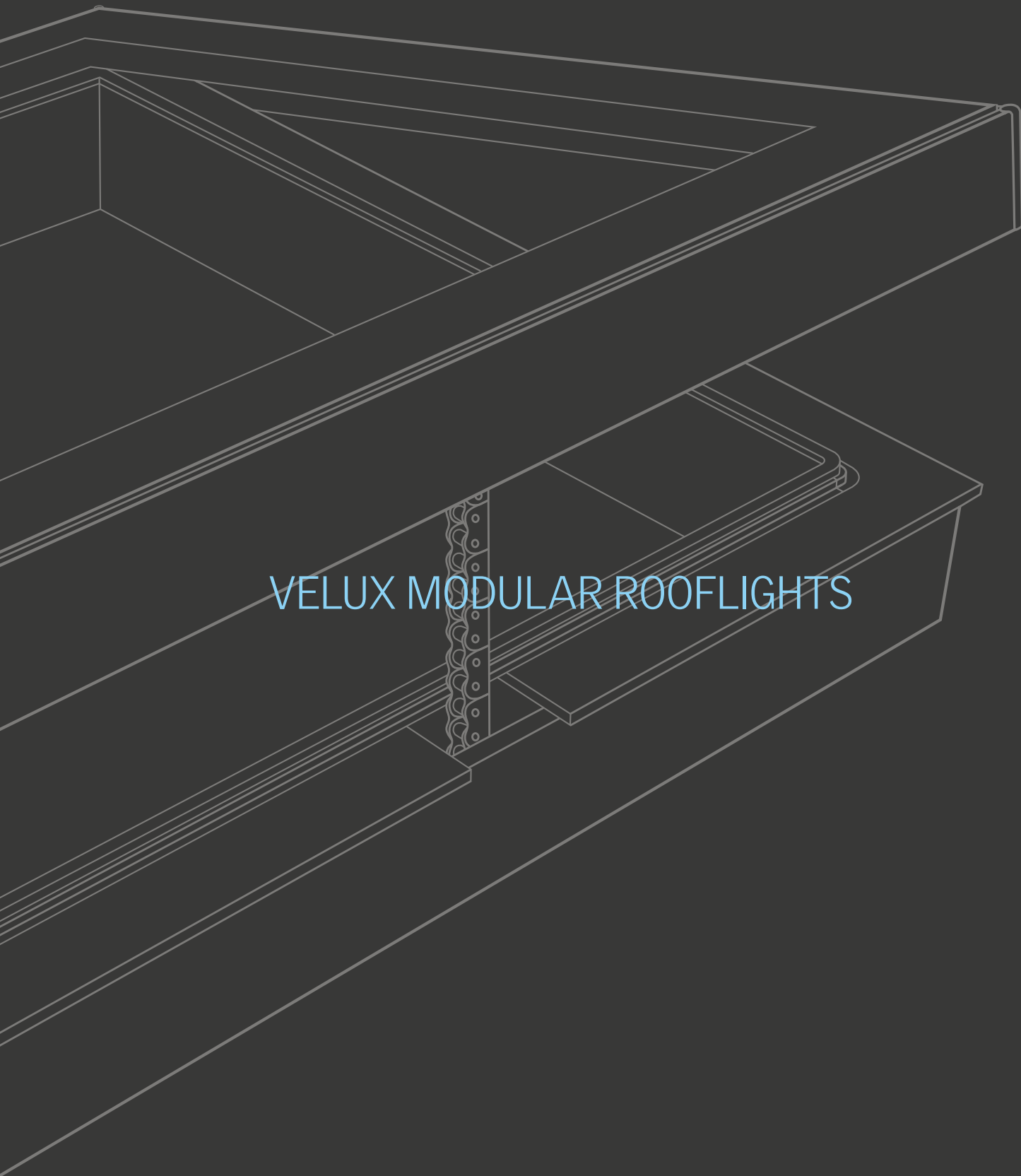

# VELUX MODULAR ROOFLIGHTS

## Daylight through the roof as single spots or entire bands



Monolight, K.B.Hallen Sports facilities, Copenhagen, Denmark

VELUX Modular Rooflights are an elegant solution for flat roofs, providing direct access to daylight. Due to the glass-top construction the light incidence is maximised, meaning that the light area is equal to the hole in the roof. Furthermore, the prefabricated built-in timber upstand provides a straightforward and simple installation process. VELUX Modular Rooflights consist of several variants:

- Monolight is a single rooflight which can transform a dull room by flooding the space with natural light from above. Monolight is offered as fixed or venting rooflight, allowing for additional comfort ventilation as required.





Linearlight, Residential buildings, Hellerup, Denmark

- Monolight Walk-on is offered as a fixed version intended for domestic applications. The walkable top unit can make flat roofs accessible without compromising daylight in the building.
- Linearlight is a row of VELUX Modular Rooflights that by means of an advanced connector system provides a larger band of natural light without the need for additional support.

Linearlight is offered as a fixed or venting rooflight, allowing for additional comfort ventilation as required.

- Circularlight is a fixed single round rooflight which can provide an elegant rounded style look in the roof. It is supplied without an upstand.

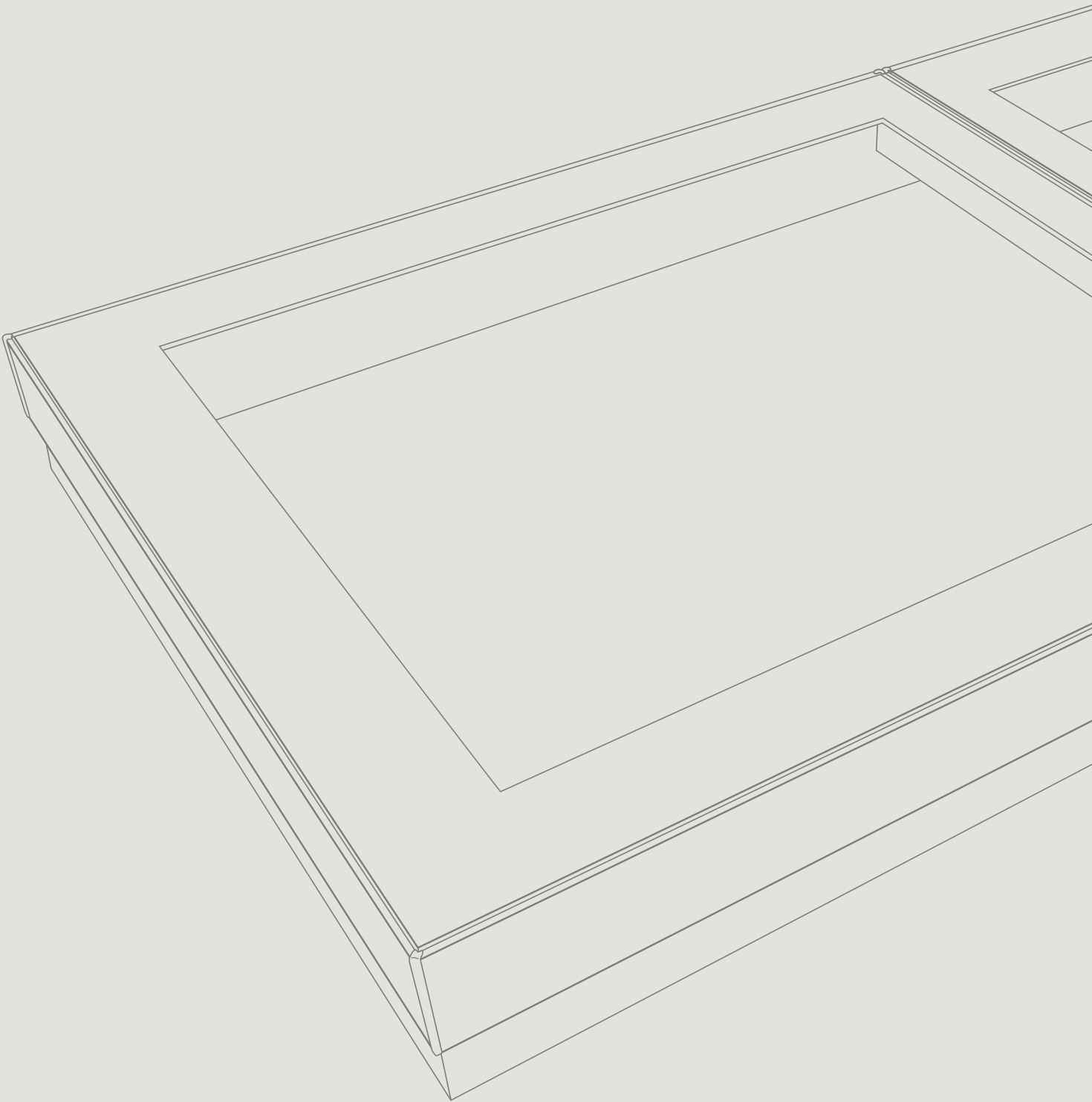

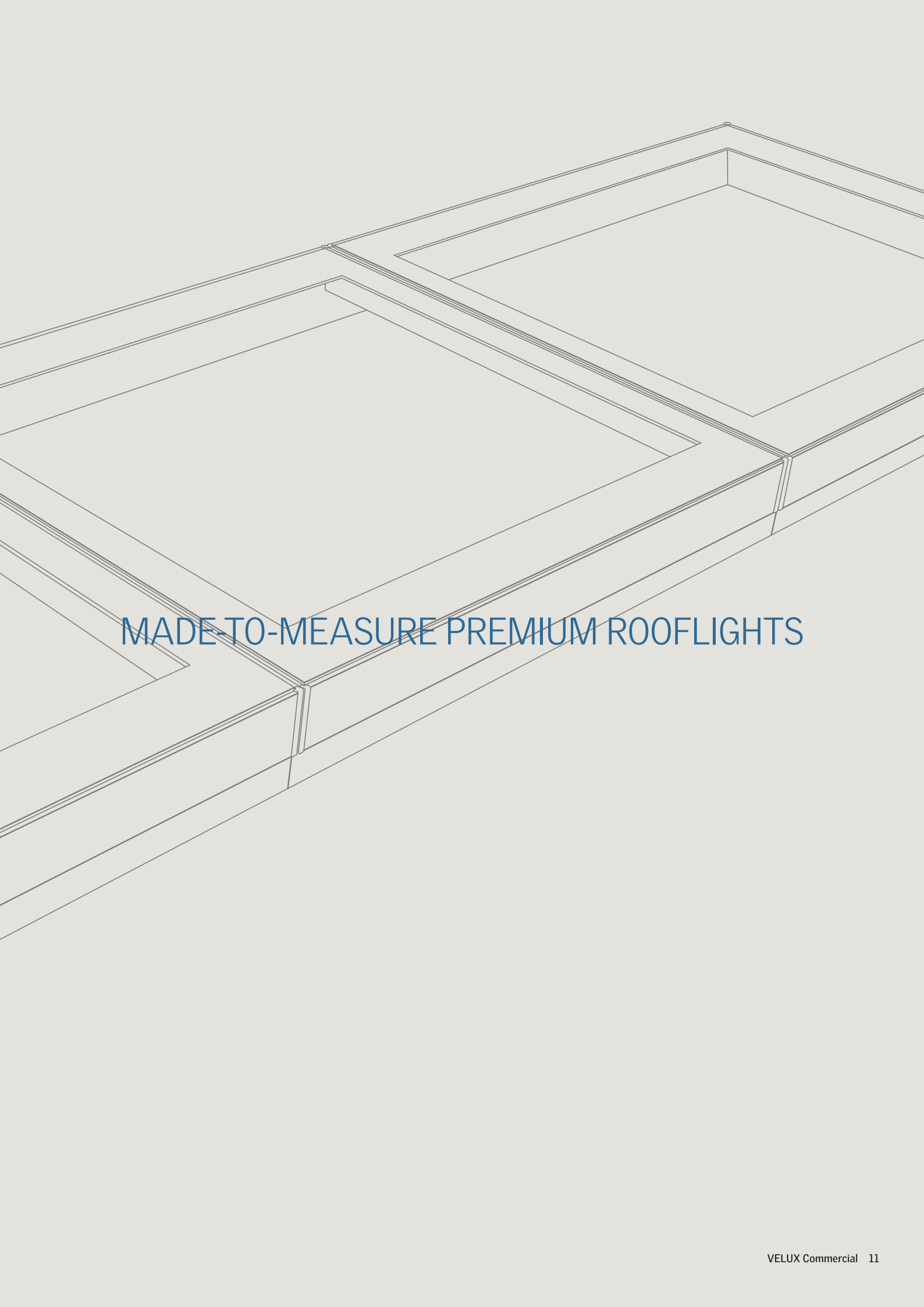

# MADE-TO-MEASURE PREMIUM ROOFLIGHTS

# The module

## The advantages of a prefabricated flat roof module

Prefabricated modularity offers a great number of advantages, at every step in the process. From planning and design to the moment the roof is sealed off with magnificent skylights. Modularity offers:

- Known performance, classifications and behaviour, easing the specification phase.
- Predictability of time frame and estimation of labour in the installation phase.
- Security for years to come through support and maintenance.
- Clarity and speed for all implicated stakeholders in the building process.

Modularity is a shortcut to creating sustainable buildings with all the necessary approvals and classifications.

### Modularity in every single product

All modules are produced offsite at our factory, meaning every single component is rigorously tested and integrated in a controlled environment. Each component is also of the highest premium quality and is built to stand the test of time.

All prefabricated Monolight and Linearlight roof windows are CE marked in accordance with EN 14351-1. Except for Circularlight where no upstand is included.

VELUX Modular Rooflights have a reference service life of 30 years in accordance with EN 17213.

For more on performance and classifications, go to page 28-37.

VELUX Modular Rooflights are made-to-measure modules and can be produced in any dimension and upstand height, within the design limits, thus perfectly to match the building.

## The two different types

### Indicated with light blue colour:

Monolight and Linearlight as standard fixed and venting versions are designed and certified as generation B.

### Indicated with dark blue colour:

Monolight Burglary-resistant, Monolight Walk-on, Linearlight Burglary-resistant and Circularlight are designed and certified as generation A.

## Product overview

### Monolight

Fixed

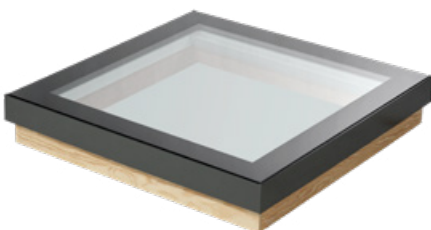

#### Monolight fixed

Is a non-venting variant, including upstand, and a perfect solution where natural light is desired. For a nice finish the builders inner lining can be connected into the groove just under the glazing.

Venting



#### Monolight venting

Is an optimal solution where light and natural ventilation are required. An elegant and functional solution, with a fully integrated chain actuator concealed within the insulated timber upstand. For a nice finish the builders inner lining can be connected into the groove just under the glazing.

## Linearlight

Fixed



Venting



### Linearlight fixed and/or venting

Linearlight is a unique solution that by placing modules side by side form a continuous system without the need for additional support. The solution consists of either pure fixed modules, pure venting modules or a combination of both, based on customer wishes.

The upstand with advanced connector system and drainage gutter ensures a watertight and airtight connection between the modules. A minimized beam ensures a beautiful connection on the inside. Based on customer requirements a static calculation (snow and windloads) will be made by VELUX Commercial for each building situation.

## Monolight Burglary-resistant

Fixed and venting

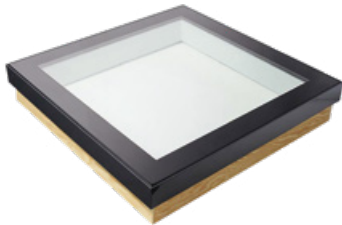

### Burglary-resistant

Is available as versions of Monolight fixed and venting and of Linearlight fixed. These products are approved according

## Linearlight Burglary-resistant

Fixed

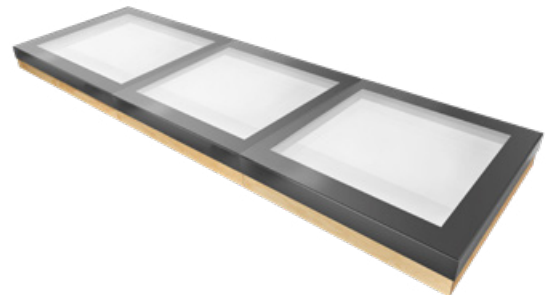

to EN 1627 and NEN 5096 Resistance Class 2. A vapour barrier is prefitted to the upstand.

## Monolight Walk-on

Fixed

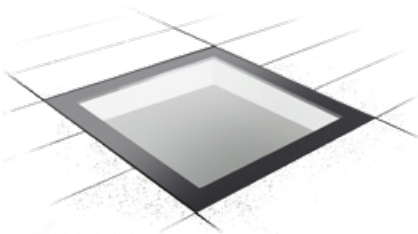

### Monolight Walk-on

Is a non-venting, single-unit rooflight intended for domestic application and ideal in case where natural light is required under an accessible roof. A vapour barrier is prefitted to the upstand.

## Circularlight \*

Fixed

\* No upstand included



### Circularlight

For buildings with a wish for an extraordinary architectural style or daylight design Circularlight can be applied to illuminate the room with natural light. Circularlight is supplied with top plate that can be applied on to builders kerb.

# Module construction

## Monolight

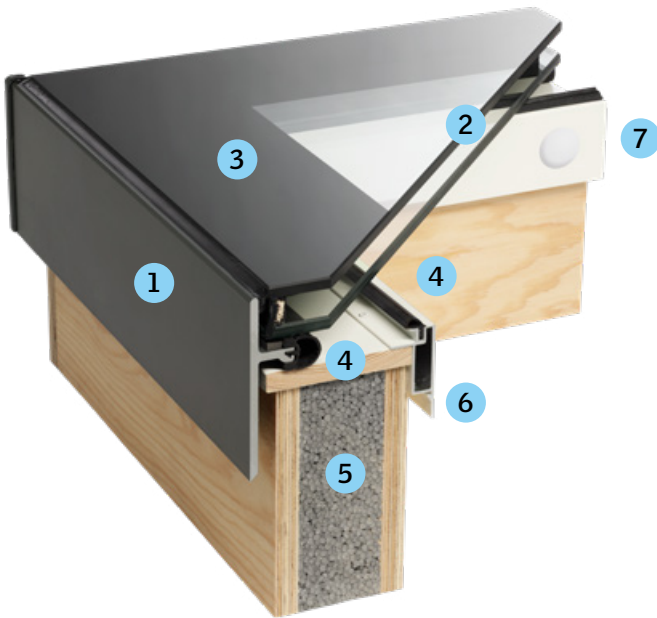

- 1 Aluminium frame (height vary depending on glazing unit)**  
Pre-assembled corners and powder coated aluminium frame with the standard colour RAL 7043, gloss 30.
- 2 Insulating Glass Unit (IGU)**  
Available in double and triple glazing, standard with LowE coating or with additional Sun protection.
- 3 Silk screen print**  
The silk screen print gives a nice finish as well as UV protection to the gaskets and the underlying construction.
- 4 Double gaskets**  
The gaskets on the aluminium profiles provide watertight and airtight construction.
- 5 Upstand**  
90° angle provides a straight connection with the interior. The timber-eps sandwich construction provides a stable and well-insulated upstand for a good insulating performance of the entire product.
- 6 Lining profile**  
This multifunctional part defines the clear internal part of the product. It offers the possibility for a secure connection to the vapour barrier in the roof construction. It also makes the flush plaster board connection from ceiling to glazing easy and intuitive during installation. Vapour barrier and inner lining are to be supplied by others. The profile also supports installation of an optional roller blind.
- 7 Pre-wiring for roller blind**  
Hidden pre-wiring is optional for nice and easy installation of VELUX roller blinds.

# Linearlight

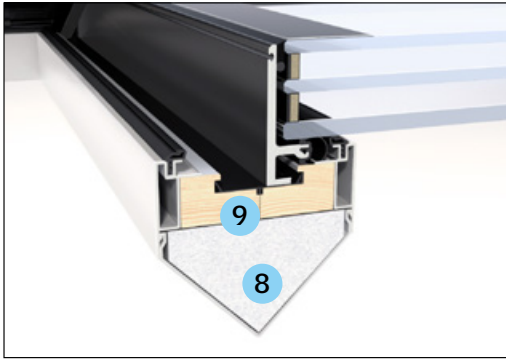
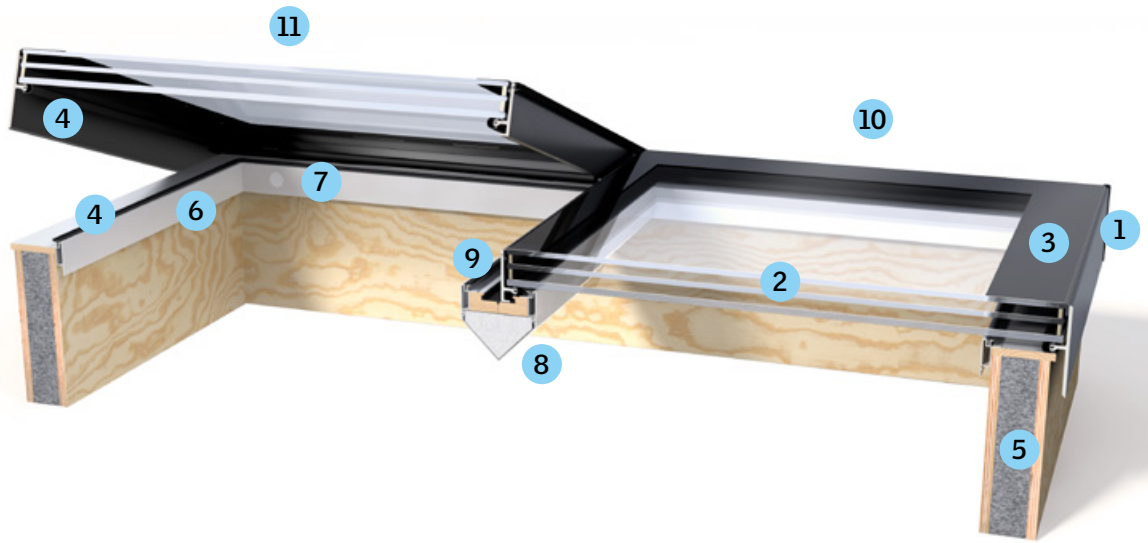

- 1 Aluminium frame (height vary depending on glazing unit)**  
Pre-assembled corners and powder coated aluminium frame with the standard colour RAL 7043, gloss 30.
- 2 Insulating Glass Unit (IGU)**  
Available in double and triple glazing, standard with LowE coating or with additional Sun protection.
- 3 Silk screen print**  
The silk screen print gives a nice finish as well as UV protection to the gaskets and the underlying construction.
- 4 Double gaskets**  
The gaskets on the aluminium profiles provide watertight and airtight construction.
- 5 Upstand**  
90° angle provides a straight connection with the interior. The timber-EPS sandwich construction provides a stable and well-insulated upstand for a good insulating performance of the entire product.

- 6 Lining profile**  
This multifunctional part defines the clear internal part of the product. It offers the possibility for a secure connection to the vapour barrier in the roof construction. It also makes the flush plaster board connection from ceiling to glazing easy and intuitive during installation. Vapour barrier and inner lining are to be supplied by others. The profile also supports installation of an optional roller blind.
- 7 Pre-wiring for roller blinds**  
Hidden pre-wiring is optional for nice and easy installation of VELUX roller blinds.
- 8 Minimized beam**  
The beam with optimized reinforcement is supporting the top unit while it is kept as slim as possible in order to maximize light entrance.
- 9 Drainage gutter**  
Rain water flows down the drainage gutter and is transported to the outside of the product.
- 10 Fixed module**
- 11 Venting module**

# Module construction

## Monolight & Linearlight – Burglary-resistant

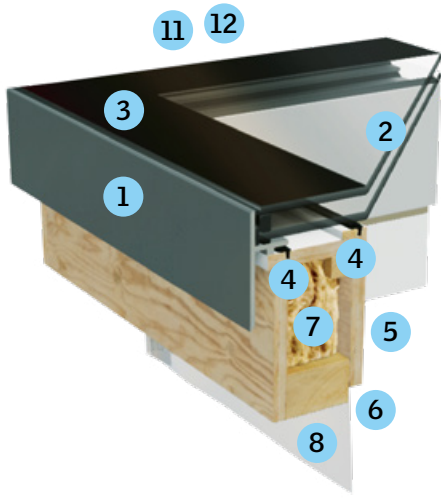

**Monolight** – Burglary-resistant

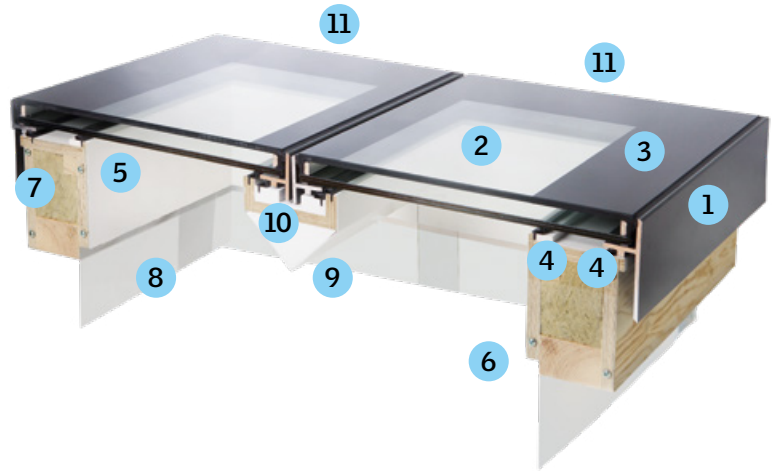

**Linearlight** – Burglary-resistant

### Applies to Monolight and Linearlight – Burglary-resistant

- 1 Aluminium frame (height vary depending on glazing unit)**  
Welded corners and powder coated aluminium frame with the standard colour RAL 7043, gloss 30
- 2 Insulating Glass Unit (IGU)**  
Available in double and triple glazing, standard with LowE coating or with additional Sun protection.
- 3 Silk screen print**  
The silk screen print gives a nice finish as well as UV protection to the gaskets and the underlying construction
- 4 Double gaskets**  
The gaskets on the timber upstand provide watertight and airtight construction
- 5 Internal lining**  
90° lining defining the clear internal part of the product and provides a great connection with the interior
- 6 Lining groove**  
Makes the plaster board connection easy and intuitive during installation
- 7 Insulating mineral wool**  
Insulation material in the frame ensures a good insulating performance of the entire product
- 8 Vapour barrier**  
The pre-fitted vapour barrier ensures an easy and secure connection to the vapour barrier in the roof construction

### Applies to Linearlight – Burglary-resistant

- 9 Minimized beam**  
The beam is supporting the top unit while it is kept as slim as possible in order to maximize light entrance
- 10 Drainage gutter**  
Rain water flows down the drainage gutter and is transported to the outside of the product
- 11 Fixed module**

### Applies to Monolight – Burglary-resistant

- 11 Fixed module**
- 12 Venting module**



## Monolight Walk-on

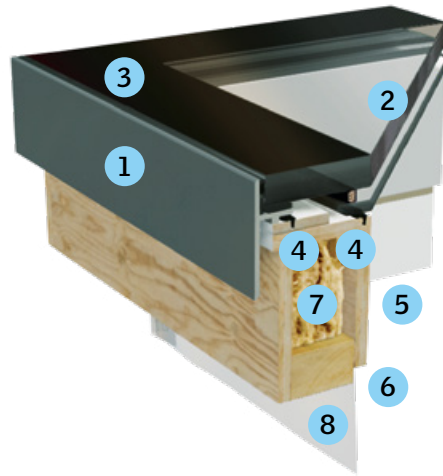

- 1 Aluminium frame (height varies depending on glazing unit)**  
Welded corners and powder coated aluminium frame with the standard colour RAL 7043, gloss 30
- 2 Insulating Glass Unit (IGU), double glazing**  
**Outer 3-layer toughened laminated glass:**  
Special walk-on glass construction (EVA Foil) with step.  
**Inner 2-layer laminated glass:**  
With PVB foil. Space between outer and inner glass is filled with air. An anti-slip coating is optional.
- 3 Silk screen print**  
Gives a nice finish as well as UV protection to the gaskets and the underlying construction
- 4 Double gaskets**  
On the timber upstand provide watertight and airtight construction
- 5 Internal lining**  
90° lining defining the clear internal part of the product and provides a great connection with the interior
- 6 Lining groove**  
Makes the plaster board connection easy and intuitive during installation
- 7 Insulating mineral wool**  
Insulation material in the frame ensures a good insulating performance of the entire product
- 8 Vapour barrier**  
The pre-fitted vapour barrier ensures an easy and secure connection to the vapour barrier in the roof construction

## Circularlight

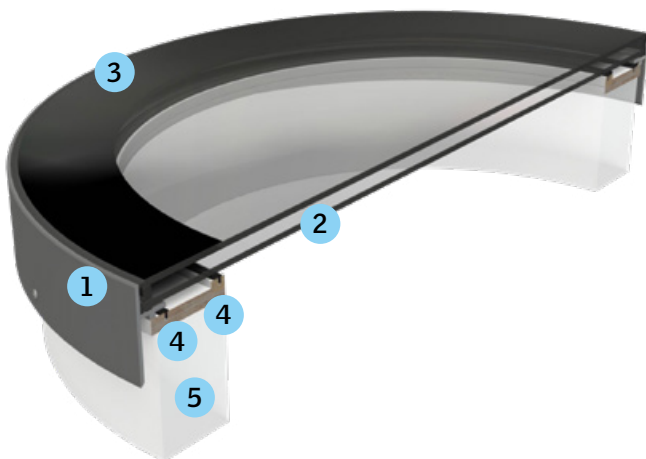

- 1 Aluminium frame**  
Welded frame and powder coated aluminium frame with the standard colour RAL 7043, gloss 30
- 2 Insulating Glass Unit (IGU)**  
Available in double glazing with LowE coating
- 3 Silk screen print**
- 4 Double gaskets**  
A top plate with gaskets provides a watertight and airtight construction
- 5 Upstand/sub-construction**  
Not supplied by VELUX Commercial

## Burglary-resistant variants Class 2 (RC2)

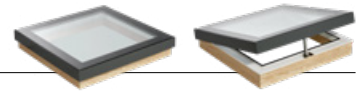

Stronger fixation of the top unit to upstand and roof.

Occasionally the government or building owner will require a burglar resistant building. It is important to have a product or system that is tested according to European standards and has achieved the correct classification.

Monolight (fixed and venting) and Linearlight (fixed) are available as a Burglary-resistant versions. The products are reinforced with stronger glass (P4A), fixation and additional installation materials. The approved security materials are supplied within the package.

Burglar resistant glazing code P4A: See page 34-35 for further details.

Performance

EN 1627:2011 & NEN 5096-2012+A1:2015: Class 2 (RC2)



Read more about burglary-resistance in our installation instruction  
Can be downloaded at: [veluxcommercial.se](http://veluxcommercial.se)

## Monolight Walk-on

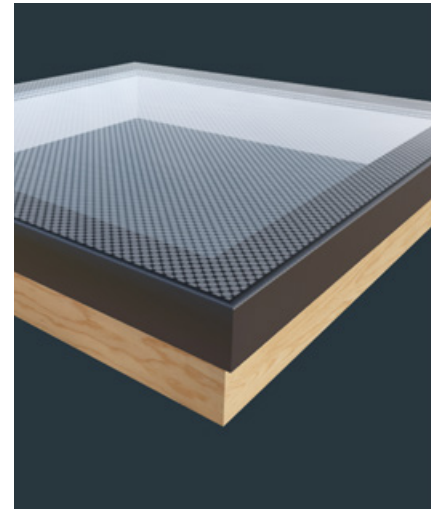
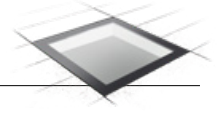

Anti-slip coating

### Monolight Walk-on

In case the room under an accessible roof needs natural light, the Monolight Walk-on is the ideal solution. This product is a solution for domestic application, so people can step on or walk along the rooflight, when the roof is accessible and a rooflight is placed in that area.

Modular Rooflights Walk-on with pedestrian walkability are only intended for light residential or light commercial use. They are not intended to be installed for industrial use, or in any other public or domestic situation where for instance driving through, use of cleaning agents, detergents and other chemicals may occur.

Monolight Walk-on is available as a double layer glazing unit with optional anti-slip feature.

Walk-on glazing construction; outer 3-layer toughened laminated glass (EVA Foil) with step, inner 2-layer laminated glass (PVB foil), space between outer and inner glass is filled with air.

VELUX Modular Rooflights Walk-on is supplied with an upstand and is CE marked according to EN 14351-1.

## Circularlight



### Circularlight

For buildings with an extraordinary architectural style Circularlight can be applied to illuminate with natural light. The round shape can on its own or combined in a pattern give a stylish expression to the building from outside or from the interior.

VELUX Modular Rooflights Circularlight is supplied without an upstand thus it is not CE marked. It is recommended to construct a stable upstand at a minimum height of 150 mm.

# Roof pitch and clear internal measurement

## Roof pitch

VELUX Modular Rooflights can be installed in flat and pitched roofs from 0° up to 15°. A minimum 5° pitch on the module installation is recommended to avoid ponding water on the glass surface.

The venting modules must be installed as top hung. A lateral pitch is not allowed for Venting modules or for Linearlight and Linearlight Burglary-resistant.

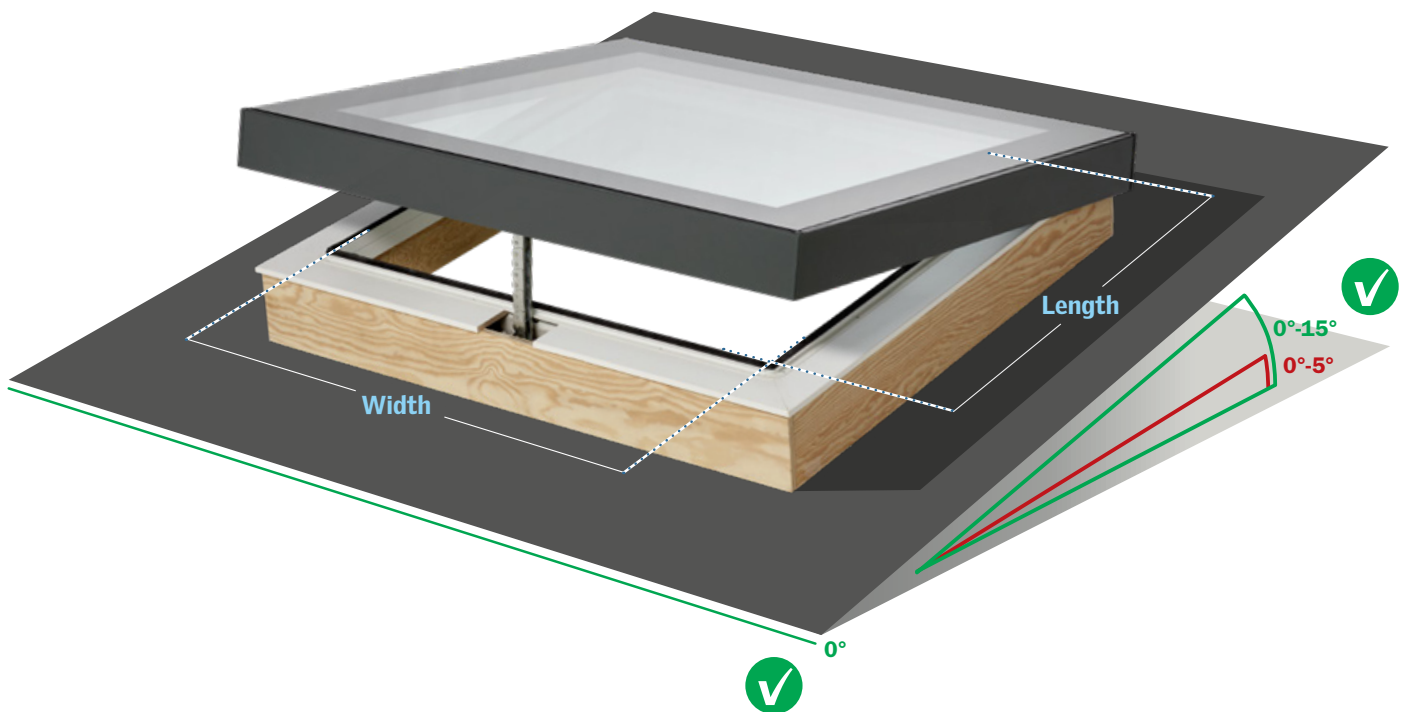

## Monolight and Linearlight

### Monolight



### Monolight/Linearlight

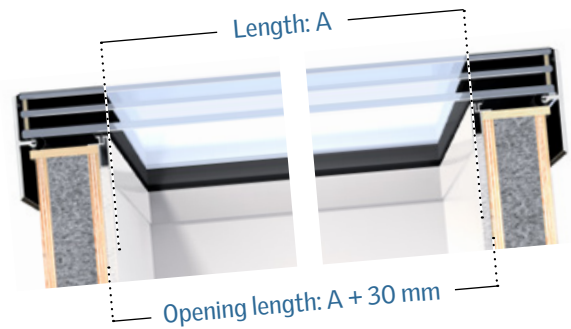

### Linearlight

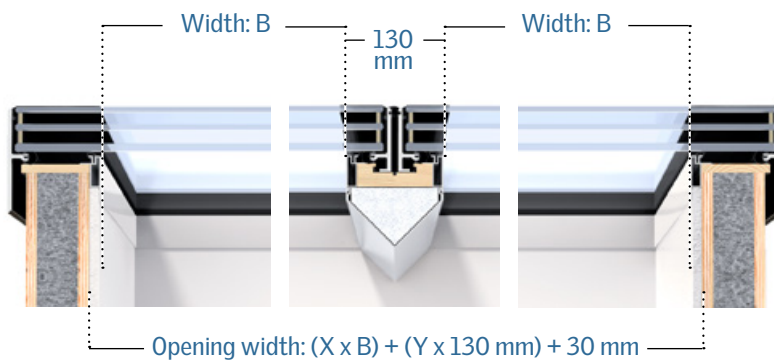

#### Clear Internal

A = Clear internal module length

B = Clear internal module width

Note: Inner lining to be supplied by others

## Monolight Burglary-resistant, Monolight Walk-on and Linearlight Burglary-resistant

### Monolight

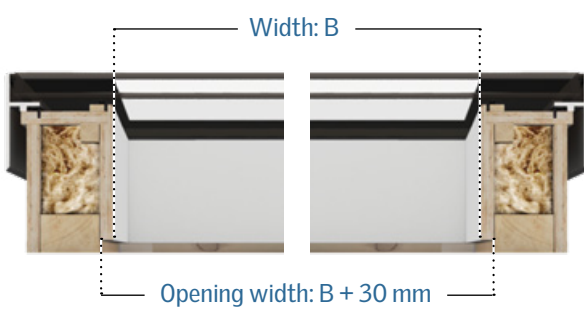

### Monolight/Linearlight

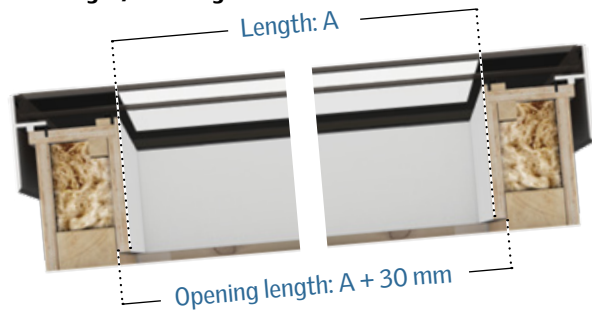

### Linearlight

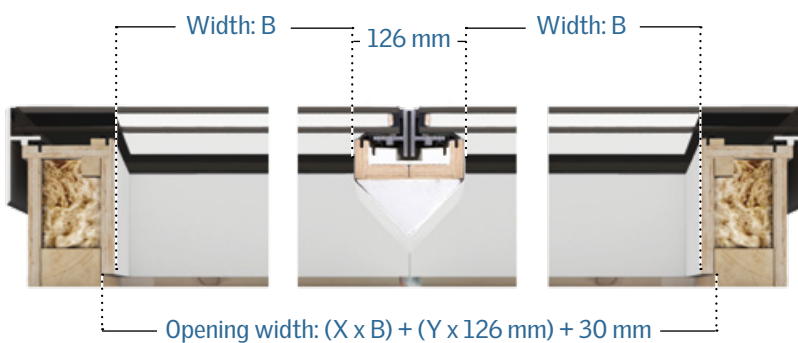

#### Clear Internal

A = Clear internal module length

B = Clear internal module width







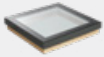

# Product overview

## The Module

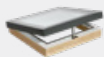
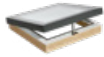
---



## Configuration options

			Glazing unit	Clear internal measurements (mm)		Upstand (mm)		Limitations				
				Width (B) (Actuator side) Diameter (Ø) (only Circularlight)	Length (A) (Slope direction)	Height	Construction width	Max. clear internal area (m <sup>2</sup> )	Max. measurement of shortest side (mm)	Max. ratio between shortest and longest side	Clear internal area (m <sup>2</sup> ) or width (B) in relation to one or two actuators	Min. width (B) for two actuators (mm)
<b>Monolight</b>	Fixed		Double glazing	250-3000	250-3000	150-600	100	4.00	1600	1:6	-	-
<b>Monolight</b>	Fixed		Triple glazing	250-3000	250-3000	150-600	100	4.00	1600	1:6	-	-
<b>Monolight</b>	Venting		Double glazing	600-3000	600-2000	150-600	100	4.00	1600	1:6	Area ≤ 2 m <sup>2</sup> (Single actuator) Area > 2 m <sup>2</sup> or width (B) > 2m (Dual actuators)	1200
<b>Monolight</b>	Venting		Triple glazing	600-3000	600-2000	150-600	100	3.00	1600	1:6	Area ≤ 1.5 m <sup>2</sup> (Single actuator) Area > 1.5 m <sup>2</sup> or width (B) > 2m (Dual actuators)	1200
<b>Linearlight</b>	Fixed		Double glazing	250-3000*	250-2000*	150-600	100	4.00*	1600	1:6	-	-
<b>Linearlight</b>	Fixed		Triple glazing	250-3000*	250-2000*	150-600	100	4.00*	1600	1:6	-	-
<b>Linearlight</b>	Venting		Double glazing	600-3000*	600-2000*	150-600	100	4.00*	1600	1:6	Area ≤ 2 m <sup>2</sup> (Single actuator) Area > 2 m <sup>2</sup> or width (B) > 2m (Dual actuators)	1330
<b>Linearlight</b>	Venting		Triple glazing	600-3000*	600-2000*	150-600	100	3.00*	1600	1:6	Area ≤ 1.5 m <sup>2</sup> (Single actuator) Area > 1.5 m <sup>2</sup> or width (B) > 2m (Dual actuators)	1330
<b>Monolight Walk-on</b> (domestic application)	Fixed		Walk-on Double glazing	250-2000	250-2000	150-600	100	2.00	-	1:6	-	-
<b>Circularlight</b> (upstand not included)	Fixed		Double glazing	Ø 900-1350	-	-	Topplate 107	1.43	-	-	-	-

\* Depends on snow and wind loads – a static calculation must be performed

Note: Monolight and Linearlight are including burglary-resistant versions

# Size overview

## Monolight – Made-to-measure

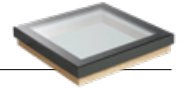

The table gives an indication of module size limits for all Monolight variants. Modules are made-to-measure and the size shall always be configured according to configuration options of criteria page 23.

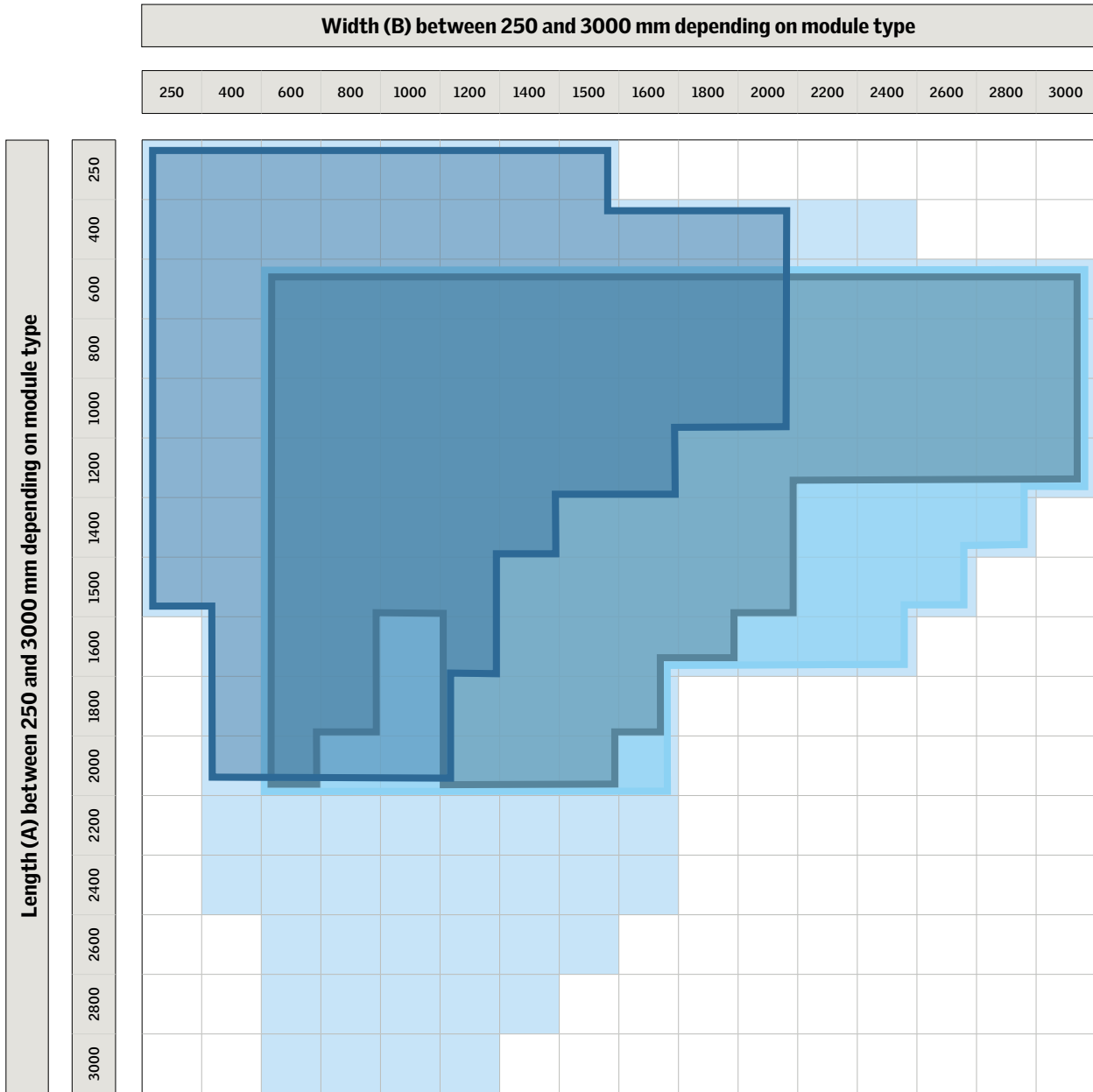

- Fixed modules**
- Venting modules**  
– Double glazing
- Venting modules**  
– Triple glazing
- Walk-on modules**



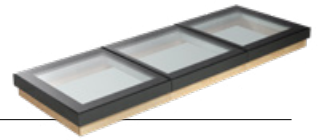

# Linearlight – Made-to-measure

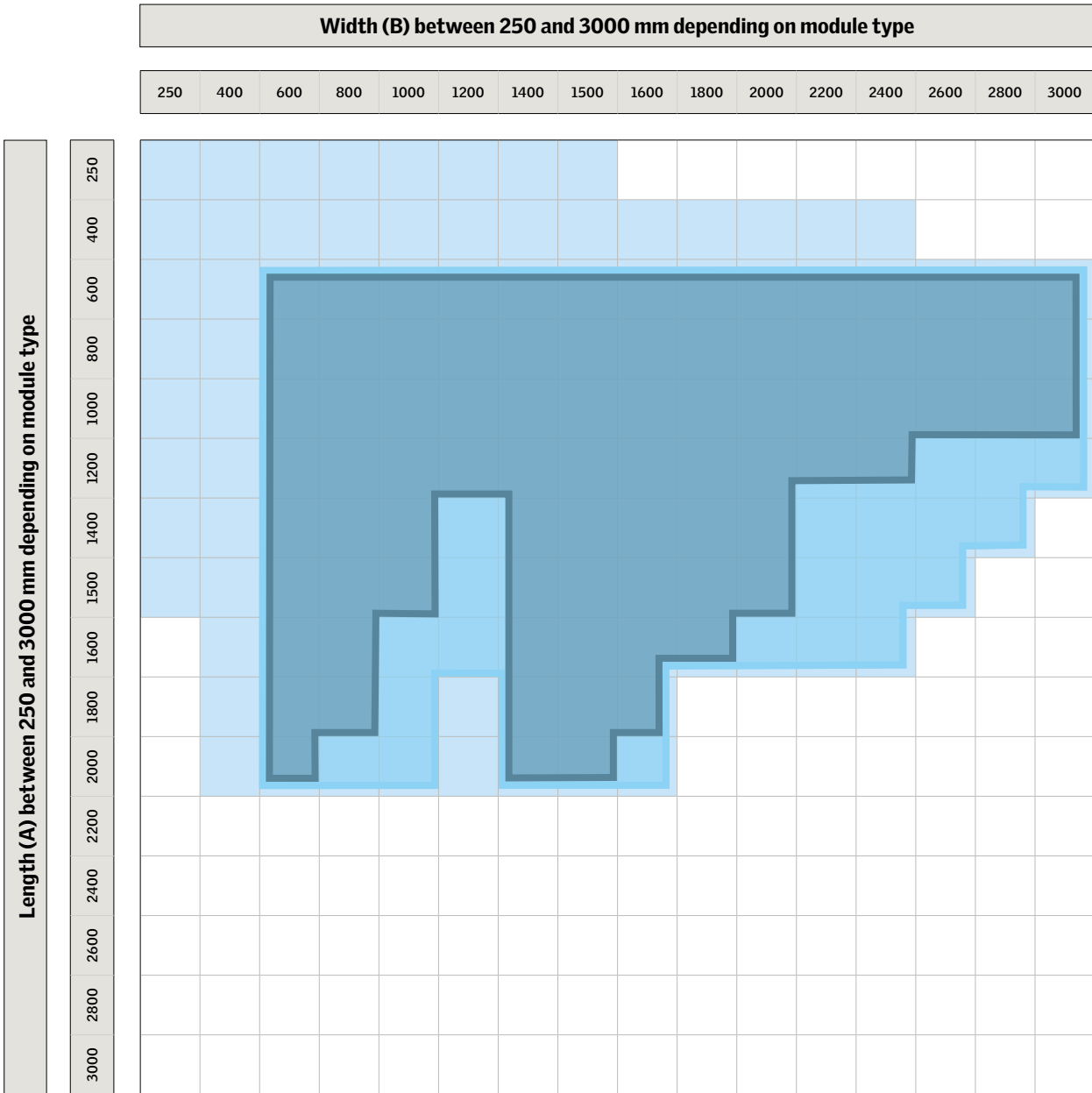

The table gives an indication of module size limits for all Linearlight variants. Modules are made-to-measure and the size shall always be configured according to configuration options of criteria page 23 and conform static calculation.



		<b>Fixed modules</b>
		<b>Venting modules</b> – Double glazing
		<b>Venting modules</b> – Triple glazing

# Size overview

## Circularlight – Made-to-measure



The table gives an indication of module size limits. Modules are made-to-measure and the size shall always be configured according to criteria page 23.

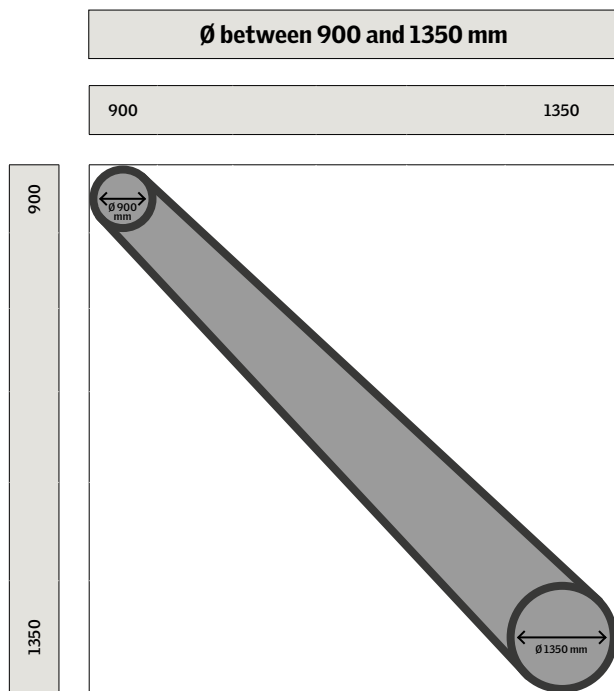

		<b>Circularlight modules</b> Sizes between: Ø 900 – 1350 mm
--	--	--

# Attachment to the roof

## Insulated timber upstand

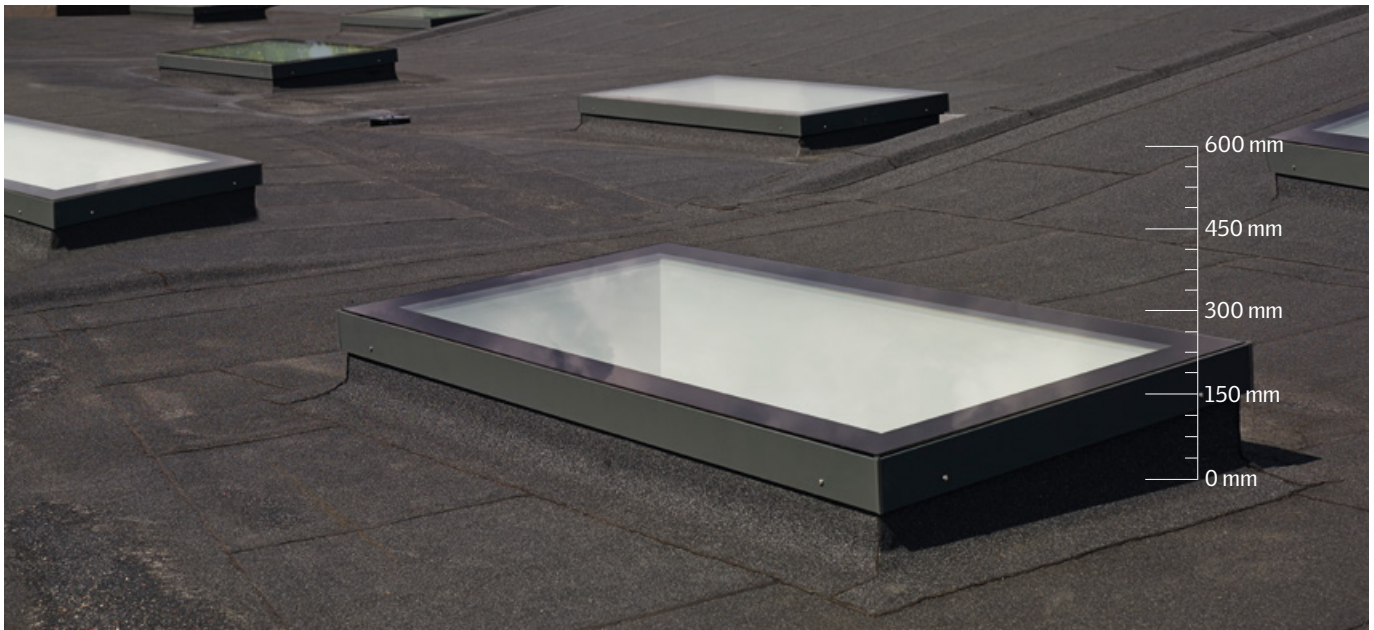
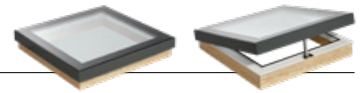

The timber upstand is supplied from 150 mm up to 600 mm, depending on project requirements, or visual architectural idea.

If 150 mm continuous roofing felt is needed, a minimum upstand height of 230 mm is required due to the top unit design. Though merely 190 mm if only fixed modules.

In venting modules, the actuator is fully integrated inside the timber upstand.

## Monolight and Linearlight

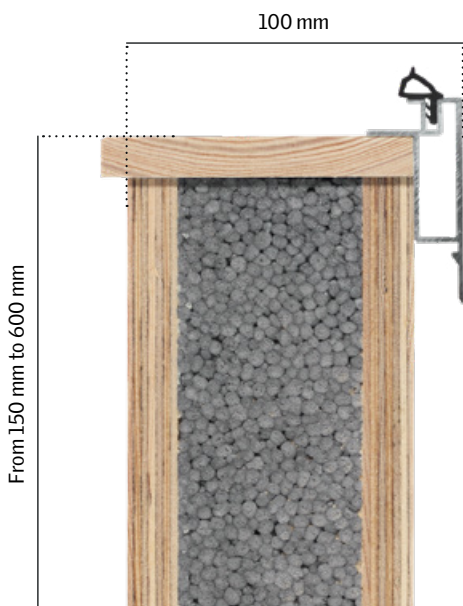

Inner lining and vapour barrier to be supplied by others.

## Monolight Burglary-resistant and Linearlight Burglary-resistant



Upstand includes vapour barrier and has white coated inner surface

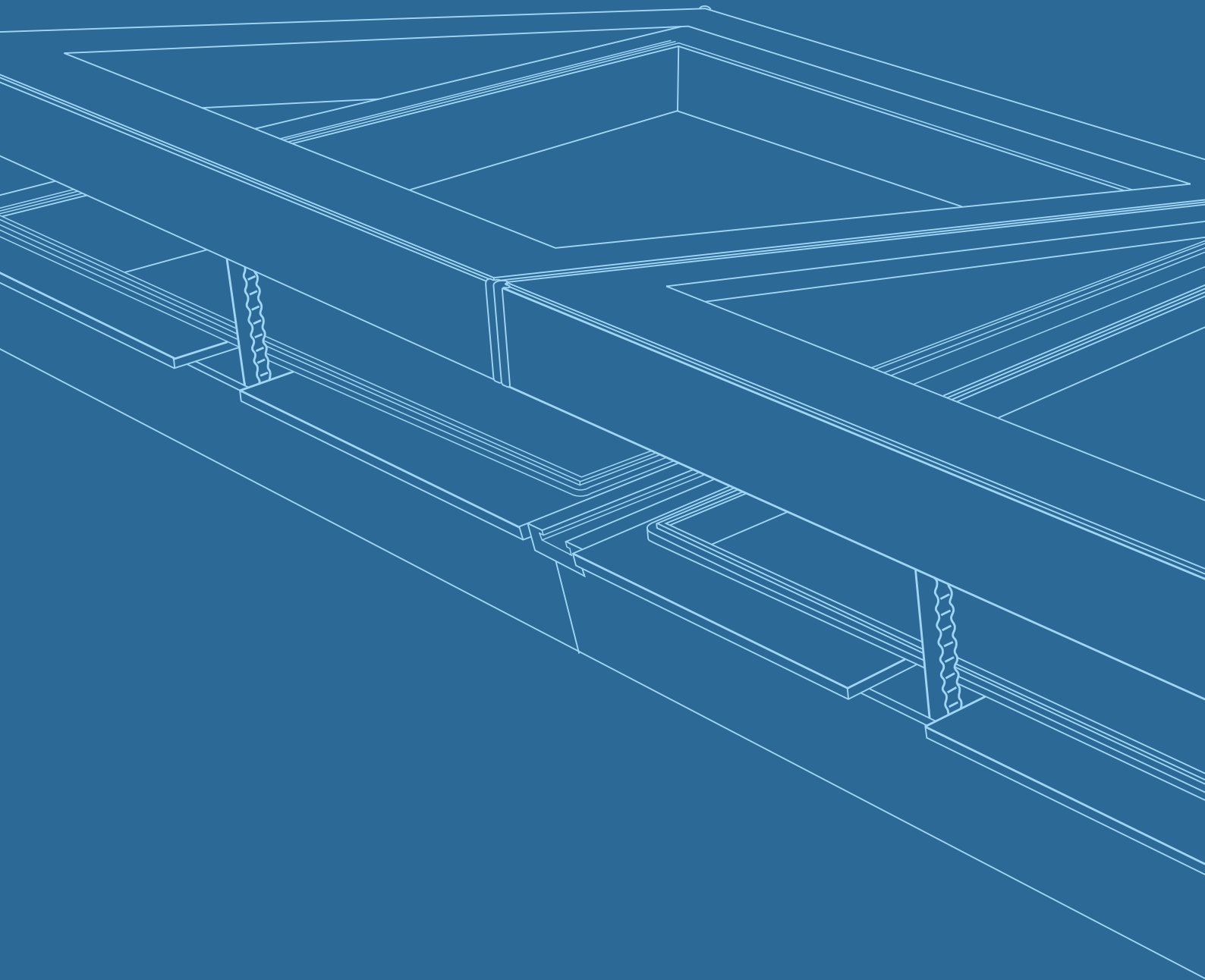

A technical line drawing of a window frame assembly, showing multiple layers and components in a perspective view. The drawing is composed of white lines on a blue background, illustrating the complex structure of the window frame.

## PERFORMANCE AND TECHNICAL DATA

# Module materials and colours

## Monolight and Linearlight, fixed and venting

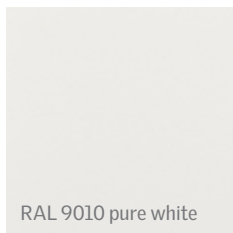
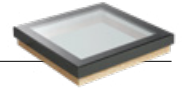

RAL 9010 pure white

### Insulated timber upstand

Material: Timber – EPS sandwich panel with timber and coated aluminium profile (RAL 9010 pure white, gloss 30)

#### Top surface:

- Water-resistant pine wood
- Waterbased white coating
- Colour: RAL 9010 pure white, gloss 30

#### Internal and external surface:

Water-resistant plywood untreated

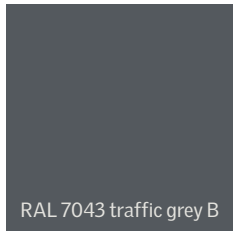

RAL 7043 traffic grey B

### Top unit

#### Frame:

Material: Aluminium (5 mm) with stainless steel corner keys

Surface: Powder coated

Colour: RAL 7043 traffic grey B, gloss 30 or RAL 9005 jet black, gloss 30. Other colours upon request at additional price.

Pane: Double or triple glazing

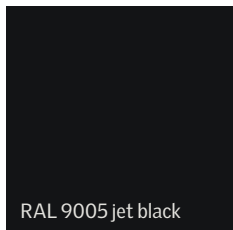

RAL 9005 jet black

## All modular rooflight modules



### Silk screen printing on pane

Material: Silk screen print, 115 mm wide (50 mm wide at beam side of Linearlight)  
Colour: Black



## Monolight Burglary-resistant, Monolight Walk-on and Linearlight Burglary-resistant

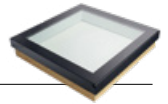

RAL 9010 pure white

### Insulated timber upstand

Material: Timber, mineral wool insulation and vapour barrier

### Internal surface and top:

- Water-resistant plywood
- Waterbased white coating
- Colour: RAL 9010 pure white, gloss 30

### External surface:

Water-resistant plywood untreated



RAL 7043 traffic grey B

### Top unit

#### Frame:

Material: Aluminium (5 mm)  
Surface: Powder coated  
Colour: RAL 7043 traffic grey B, gloss 30  
Pane: Double or triple glazing; for Walk-on only double glazing



## Circularlight

RAL 9010 pure white

### Top plate

Material: Water-resistant plywood

### Internal surface and top:

- Water-resistant plywood
- Waterbased white coating
- Colour: RAL 9010 pure white, gloss 30

RAL 7043 traffic grey B

### Top unit

#### Frame:

Material: Aluminium (5 mm)  
Surface: Powder coated  
Colour: RAL 7043 traffic grey B, gloss 30  
Pane: Double glazing

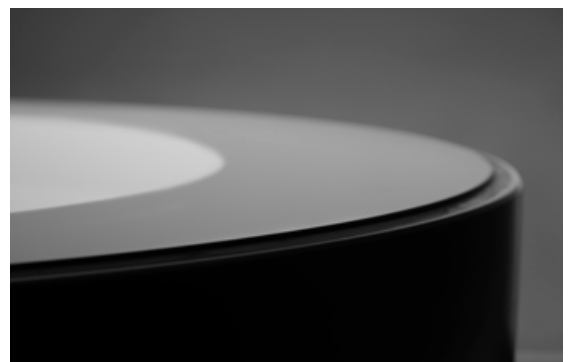

# Glazing unit

## Options

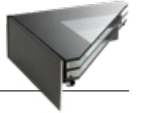

Modular rooflights come with low emissivity double or triple glazing with foil-laminated inner glazing for added safety and two different coating options.

The coatings are optimised to meet the desired levels of solar heat gain, sun protection, light transmittance and colour rendering.



**Double glazing available for**  
Monolight fixed and venting  
Linearlight fixed and venting

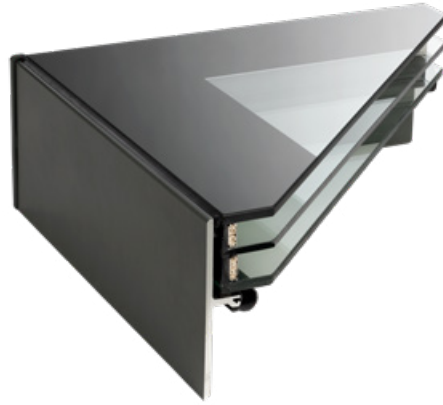

**Triple glazing available for**  
Monolight fixed and venting  
Linearlight fixed and venting



**Double glazing available for Burglary-resistant**  
Monolight fixed and venting  
Linearlight fixed



**Triple glazing available for Burglary-resistant**  
Monolight fixed and venting  
Linearlight fixed



**Walkable double glazing available for**  
Monolight Walk-on

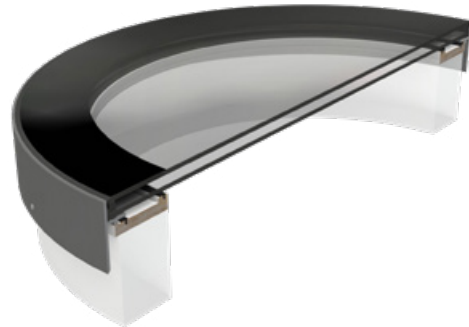

**Double glazing available for**  
Circularlight



# Glazing unit with advanced sun protection coating

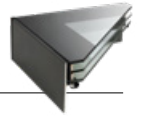

Spectral values (wave length in nm)

Visible daylight      tau

All of the mentioned values on this page are in accordance with EN 410.

## Glazing with low emissivity coating (LowE) for DG

### Variant 20V

Light transmittance:  $\tau_v$ -value = 80%  
 Solar factor: g-value = 61%  
 Colour rendering index:  $R_a$  = 97

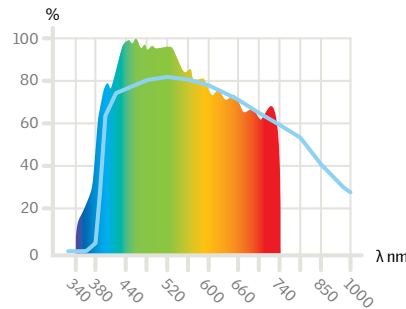

## Glazing with light sun protection coating (Sun1) for DG

### Variant 21V

Light transmittance:  $\tau_v$ -value = 61%  
 Solar factor: g-value = 33%  
 Colour rendering index:  $R_a$  = 91

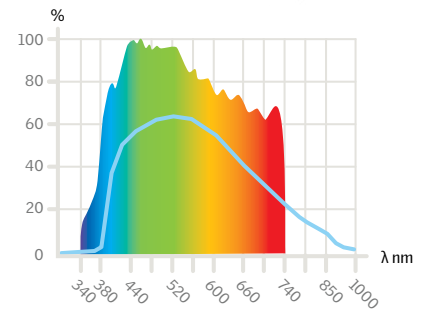

## Glazing with low emissivity coating (LowE) for TG

### Variant 30V

Light transmittance:  $\tau_v$ -value = 71%  
 Solar factor: g-value = 53%  
 Colour rendering index:  $R_a$  = 95

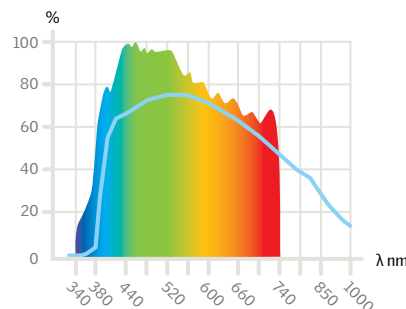
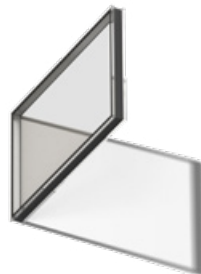

## Glazing with light sun protection coating (Sun1) for TG

### Variant 31V

Light transmittance:  $\tau_v$ -value = 55%  
 Solar factor: g-value = 31%  
 Colour rendering index:  $R_a$  = 90

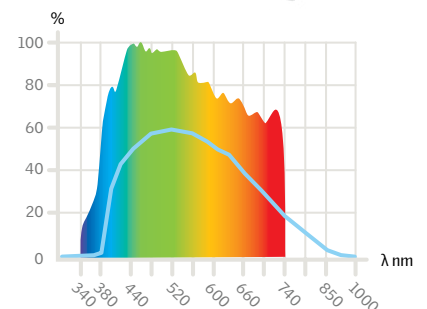
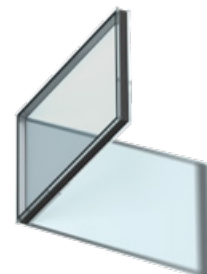

# Technical data

## Glazing Unit

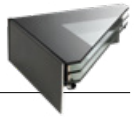

		<b>Monolight Linearlight</b>			<b>Monolight Burglary-resistant Linearlight Burglary-resistant</b>
		<b>Monolight Walk-on</b>			<b>Circularlight</b>

DG = Double Glazing TG = Triple Glazing WG = Walk-on glazing WAG = Walk-on anti-slip glazing	Coating	Insulating Glass Unit (IGU)	Clear internal area	Construction		Thermal transmittance	Light transmittance	Solar factor
				Insulating Glass Unit (IGU)				
				IGU code	a m <sup>2</sup>			

DG	LowE	20V	a ≤ 2 m <sup>2</sup>	8H - 16 Argon - 8.76F LowE (44.2)	1.1	80	61
DG	LowE	20Y	2 m <sup>2</sup> < a ≤ 2.8 m <sup>2</sup>	8H - 14 Argon - 10.76F LowE (55.2)	1.1	80	61
DG	LowE	20Z	2.8 m <sup>2</sup> < a ≤ 4.0 m <sup>2</sup>	8H - 12 Argon - 12.76F LowE (66.2)	1.1	79	61
DG	LowE	22V	a ≤ 2 m <sup>2</sup>	8H - 16 Argon - 9.52F LowE (44.4)	1.1	80	61
DG	LowE	22Y	2 m <sup>2</sup> < a ≤ 2.8 m <sup>2</sup>	8H - 14 Argon - 11.52F LowE (55.4)	1.1	79	61
DG	LowE	22Z	2.8 m <sup>2</sup> < a ≤ 4.0 m <sup>2</sup>	8H - 12 Argon - 13.52F LowE (66.4)	1.2	79	61

DG	Sun1	21V	a ≤ 2 m <sup>2</sup>	8H Sun1- 16 Argon - 8.76F LowE (44.2)	1.0	61	33
DG	Sun1	21Y	2 m <sup>2</sup> < a ≤ 2.8 m <sup>2</sup>	8H Sun1 - 14 Argon - 10.76F LowE (55.2)	1.0	61	33
DG	Sun1	21Z	2.8 m <sup>2</sup> < a ≤ 4.0 m <sup>2</sup>	8H Sun1 - 12 Argon - 12.76F LowE (66.2)	1.2	60	33
DG	Sun1	23V	a ≤ 2 m <sup>2</sup>	8H Sun1 - 16 Argon - 9.52F LowE (44.4)	1.0	61	33
DG	Sun1	23Y	2 m <sup>2</sup> < a ≤ 2.8 m <sup>2</sup>	8H Sun1 - 14 Argon - 11.52F LowE (55.4)	1.0	61	33
DG	Sun1	23Z	2.8 m <sup>2</sup> < a ≤ 4.0 m <sup>2</sup>	8H Sun1 - 12 Argon - 13.52F LowE (66.4)	1.2	60	33

TG	LowE	30V	a ≤ 2 m <sup>2</sup>	8H - 18 Argon - 6H LowE - 18 Argon - 10.76F LowE (55.2)	0.5	71	53
TG	LowE	30Y	2 m <sup>2</sup> < a ≤ 2.8 m <sup>2</sup>	8H - 16 Argon - 6H LowE - 18 Argon - 12.76F LowE (66.2)	0.5	71	52
TG	LowE	30Z	2.8 m <sup>2</sup> < a ≤ 4.0 m <sup>2</sup>	8H - 15 Argon - 6H LowE - 15 Argon - 16.76F LowE (88.2)	0.6	70	52
TG	LowE	32V	a ≤ 2 m <sup>2</sup>	8H - 18 Argon - 6H LowE - 18 Argon - 11.52F LowE (55.4)	0.5	71	52
TG	LowE	32Y	2 m <sup>2</sup> < a ≤ 2.8 m <sup>2</sup>	8H - 16 Argon - 6H LowE - 18 Argon - 13.52F LowE (66.4)	0.5	71	52
TG	LowE	32Z	2.8 m <sup>2</sup> < a ≤ 4.0 m <sup>2</sup>	8H - 15 Argon - 6H LowE - 15 Argon - 17.52F LowE (88.4)	0.6	70	52

TG	Sun1	31V	a ≤ 2 m <sup>2</sup>	8H Sun1 - 18 Argon - 6H - 18 Argon - 10.76F LowE (55.2)	0.5	55	30
TG	Sun1	31Y	2 m <sup>2</sup> < a ≤ 2.8 m <sup>2</sup>	8H Sun1- 16 Argon - 6H - 18 Argon - 12.76F LowE (66.2)	0.5	55	30
TG	Sun1	31Z	2.8 m <sup>2</sup> < a ≤ 4.0 m <sup>2</sup>	8H Sun1 - 15 Argon - 6H - 15 Argon - 16.76F LowE (88.2)	0.6	55	30
TG	Sun1	33V	a ≤ 2 m <sup>2</sup>	8H Sun1 - 18 Argon - 6H - 18 Argon - 11.52F LowE (55.4)	0.5	55	30
TG	Sun1	33Y	2 m <sup>2</sup> < a ≤ 2.8 m <sup>2</sup>	8H Sun1 - 16 Argon - 6H - 18 Argon - 13.52F LowE (66.4)	0.5	55	30
TG	Sun1	33Z	2.8 m <sup>2</sup> < a ≤ 4.0 m <sup>2</sup>	8H Sun1 - 15 Argon - 6H - 15 Argon - 17.52F LowE (88.4)	0.6	55	30

WG	LowE	25V	a ≤ 1 m <sup>2</sup>	25.04H (688.8) - 16 Air - 8.76F LowE (44.2)	1.3	74	50
WG	LowE	25Y	1 m <sup>2</sup> < a ≤ 1.5 m <sup>2</sup>	27.04H (888.8) - 16 Air - 10.76F LowE (55.2)	1.3	73	49
WG	LowE	25Z	1.5 m <sup>2</sup> < a ≤ 2 m <sup>2</sup>	29.04H (8810.8) - 16 Air - 10.76F LowE (55.2)	1.3	73	49
WAG	LowE	26V	a ≤ 1 m <sup>2</sup>	25.04H (688.8) Anti-slip - 16 Air - 8.76F LowE (44.2)	1.3	NPD	NPD
WAG	LowE	26Y	1 m <sup>2</sup> < a ≤ 1.5 m <sup>2</sup>	27.04H (888.8) Anti-slip - 16 Air - 10.76F LowE (55.2)	1.3	NPD	NPD
WAG	LowE	26Z	1.5 m <sup>2</sup> < a ≤ 2 m <sup>2</sup>	29.04H (8810.8) Anti-slip - 16 Air - 10.76F LowE (55.2)	1.3	NPD	NPD

DG	LowE	20V	a ≤ 2 m <sup>2</sup>	8H - 16 Argon - 8.76F LowE (44.2)	1.1	80	61
----	------	-----	----------------------	-----------------------------------	-----	----	----

The glazing unit has a black silk screen print along the edge

\* Slope α = 90°

NPD = No Performance Determined

# Glazing Unit – continued

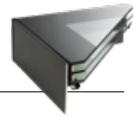

		<b>Monolight Linearlight</b>			<b>Monolight Burglary-resistant Linearlight Burglary-resistant</b>
		<b>Monolight Walk-on</b>			<b>Circularlight</b>

DG = Double Glazing TG = Triple Glazing WG = Walk-on glazing WAG = Walk-on anti-slip glazing	Coating	Insulatin Glass Unit (IGU)	Thermal transmittance of the entire window in accordance with EN 14351-1		Psi value	UVtransmittance	Colour rendering index	Direct airborn sound reduction (IGU) ***	Rain noise	Total solar energy direct absorption	Resistance to pendulum body impact (IGU) EN12600 ***	Security glazing (IGU) EN356 ***
			For clear internal area:									
			≤ 2.3 m <sup>2</sup> **	> 2.3 m <sup>2</sup> **								
			IGU	U <sub>w</sub>								
code	W/m <sup>2</sup> K	W/m <sup>2</sup> K	W/mK	%		dB	dB	%	Outside/Inside	Outside/Inside		

DG	LowE	20V	1.7	-	0.055	0.4	97	37 (-1,-5)	37	24	NPD/1B1	NPD/P2A
DG	LowE	20Y	1.7	1.6	0.055	0.4	96	39 (-2,-5)	39	25	NPD/1B1	NPD/P2A
DG	LowE	20Z	-	1.8	0.061	0.4	96	38 (0,-4)	38	26	NPD/1B1	NPD/P2A
DG	LowE	22V	1.7	-	0.055	NPD	97	38 (-1,-5)	38	25	NPD/1B1	NPD/P4A
DG	LowE	22Y	1.7	1.6	0.055	NPD	96	39 (-2,-5)	39	26	NPD/1B1	NPD/P4A
DG	LowE	22Z	-	1.8	0.061	NPD	96	38 (0,-4)	38	27	NPD/1B1	NPD/P4A

DG	Sun1	21V	1.7	-	0.055	0.2	91	37 (-1,-5)	37	36	NPD/1B1	NPD/P2A
DG	Sun1	21Y	1.7	1.6	0.055	0.2	91	39 (-2,-5)	39	37	NPD/1B1	NPD/P2A
DG	Sun1	21Z	-	1.8	0.061	0.2	90	38 (0,-4)	38	37	NPD/1B1	NPD/P2A
DG	Sun1	23V	1.7	-	0.055	NPD	91	38 (-1,-5)	38	37	NPD/1B1	NPD/P4A
DG	Sun1	23Y	1.7	1.6	0.055	NPD	91	39 (-2,-5)	39	38	NPD/1B1	NPD/P4A
DG	Sun1	23Z	-	1.8	0.061	NPD	90	38 (0,-4)	38	38	NPD/1B1	NPD/P4A

TG	LowE	30V	1.2	-	0.075	0.3	95	45 (-2,-4)	45	31	NPD/1C1/1B1	NPD/NPD/P2A
TG	LowE	30Y	1.2	1.1	0.075	0.3	95	45 (-1,-4)	45	31	NPD/1C1/1B1	NPD/NPD/P2A
TG	LowE	30Z	-	1.2	0.091	0.3	94	44 (-1,-3)	44	32	NPD/1C1/1B1	NPD/NPD/P2A
TG	LowE	32V	1.2	-	0.075	NPD	95	45 (-2,-4)	45	32	NPD/1C1/1B1	NPD/NPD/P4A
TG	LowE	32Y	1.2	1.1	0.075	NPD	95	45 (-1,-4)	45	33	NPD/1C1/1B1	NPD/NPD/P4A
TG	LowE	32Z	-	1.2	0.091	NPD	94	44 (-1,-3)	44	33	NPD/1C1/1B1	NPD/NPD/P4A

TG	Sun1	31V	1.2	-	0.075	0.1	90	45 (-2,-4)	45	38	NPD/1C1/1B1	NPD/NPD/P2A
TG	Sun1	31Y	1.2	1.1	0.075	0.1	89	45 (-1,-4)	45	38	NPD/1C1/1B1	NPD/NPD/P2A
TG	Sun1	31Z	-	1.2	0.091	0.1	89	44 (-1,-3)	44	39	NPD/1C1/1B1	NPD/NPD/P2A
TG	Sun1	33V	1.2	-	0.075	NPD	90	45 (-2,-4)	45	39	NPD/1C1/1B1	NPD/NPD/P4A
TG	Sun1	33Y	1.2	1.1	0.075	NPD	90	45 (-1,-4)	45	39	NPD/1C1/1B1	NPD/NPD/P4A
TG	Sun1	33Z	-	1.2	0.091	NPD	90	44 (-1,-3)	44	39	NPD/1C1/1B1	NPD/NPD/P4A

WG	LowE	25V	2.0	-	0.069	NPD	94	36(-1,-4)	NPD	55	1B1/1B1	NPD/P2A
WG	LowE	25Y	2.0	-	0.069	NPD	94	36(-1,-4)	NPD	53	1B1/1B1	NPD/P2A
WG	LowE	25Z	2.0	-	0.069	NPD	93	36(-1,-4)	NPD	52	1B1/1B1	NPD/P2A
WAG	LowE	26V	2.0	-	0.069	NPD	NPD	36(-1,-4)	NPD	NPD	1B1/1B1	NPD/P2A
WAG	LowE	26Y	2.0	-	0.069	NPD	NPD	36(-1,-4)	NPD	NPD	1B1/1B1	NPD/P2A
WAG	LowE	26Z	2.0	-	0.069	NPD	NPD	36(-1,-4)	NPD	NPD	1B1/1B1	NPD/P2A

DG	LowE	20V	1.7	-	0.055	0.4	97	37 (-1,-5)	37	24	NPD/1B1	NPD/P2A
----	------	-----	-----	---	-------	-----	----	------------	----	----	---------	---------

The glazing unit has a black silk screen print along the edge  
 NPD = No Performance Determined

\* Slope α = 90°  
 \*\* Upstand height = 150 mm, if height > 150 – 600 mm, NPD  
 \*\*\* Only for glazing

# Classifications

Because the products are prefabricated, they can be tested extensively against all conceivable hazards and stressful events. Monolight and Linearlight roof windows are tested and CE marked in accordance with the harmonized standard EN 14351-1 Windows and doors.

Further, products can be tested for other commonly-used parameters customers may require.

All products are manufactured, assembled and delivered from the same heavily-controlled production line, leading to components with identical properties.

## Performance

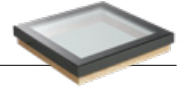

Essential characteristic performances according to EN 14351-1			
Test results	Monolight	Linearlight	Monolight Walk-on
Resistance to windload, EN12210, EN12211	Class C5 *	Class C3 *	Class C5 *
Watertightness, non shielded, EN12208, EN1027	Class E1200 **	Class E1200 **	Class E1200 **
Impact resistance, EN13049	Class 4	Class 4	NPD
Thermal transmittance, EN ISO 10077-1, EN ISO 10077-2	Depending on size and pane variant***	Depending on size and pane variant***	Depending on size and glazing variant***
Air permeability, EN12207, EN1026	Class 4 **	Class 4 **	Class 4 **
Reaction to fire, EN13501-1	Class B, s1-d0	Class B, s1-d0	Class B, s1-d0
Acoustic performance, EN ISO 140-3, EN ISO 717-1	34 (-1;-4) – 35 (-1; -3) dB ****	34 (-1;-4) – 35 (-1; -3) dB ****	36 (-1;-4) dB

\* For Monolight exceeding = 1170 mm (B) x 1170 mm (A): NPD, For Linearlight exceeding = 600 mm (B) x 1350 mm (A): NPD

\*\* For Monolight exceeding 2m<sup>2</sup>: NPD, For Linearlight exceeding 1.44m<sup>2</sup>: NPD

\*\*\* For further information, see page 35 in regard to U<sub>w</sub> according to EN 14351-1

\*\*\*\* Depending on size and pane variant. Burglary-resistant modules: 34 (-1; -4) – 36 (0; -3) dB. Contact VELUX Commercial for further information.

NPD = No Performance Determined

Additional performances for burglary-resistant variant			
Test results	Monolight	Linearlight	Monolight Walk-on
Burglary resistance, NEN 5096:2012+A1:2015, EN 1627:2011	Class 2 (RC2)*	Class 2 (RC2)**	NPD

\* = NPD for Monolight Venting width > 3.09 m

\*\* = NPD for Linearlight Venting

NPD = No Performance Determined

## U-values with outer surface area

Double Glazing = DG Triple Glazing = TG	Insulation Glazing Code	Clear internal area	U <sub>g</sub> [W/m <sup>2</sup> K] (Slope α = 90°, vertical)	U <sub>t</sub> [W/m <sup>2</sup> K] (Slope α = 0°, horizontal)	U <sub>RC,300</sub> [W/m <sup>2</sup> K] (Slope α = 0°, horizontal, upstand height 300 mm)	A <sub>RC,300</sub> [m <sup>2</sup> ] (developed area)
DG*	20V	a ≤ 2 m <sup>2</sup>	1.1	1.7	1.0	4.49
	20Y	2 m <sup>2</sup> < a ≤ 2.3 m <sup>2</sup>	1.1	1.7	1.0	4.49
	20Y	2.3 m <sup>2</sup> < a ≤ 2.8 m <sup>2</sup>	1.1	1.7	-	-
	20Z	2.8 m <sup>2</sup> < a ≤ 4.0 m <sup>2</sup>	1.1	1.8	-	-
TG*	30V	a ≤ 2 m <sup>2</sup>	0.5	0.8	0.71	4.49
	30Y	2 m <sup>2</sup> < a ≤ 2.3 m <sup>2</sup>	0.5	0.9	0.71	4.49
	30Y	2.3 m <sup>2</sup> < a ≤ 2.8 m <sup>2</sup>	0.5	0.9	-	-
	30Z	2.8 m <sup>2</sup> < a ≤ 4.0 m <sup>2</sup>	0.5	0.9	-	-
DG**	20V	a ≤ 2 m <sup>2</sup>	1.1	1.7	0.97	3.84
	20Y	2 m <sup>2</sup> < a ≤ 2.8 m <sup>2</sup>	1.1	1.7	1.1	3.84
	20Z	2.8 m <sup>2</sup> < a ≤ 4.0 m <sup>2</sup>	1.1	1.8	1.1	3.84
TG**	30V	a ≤ 2 m <sup>2</sup>	0.5	0.8	0.69	3.99
	30Y	2 m <sup>2</sup> < a ≤ 2.8 m <sup>2</sup>	0.5	0.9	0.74	3.99
	30Z	2.8 m <sup>2</sup> < a ≤ 4.0 m <sup>2</sup>	0.5	0.9	0.75	3.99

\* Calculated according to EN 1873 for reference size 1230 mm x 1400 mm (not part of CE marking)

\*\* Calculated according to EN 1873 for reference size 1200 mm x 1200 mm (not part of CE marking)

## Product tests

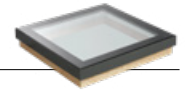

Watertightness



Air permeability



Resistance to wind load



Acoustic performance



Reaction to fire



Impact resistance

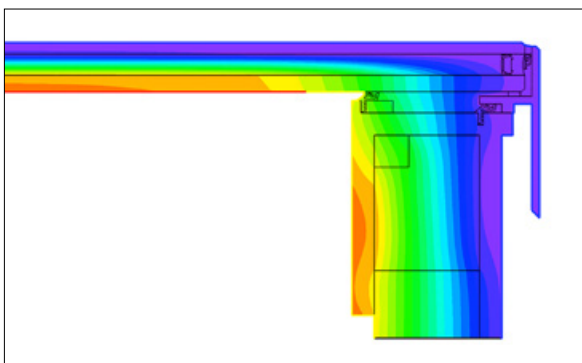

Thermal transmittance

# Data plate

## Information about the modules

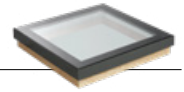

All VELUX Modular Rooflights, electrical components and accessory products have a data plate label. The data plate helps to identify the product and must NOT be removed.

If a product is damaged or malfunctioning, the information on the data plate must be given to the VELUX sales company.

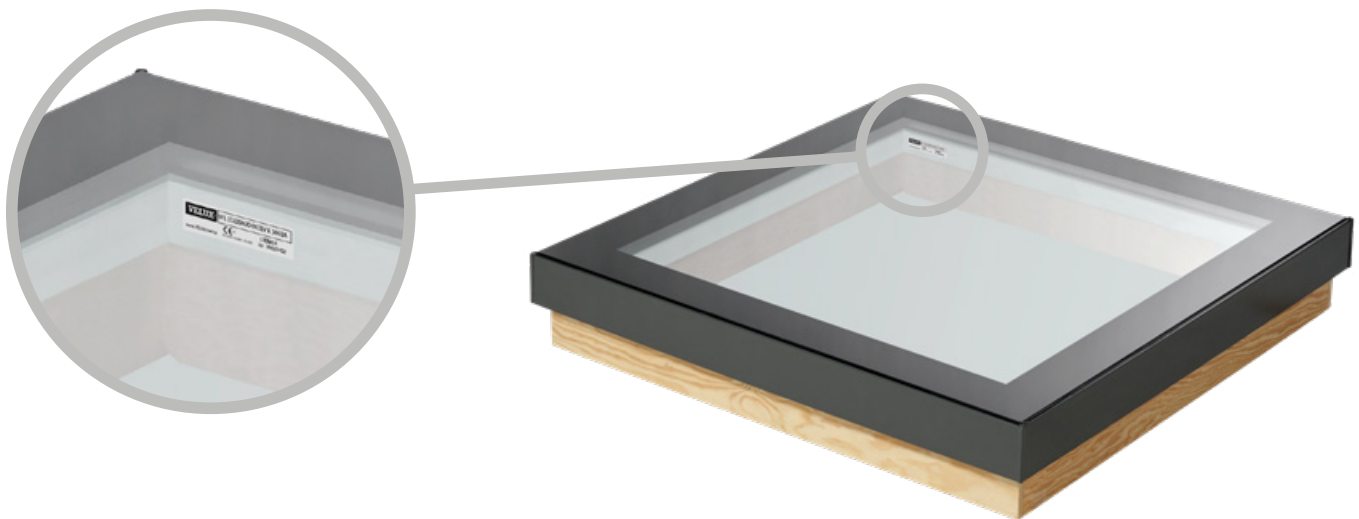
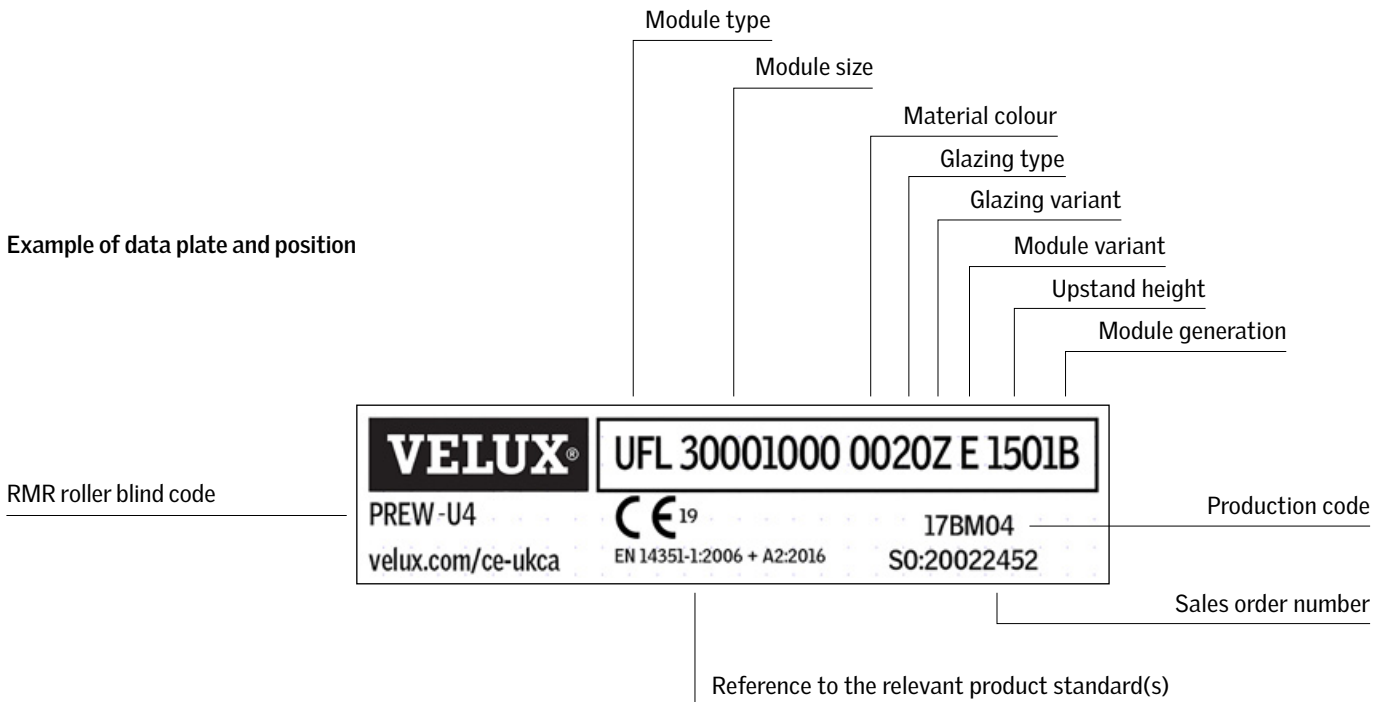

## Modular Rooflights – code structure

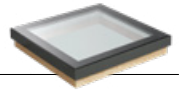

Example

UFL	30001000	0	0	20	Z	E	150	1	B
Type	Module width	Interior colour	Exterior colour	Glazing type	Glazing variant	Module variant	Upstand height	Branding	Module generation
U = VELUX Modular Rooflights	Above is a size example in mm	0 = std.	0 = std.	20 = DG/LowE	V = $a \leq 2m^2$	Linearlight:	Above is a size example in mm	1 = VELUX	A = Launch 2019 (welded frame, Burglary-resistant, Walk-on and Circularlight)
	Width and length (if Rectangular)	Standard, RAL 9010 gloss 30	Standard, RAL 7043 gloss 30	21 = DG/Sun1	V = $a \leq 1m^2$ (for Walk-on)	S = Start	150-600 mm		
	Diameter (if Circularlight)			22 = DG/LowE P4A	V = $a \leq 1,43m^2$ (for Circularlight)	M = Mid			
F = Fixed				23 = DG/Sun1 P4A		E = End			
V = Venting				25 = DG/LowE Walk-on	Y = $2m^2 < a \leq 2.8m^2$	W = Walk-on			
				26 = DG/LowE Walk-on anti-slip	Y = $1m^2 < a \leq 1.5m^2$ (for Walk-on)	Q = Burglary			
M = Monolight		8 = Non standard	5 = Standard, RAL 9005 gloss 30			QE = Burglary End			
L = Linearlight				30 = TG/LowE	Z = $2.8m^2 < a \leq 4m^2$	QM = Burglary Mid			B = Launch 2021 (corner keys & sandwich upstand)
C = Circularlight				31 = TG/Sun1	Z = $2.8m^2 < a \leq 3m^2$ (for Vented TG)	Burglary-resistant ONLY available with glazing type 22,23,32,33			
				32 = TG/LowE P4A	Z = $1.5m^2 < a \leq 2m^2$ (for Walk-on)				
			8 = Non standard	33 = TG/Sun1 P4A					
						X = Non standard			
				99 = Non standard					
						No letter for Monolight and Circularlight			

## Roller blind RMR codes



Example

Code	Explanation
NW / no code	Non wired
PREW-U1	Pre-wired left hand side
PREW-U3	Pre-wired right hand side
PREW-U4	Pre-wired top side
RMR-U1	Mounted RMR left hand side
RMR-U3	Mounted RMR right hand side
RMR-U4	Mounted RMR top side

# Venting module

## Chain actuator



In venting modules, the actuator is fully integrated in the timber upstand. The actuator is not visible from the inside when the module is closed, thus there is no visual difference between fixed and venting modules. The stroke length is 260 mm resulting in an opening of approximately 190 mm. The venting modules meet the requirements of the harmonised standard EN 60335-2-103(2015), see comment below for reference.

A venting module is operated by either one actuator or two synchronised actuators depending on the clear internal area and module width. For further information, see pages 23. The modules can be controlled by either a VELUX INTEGRA®, a Motorlink™ or Open System ± 24V (OS ±24 V DC) control system.

Monolight / Linearlight Venting Modules

Glazing - Double (DG) or Triple (TG)	DG	DG	TG	TG
Clear internal area – max.	2 m <sup>2</sup>	4 m <sup>2</sup>	1.5 m <sup>2</sup>	3 m <sup>2</sup>
No. of actuators* integrated in upstand	1	2	1	2

\* VELUX WMU 88V ---- (2 Amp/actuator)

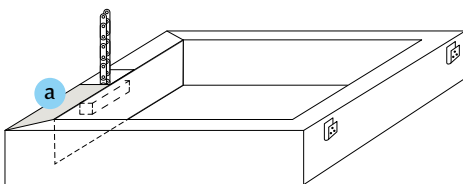

### Service Monolight venting and Linearlight venting

The actuator is accessible by removing the top plate (a)

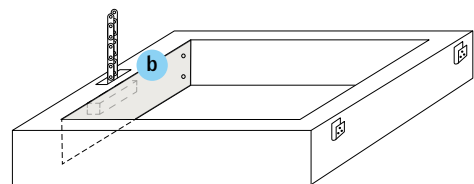

### Service Monolight Burglary-resistant venting

The serviceplate (b) must be accessible in connection with service of the chain actuator.



#### Global safety warning (except Germany, Austria, Switzerland)

Comfort venting VELUX Modular Rooflights meet the requirements of the harmonised standard EN 60335-2-103(2015) as to a max opening clearance of 200 mm (by means of physical limitation of the actuator) and as to the max closing speed of 15 mm/sec. Therefore, comfort venting rooflights can be installed within reach, i.e. at installation heights below 2.5 m above floor level (inside) and ground level (outside). According to EN 60335-2-103 access levels are defined as e.g. stairs and terraces. Surfaces not normally used for standing on, such as windowsills, and movable equipment such as ladders, are not considered to be access level.

Please note that the venting rooflights operate with high closing force, which can cause serious injury in case of entrapment. If VELUX roller blinds are installed in the rooflight, please observe recommendations in the safety instructions provided with each VELUX roller blind RMR.

We recommend that you observe national regulations and consider if the planned specific use of the building requires additional safety measures that must be applied by the installer/user to prevent serious injury.

The VELUX Group will not accept responsibility for damages, injury or death resulting from such an installation. The installer/user is ultimately responsible

for own omissions and actions. Measures could for instance be to install a motion sensor that is able to disconnect power from the control unit in case of any movement in the immediate vicinity of the VELUX Modular Rooflights.

#### Safety warning for Germany, Austria, Switzerland

VELUX Modular Rooflights have a recommended minimum installation height of 2.5 m above floor level (inside) and ground level (outside). In case of installation below that level, safety measures must be applied by the installer/user to prevent serious injury. No instruction or measure can eliminate the inherent hazards resulting from installation heights below 2.5 m.

If VELUX roller blinds are installed in the rooflight, please observe recommendations in the safety instructions provided with each VELUX roller blind RMR.

The VELUX Group will not accept responsibility for damages, injury or death resulting from such installation. The installer/user is ultimately responsible for own omissions and actions. Measures could for instance be to install a motion sensor that is able to disconnect power from the control unit in case of any movement in the immediate vicinity of the VELUX Modular Rooflights.



## Electrical system

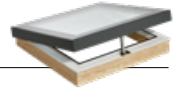

VELUX can supply two different electrical systems for controlling comfort venting modules, a VELUX INTEGRA® or a MotorLink™ system.

VELUX INTEGRA® is a wireless system for control of comfort venting and roller blinds and is based on io-homecontrol®. All components for VELUX INTEGRA® are supplied by the VELUX Group.

WMA MotorLink™ is a wired system for control of comfort venting modules. Basic components for a fully functional system can be supplied by the VELUX Group.

A third option is to use Open System, where the actuators are controlled by  $\pm 24$  V DC. In addition, the actuator can be integrated in common building automation fieldbus systems, e.g. KNX, BACnet, LON and Modbus, through the integrated MotorLink™ technology.

Connection to a fieldbus system requires a separate control box between fieldbus system and actuator. For the  $\pm 24$  V DC system, only the actuators are supplied by the VELUX Group.

As all three systems use the same actuator, the decision on which system to choose, can be postponed or changed at a later time. For small installations (e.g. few rooflights in the same area) a VELUX INTEGRA® or MotorLink™ will often be sufficient to cover all needs. Large installations (e.g. many different rooflights on different roofs) are likely to be integrated in a building management system and  $\pm 24$  V DC system should be considered.

In all cases the installed components must be accessible for service and maintenance.

### Planning the Electrical System:

- The control system is not a part of the VELUX Modular Rooflight venting modules, but can be purchased separately
- Wiring between the control system and the actuator is not part of the VELUX delivery
- The actuator can be controlled by either VELUX INTEGRA®, MotorLink™ or OS  $\pm 24$  V DC

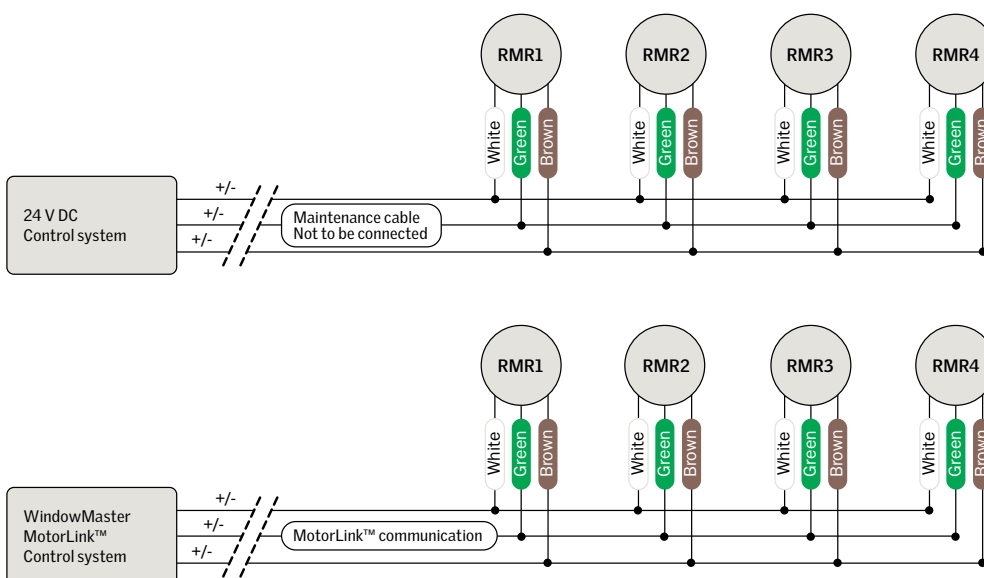

## Electrical components – VELUX INTEGRA® (standalone system)

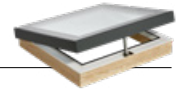

VELUX INTEGRA® is a wireless system for control of comfort venting modules. VELUX INTEGRA® is based on io-homecontrol®. When installing VELUX INTEGRA® products, you only need to install

standard 230V cabling to supply control unit KLC 410. All components for VELUX INTEGRA® are supplied by the VELUX Group.

Monolight / Linearlight Venting Modules				
Glazing - Double (DG) or Triple (TG)	DG	DG	TG	TG
Clear internal area – max.	2 m <sup>2</sup>	4 m <sup>2</sup>	1.5 m <sup>2</sup>	3 m <sup>2</sup>
No. of actuators* integrated in upstand	1	2	1	2

VELUX can provide following components for venting modules:

Control units				
KLC 410 – Power supply and control unit	1**	1**	1**	1**
Control switch and sensor				
KLR 200 – Control pad				
KLI 311 – Wall switch				
KLA 200 – Rain sensor				
KLF 200 – Interface (external control devices)				

\* VELUX WMU 88V (2 Amp/actuator)

\*\* No. of venting modules / control unit

To be decided according to the project requirement

Control pad	Power supply and control unit	Rain sensor
KLR 200	KLC 410	KLA 200

Wall switch	Wall switch	Interface (external control devices)
KLI 311 (for ventilation)	KLI 312 (for roller blinds)	KLF 200

## Electrical components – MotorLink™ (standalone system)

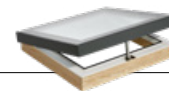

MotorLink™ system is a wired standalone system to control of comfort venting module. The actuator and the control box communicate through MotorLink™, which is a patented protocol from

WindowMaster. Basic components for a fully functional system can be supplied by the VELUX Group.

Monolight / Linearlight Venting Modules				
Glazing - Double (DG) or Triple (TG)	DG	DG	TG	TG
Clear internal area – max.	2 m <sup>2</sup>	4 m <sup>2</sup>	1.5 m <sup>2</sup>	3 m <sup>2</sup>
No. of actuators* integrated in upstand	1	2	1	2

VELUX can provide following components for venting modules:

Control units				
WCC 103 EU / WCC 103 UK (3 Amp)	1**	-	1**	-
WCC 310 S (10 Amp)	4**	2**	4**	2**
WCC 320 S (20 Amp)	8**	4**	8**	4**
Control switch and sensor				
WSK 102 (Fuga) – Control switch				
WSK 103 (Fuga) – Control switch				
WLA 330 – Wind and rain sensor				
WLA 331 – Rain sensor				
NV SOLO® – Rain and wind sensor, outdoor and indoor temperature sensor				

\* VELUX WMU 88V (2 Amp/actuator)

\*\* No. of venting modules / control unit

To be decided according to the project requirement

Control unit	Control unit	Control switch	Rain and wind sensor	Remote control with sensors
				
WCC 103	WCC 310/320	WSK 102 WSK 103	WLA 330 WLA 331	NV SOLO®

# Roller blinds

## Sun screening



The internal roller blind RMR is designed for installation with VELUX Modular Rooflights. The blind protects against heat and glare and helps to control the amount of light in the building. The roller blind is available in any height from 725 mm till 3000 mm and in width from 600 mm till 1000 mm. It can be oriented in the top-bottom or side-side direction of the rooflight.

The roller blind is available for Monolight and Linearlight both fixed and venting, including burglary-resistant modules. To support fast and safe installation of VELUX Modular Rooflights, it is possible to order roller blinds with hidden pre-wiring and completely pre-mounted from the factory, except for burglary-resistant modules.

The blind consists of four wheels, one in each corner of the rooflight upstand and two steel wires at the side of the blind. The two wires pull a lightweight polyester fabric available in three commonly used colours.

VELUX roller blinds are electrically operated and can be controlled using either VELUX INTEGRA® or Open System ±24V (OS ±24V DC).

### Operation

One power supply and control unit KLC 410 per four roller blinds RMR is required. Roller blinds RMR can be operated from either one of the following or a combination of:

- Control pad KLR 200 – individual or simultaneous operation
- Wall switch KLI 312 – simultaneous operation

### Order the right size

To order the right sizes see the data plate on the VELUX Modular Rooflight. How to read the data plate, see page 38.

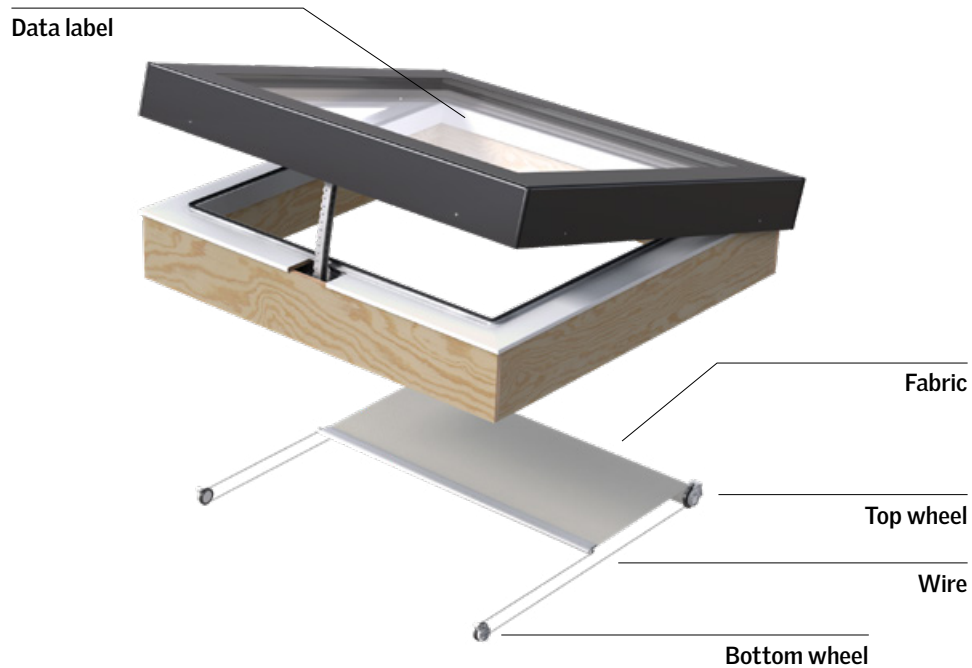

VELUX can provide following components for roller blinds RMR: (see page 42 for reference)

Control units	
KLC 410 – Power supply and control unit	4*
Control switch	
KLR 200 – Control pad	
KLI 312 - Wall switch	
KLF 200 – Interface (external control devices)	

\* No. of roller blinds / control unit

To be decided according to the project requirement

# Size overview of roller blinds



The table gives an indication of module size limits for all roller blinds variants.

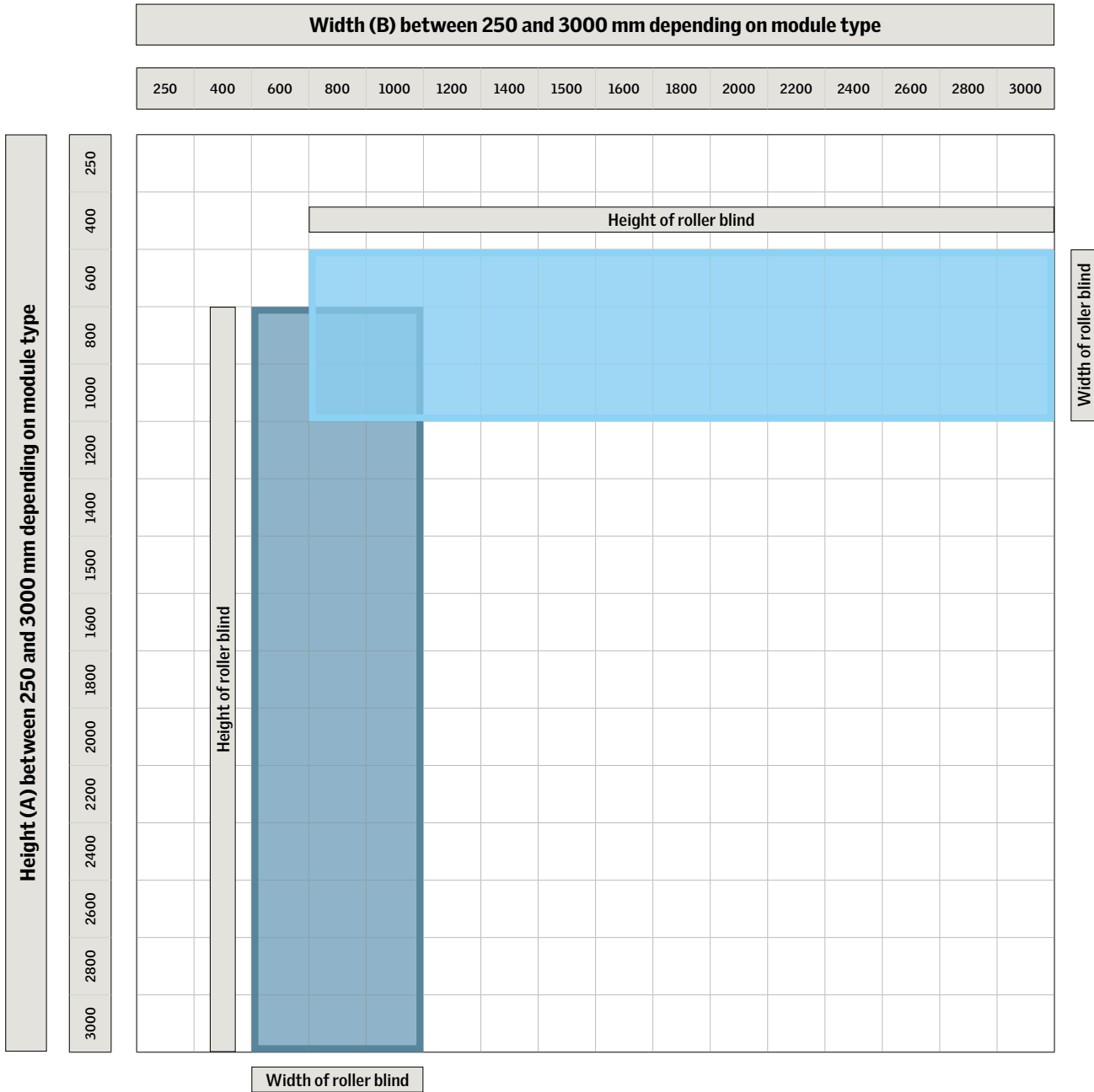

- Side-side direction**
- Top-bottom direction**



Linearlight with minimized beam and roller blinds



## Sun screening and colours



### Fire retardant sun screening

Fire retardant sun screening			
Colour: Variant code	Grey RMR 8805	White RMR 8806	Black RMR 8807



The blind cloth of VELUX roller blinds is pulled on two tension steel wires on pulley wheels, which are accessible, when the roller blinds are installed on rooflights within reach and therefore can cause serious injury, if a person gets in contact with this during the electrical operation of the blind. VELUX roller blinds have a recommended minimum installation height of 2.5 m above floor level (inside) and ground level (outside). In case of installation below that level, safety measures must be applied by the installer/user to prevent serious injury. No instruction or measure can eliminate the inherent hazards resulting from installation heights below 2.5 m.

We recommend you to observe national regulations and consider if the planned specific use of the building requires that additional safety measures must be applied by the installer/user to prevent serious injury.

The VELUX Group will not accept responsibility for damages, injury or death resulting from such installation. The installer/user is ultimately responsible for own omissions and actions. Measures could for instance be to install a motion sensor that is able to disconnect power from the control unit in case of any movement in the immediate vicinity of the VELUX Modular Rooflights.

## Interior design



The motor for roller blind operation is hidden inside the rod.



Roller blinds are kept tight and smooth by a strong, thin wire suspension.



Roller blind bottom wheel ensures position of the wire.



## Interior design



Roller blind RMR at top side of Linearlight.



Roller blind fixation at bottom side of Linearlight.

# Sectional Drawings

## Monolight

Examples of sectional drawings. The full assortment is available at our website.  
 Monolight fixed – double glazing  
 (Triple glazing also available)

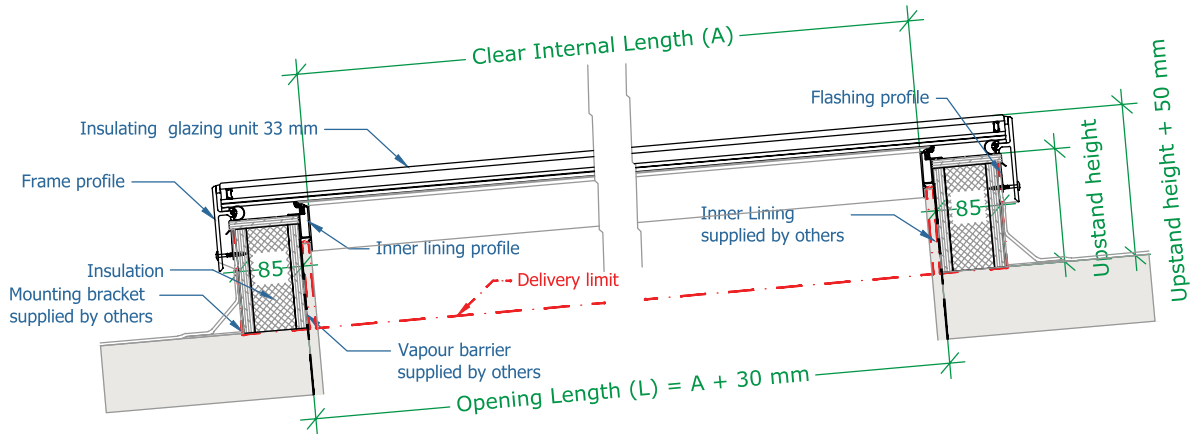

Cross-section – bottom

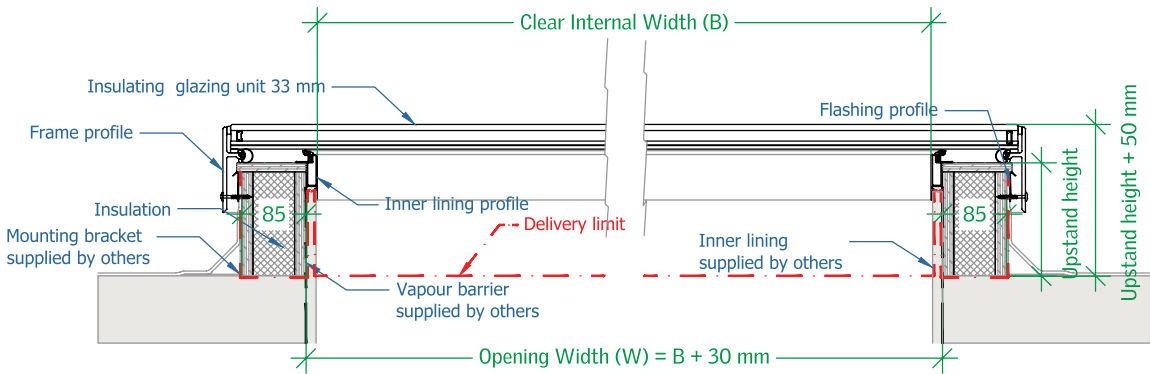

Longitudinal section

# Linearlight

Examples of sectional drawings. The full assortment is available at our website.  
 Linearlight fixed/venting – double glazing  
 (Triple glazing also available)

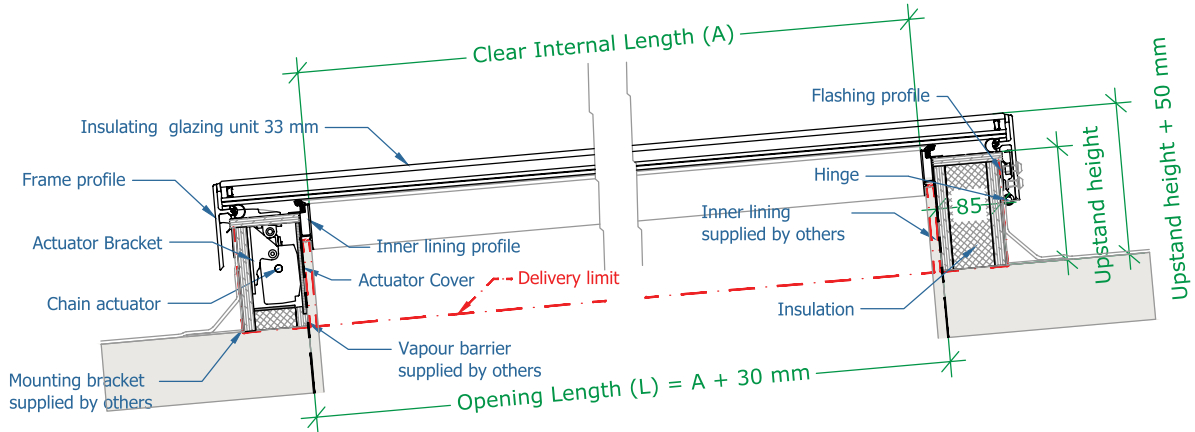

Cross-section – bottom

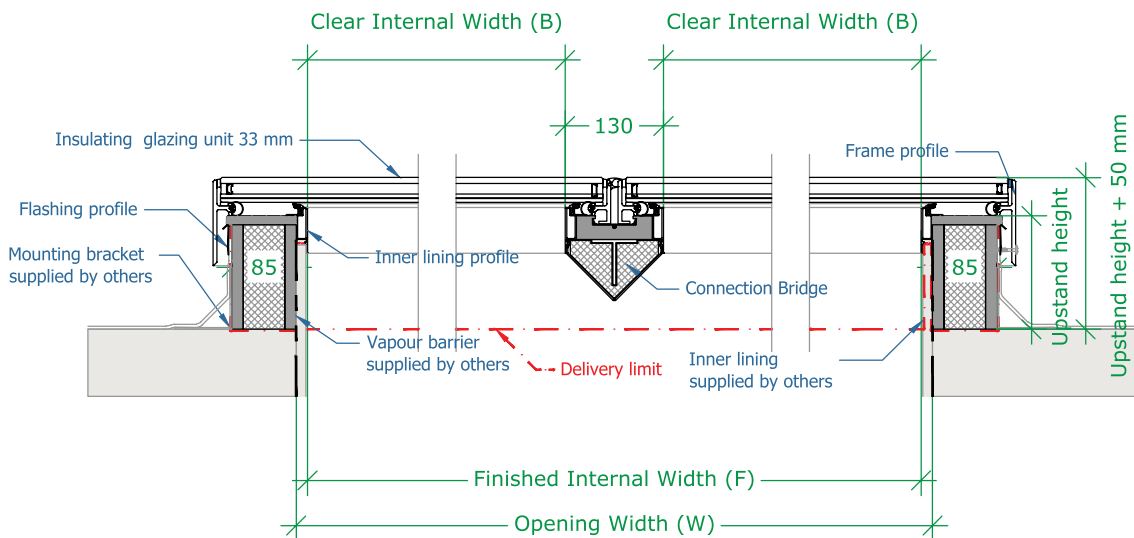

Longitudinal section

# Walk-on

Examples of sectional drawings. The full assortment is available at our website.  
Walk-on fixed – double glazing

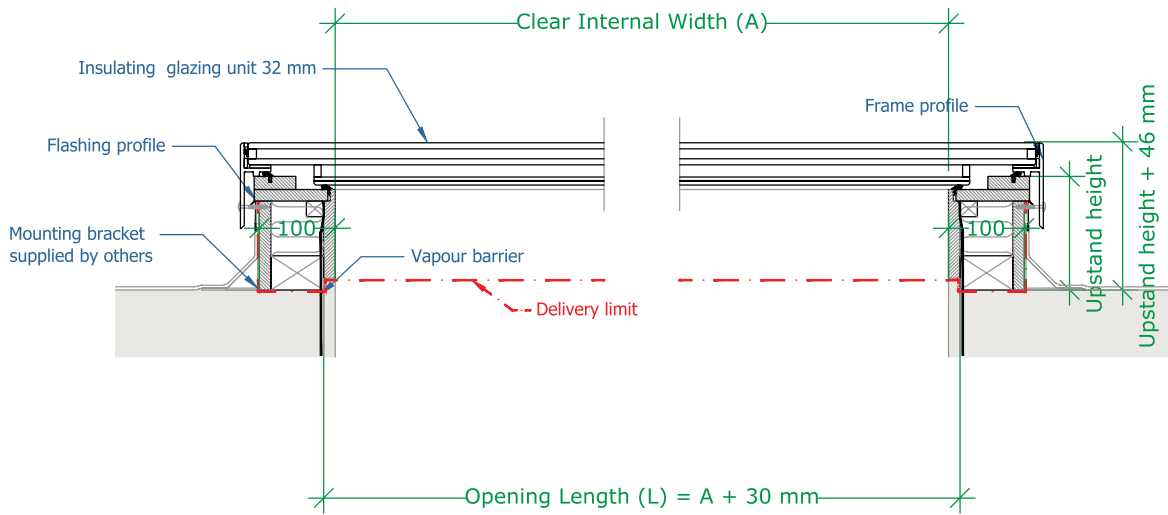

Cross-section - bottom

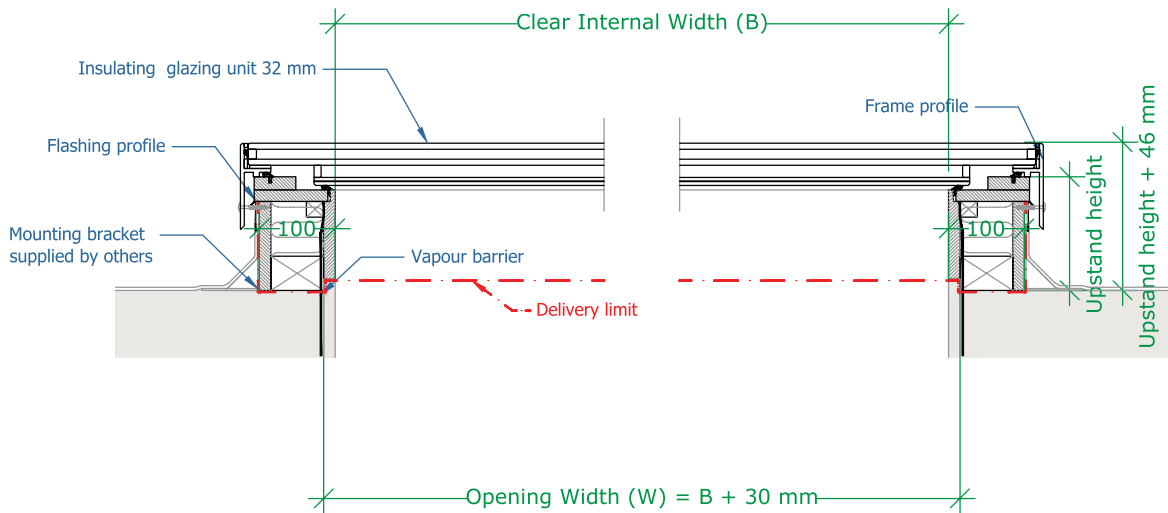

Longitudinal section

## Circularlight

Examples of sectional drawings. The full assortment is available at our website.  
Circularlight fixed – double glazing

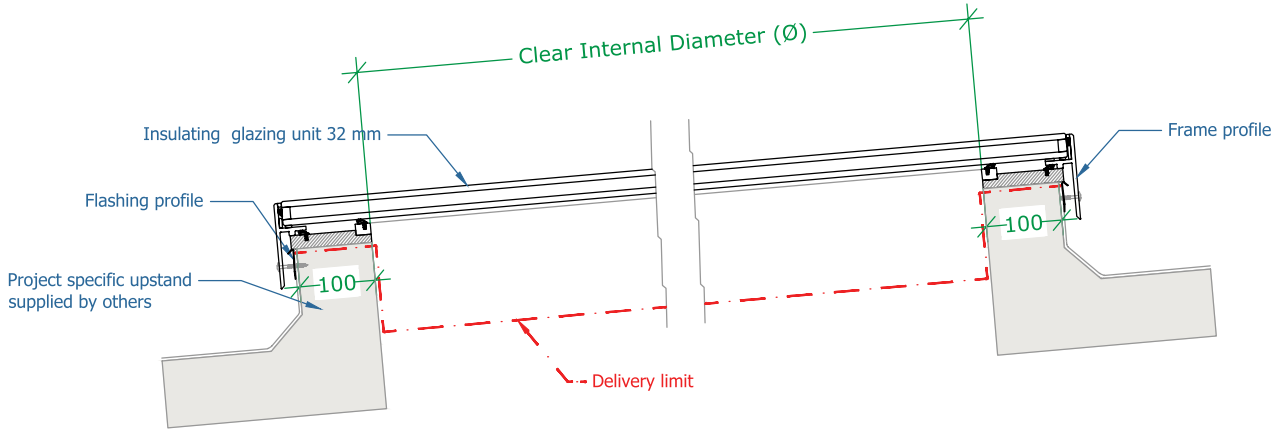

Cross-section – bottom

## Burglary-resistant

Examples of sectional drawings. The full assortment is available at our website.  
Monolight burglary-resistant fixed – double glazing

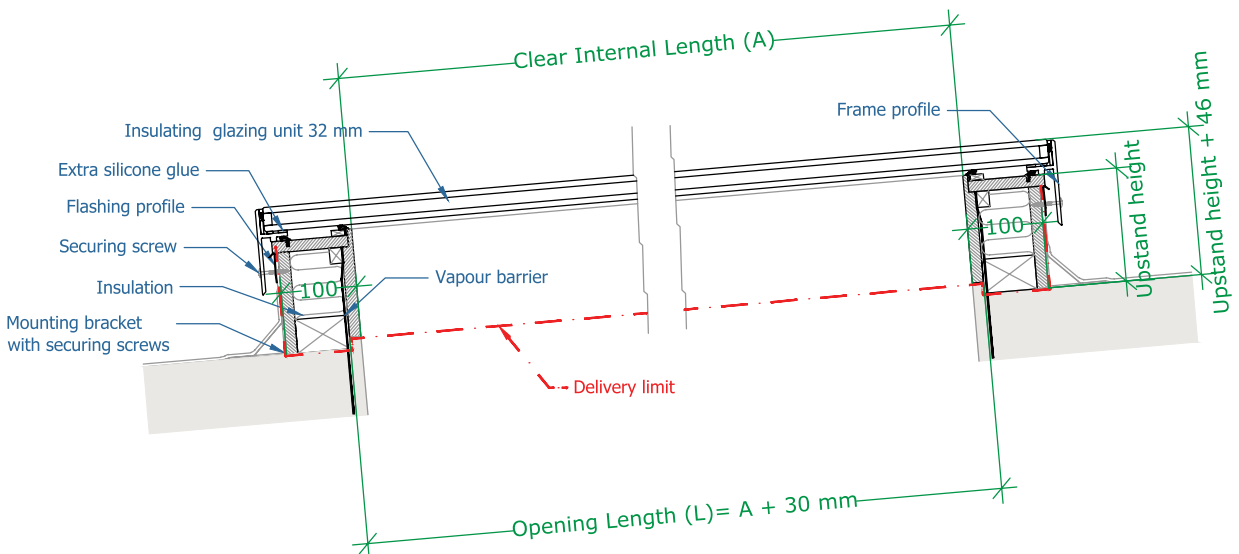

Cross-section – bottom

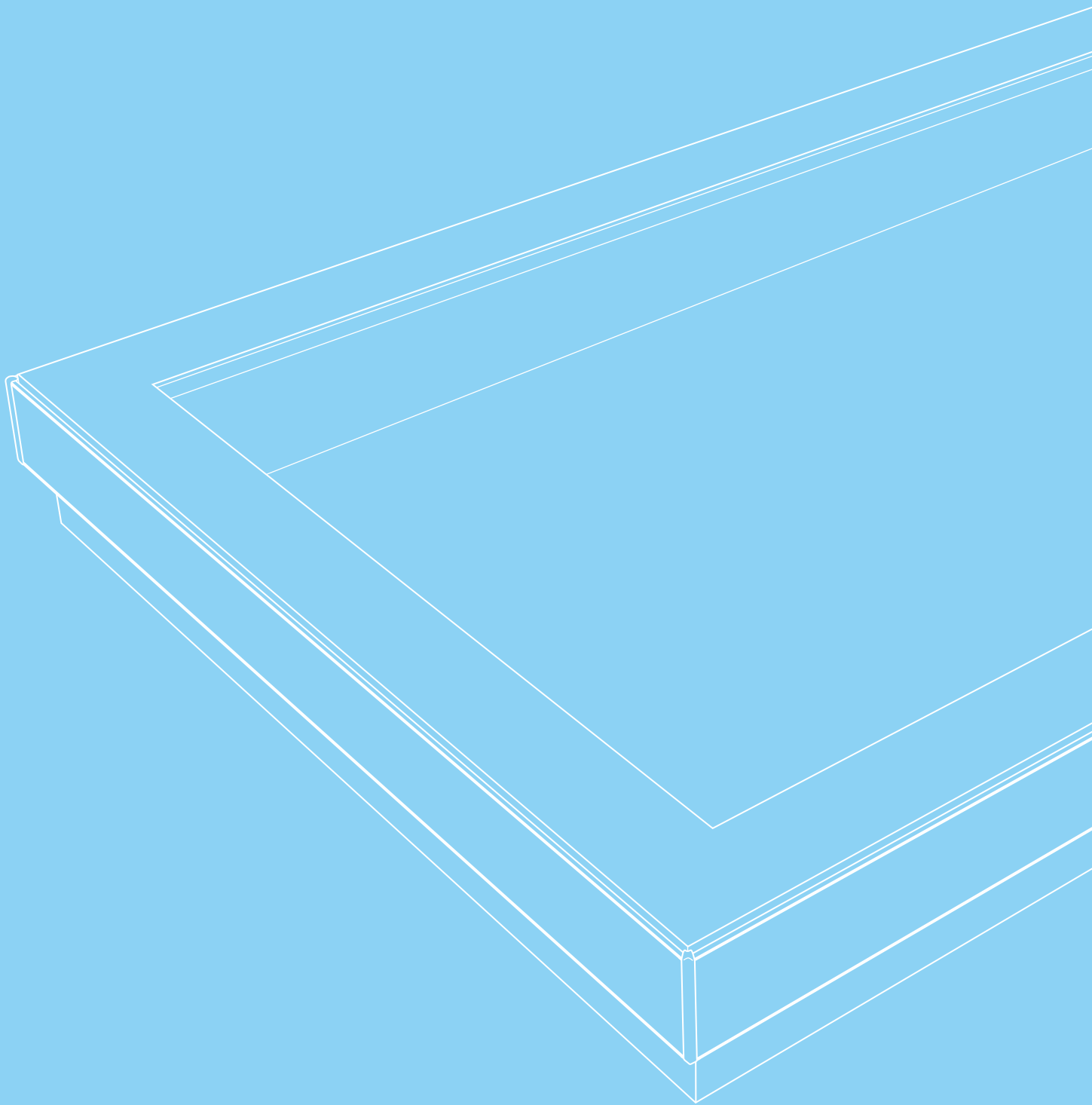

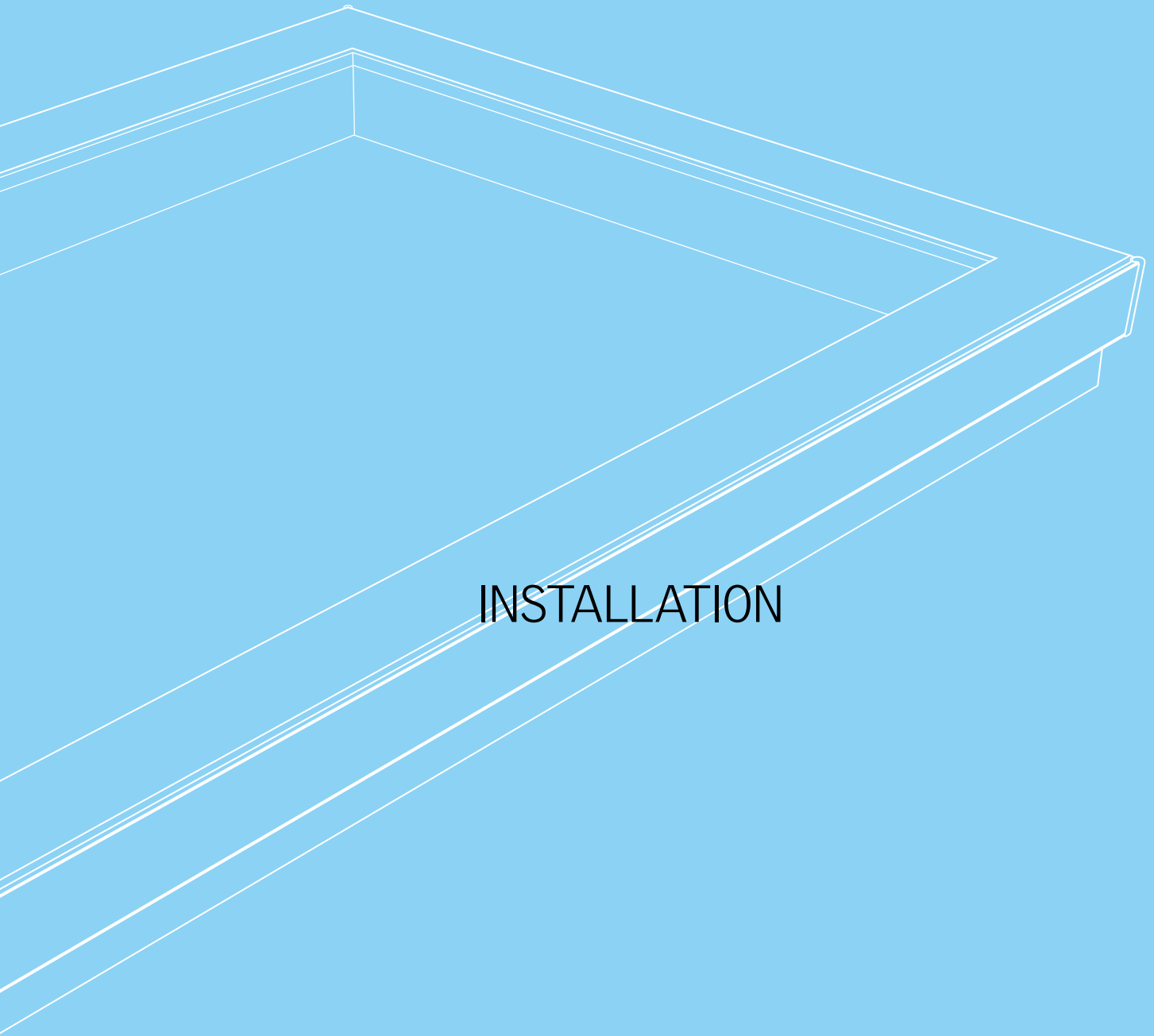

# INSTALLATION

# Designed for easy installation

All components are designed in accordance with the overall system. In our controlled facilities, we monitor all aspects of production to ensure a perfect fit and assembly. A strong integrated upstand ensures stability of the product, so that it can be installed on virtually any slightly inclined roof structure. This makes it possible to mount the upstand and top unit within minutes.

The VELUX Group does not take responsibility for the sub-construction.

## Installation of Monolight venting

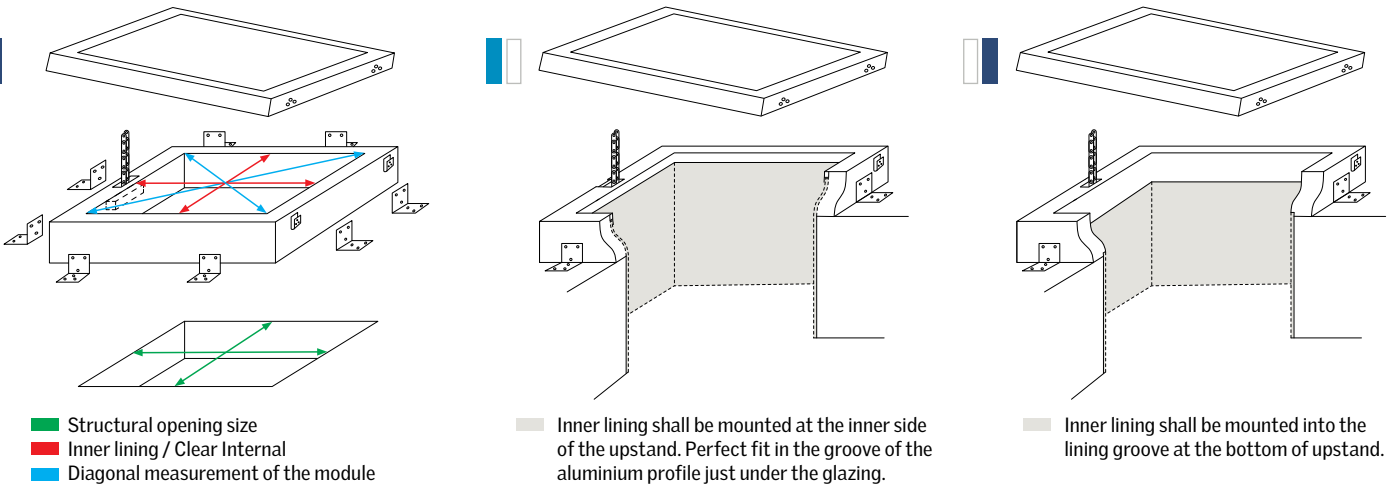

## Installation of Linearlight

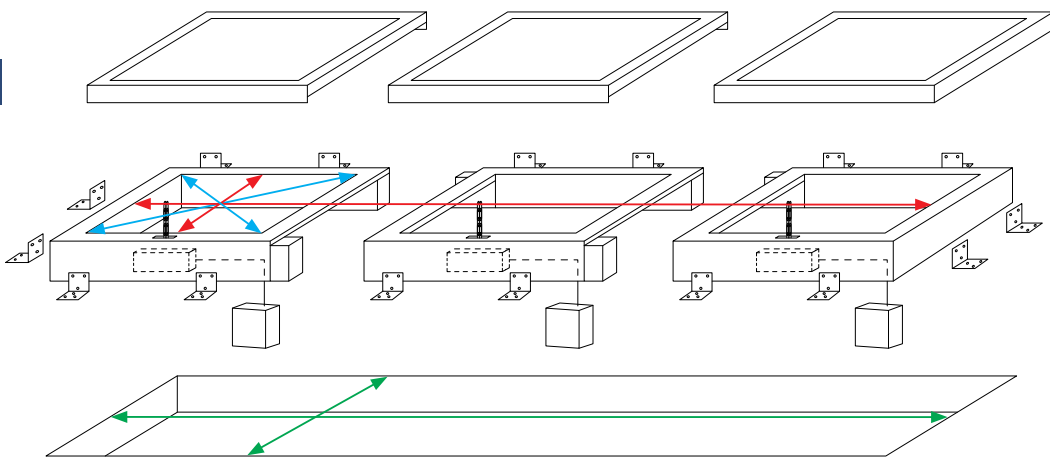

Read more about the installation in our installation instructions. Can be downloaded at your local VELUX Commercial website.



## A fast installation system



Craning products to the roof



Preparing the hole for the upstand



Securing the upstand and roofing material for watertightness without exposing the product to the flame.



Placing the top unit



Placing the top unit



External work finalized



Connecting the electricity and checking the functionality

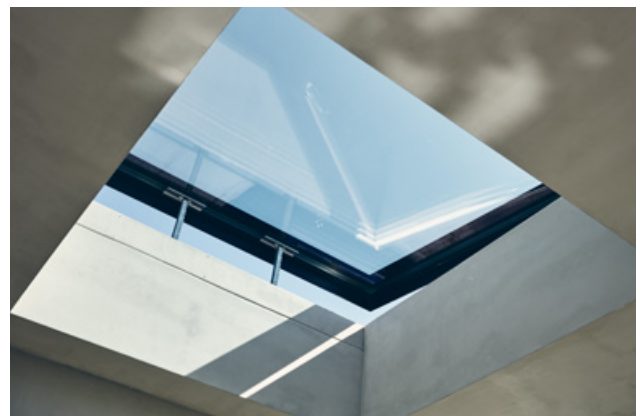

Internal work finalized

Note: Generation A is shown on above photos



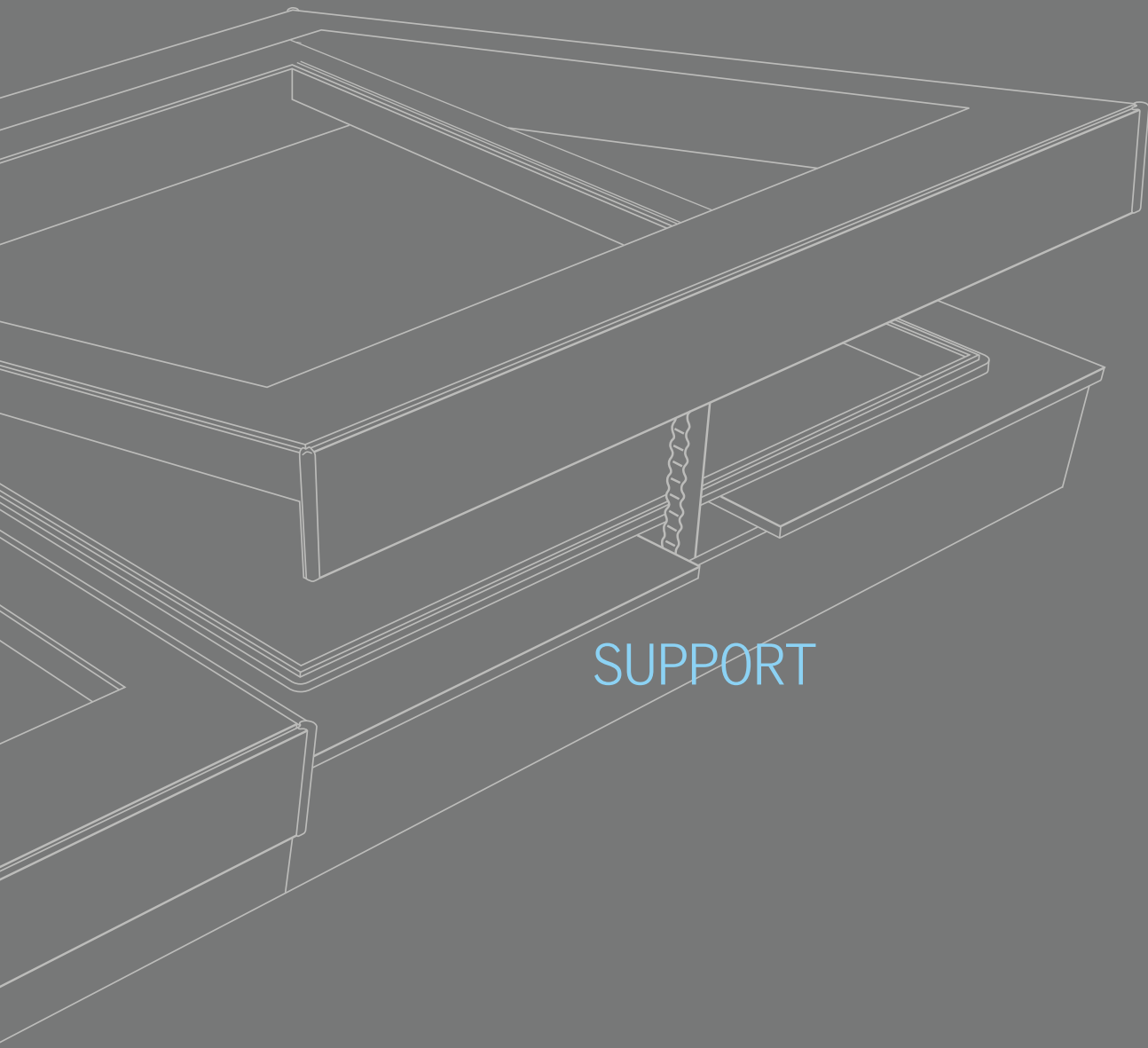

SUPPORT

## Technical drawings, 2D

### Download detailed 2D illustrations and technical drawings

Precise and detailed AutoCAD material can be downloaded for immediate use, directly from our website. The drawings contain all relevant descriptions and measurements.



Download a complete folder with all material on modular rooflights. The brochure and drawings are also available for download at your local VELUX Commercial website.

## CAD/BIM objects, 3D drawing tools

### Use drag and drop objects

VELUX CAD/BIM objects are available for use with the most popular modelling programs. Furthermore, all 3D objects are compatible with Autodesk AutoCAD and

Trimble SketchUp. The object families are built in accordance with buildingSMART, including: COBIE, CCS and Omni class.



Objects can be downloaded from BIMobject and from your local VELUX Commercial website.



[www.bimobjects.com](http://www.bimobjects.com)

## VELUX Daylight Visualizer

A professional tool for projects of all sizes

VELUX Daylight Visualizer is a professional simulation tool that offers precise and visually convincing daylight analysis of any given rooflight installation. The tool permits you to accurately simulate and quantify daylight levels in the interiors, develop before and after scenarios and create extensive data reports for project review. All projects can be imported or exported at will for further processing.

Comprehensive daylight planning is a prerequisite to achieving optimal daylight conditions in commercial buildings. Proper daylight management will always be an asset. For example, by replacing artificial light, you'll save electricity and by providing free solar heating, you'll save on conventional energy consumption.

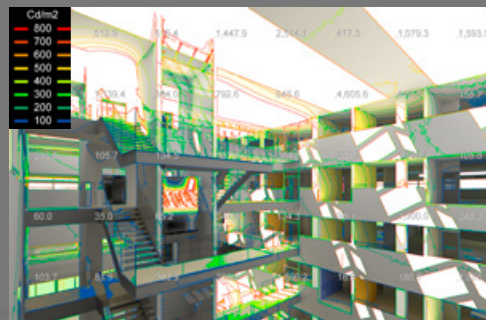
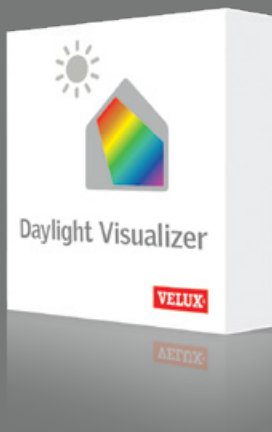

## Design your own grand ideas – Create a magnificent rooflight

Ready to know if your ideas can become a reality?

Let us calculate your possibilities and give a price estimate for your chosen solution.

Contact your local VELUX Commercial sales office for more details.

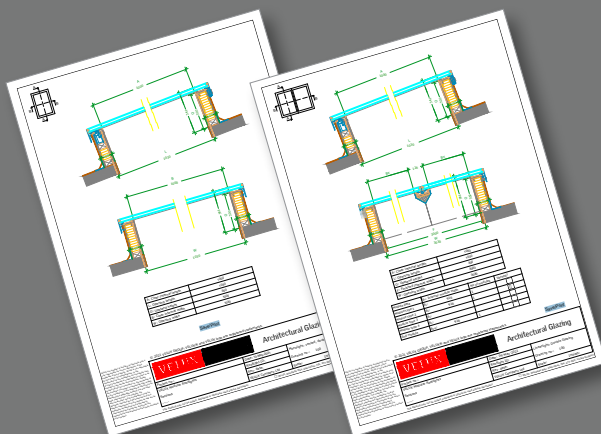

Sub-construction quality assurance (QA) document and specification documents

## Design phase



### Consultancy

To help you get started, we offer expert guidance even before your project gets approved.

### Technical documentation

All technical documents are available for download on our websites.

### Specification

Our experienced building consultants stand ready to help you specify your projects.

### Statics

The evaluation of the local load conditions, applying national methods and additional safety factors (if any) are solely your responsibility. VELUX does not assume any liability in this regard.

### Humid areas

In order to maintain guarantee, it is necessary to ensure adequate ventilation when installing the products in areas with high humidity such as in bathrooms. Please ask our consultants for more details.

## Installation phase



### On-site support

Once your project is underway, we will help you track your progress and offer on-site consulting on projects and critical issues.

### Instruction

To ensure high safety and efficiency on the construction site, we offer various forms of training for all installers involved. The training can take place directly on the construction site, where your project is being performed.

## Daily operation



### After sale

A number of tools and accessories are available to help optimise your solution, if or when the requirements evolve.

### User guidance

To maximise performance output, we are there to guide you on the different components of the solutions and we offer training.

### Product service

Should the system, for some reason, require professional service, our team of VELUX service technicians will do all they can to solve the problem to everyone's satisfaction.



## Guarantee



Our Modular Rooflights are supported by a 10-year guarantee. Blinds, actuators and other electrical components that are a part of the modular system come with a 3-year guarantee. The guarantee is subject to correct installation and usage.

Guarantee conditions can be found at your local VELUX Commercial website.

## Contact



Our aim is to provide all the tools and answers to make your project as simple and trouble-free as possible. Thus, we offer a wide range of expert support and

consulting from before the project starts to well after its completion. To get in touch, please contact your local VELUX Commercial sales office.

VELUX Svenska AB  
VELUX Commercial  
Karbingatan 22  
254 67 Helsingborg  
Sverige

Email: [vms.se@velux.se](mailto:vms.se@velux.se)  
Web: [veluxcommercial.se](http://veluxcommercial.se)  
Blog: [vms.velux.se](http://vms.velux.se)



# Din föredragna partner inom dagsljus- och ventilationslösningar

**VELUX®**

Commercial