

TECHNICAL INFORMATION

OCTANORM CLEANROOM SYSTEMS

PHARMACEUTICAL AND MEDICAL ENGINEERING

Wall systems with wall cladding

Technical data sheet

Wall system P90

Wall system P98

THE
WORLD
OF
SYSTEMS

OCTANORM 





TECHNICAL DATA SHEET

WALL TYPE P90

Wall system with suspended steel sheet lagging

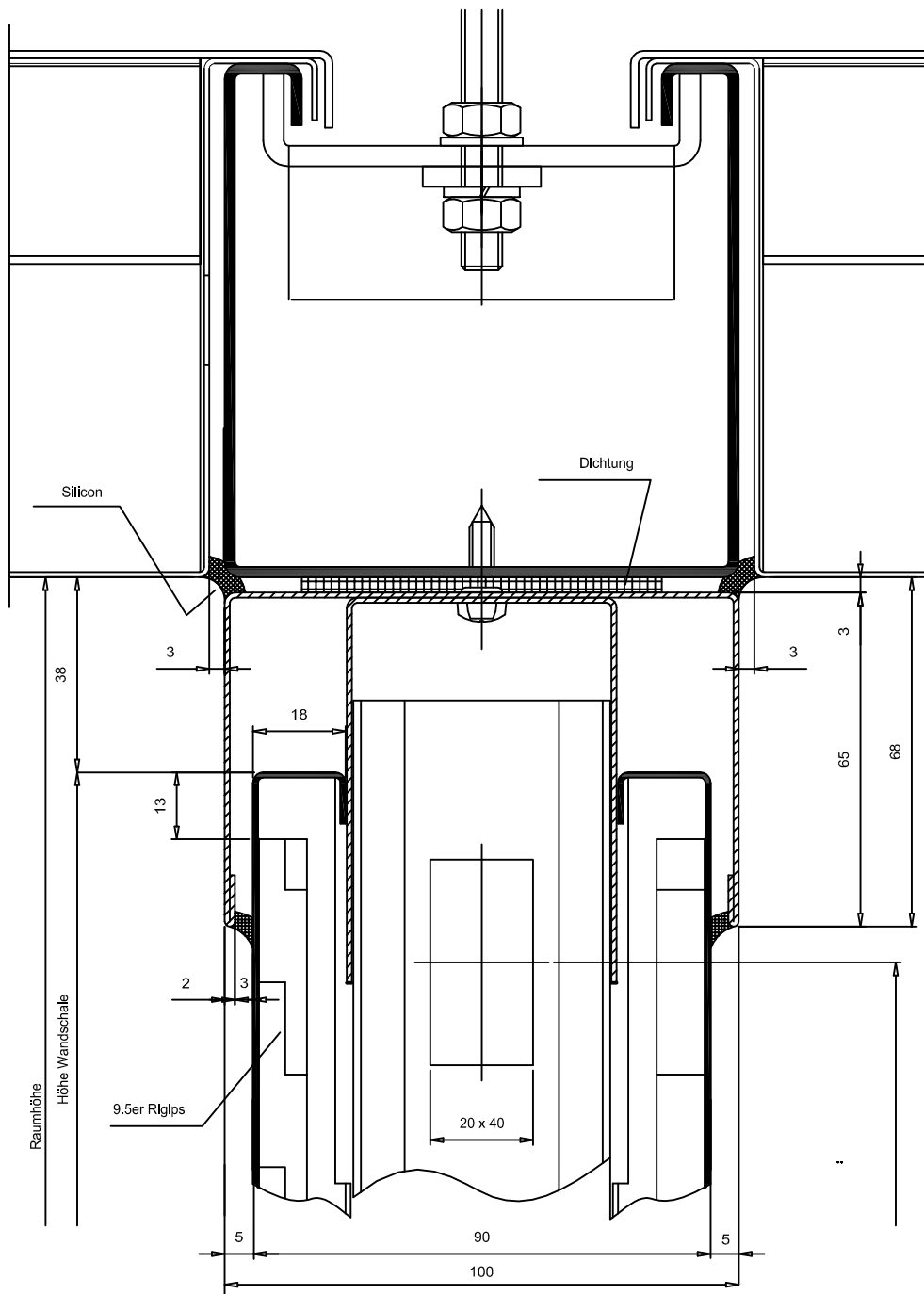
Surface of beam / extrusion	steel, blank
Surface of panels	Powder-coated or stainless steel, grinded
Panels	Steel sheet panel with plaster cardboard on the backside
Standard grid	1200 mm
Standard color	RAL 9010
Filling	none or on request
Wall height	2500 mm to 4500 mm, depends on grid size
Wall thickness	90 mm



Alle Toleranzen nach DIN ISO 2768 mittel				Material			
This drawing is our literary property and may neither copied nor to be exposed approachable to third persons without our agreement; according to German Copyright Act							
				Datum	Name	Description / Bezeichnung: D 005 Wand- Deckenanschluss an Bandraster	
				Gezeichnet	24.07.2014		jk
				Kontrolliert			
				Norm			
				Projekt Nr.		Z-Nr: VRS_P90_11_0001	
				PRO_XXX			
Status	Änderungen	Datum	Name			1 A4	

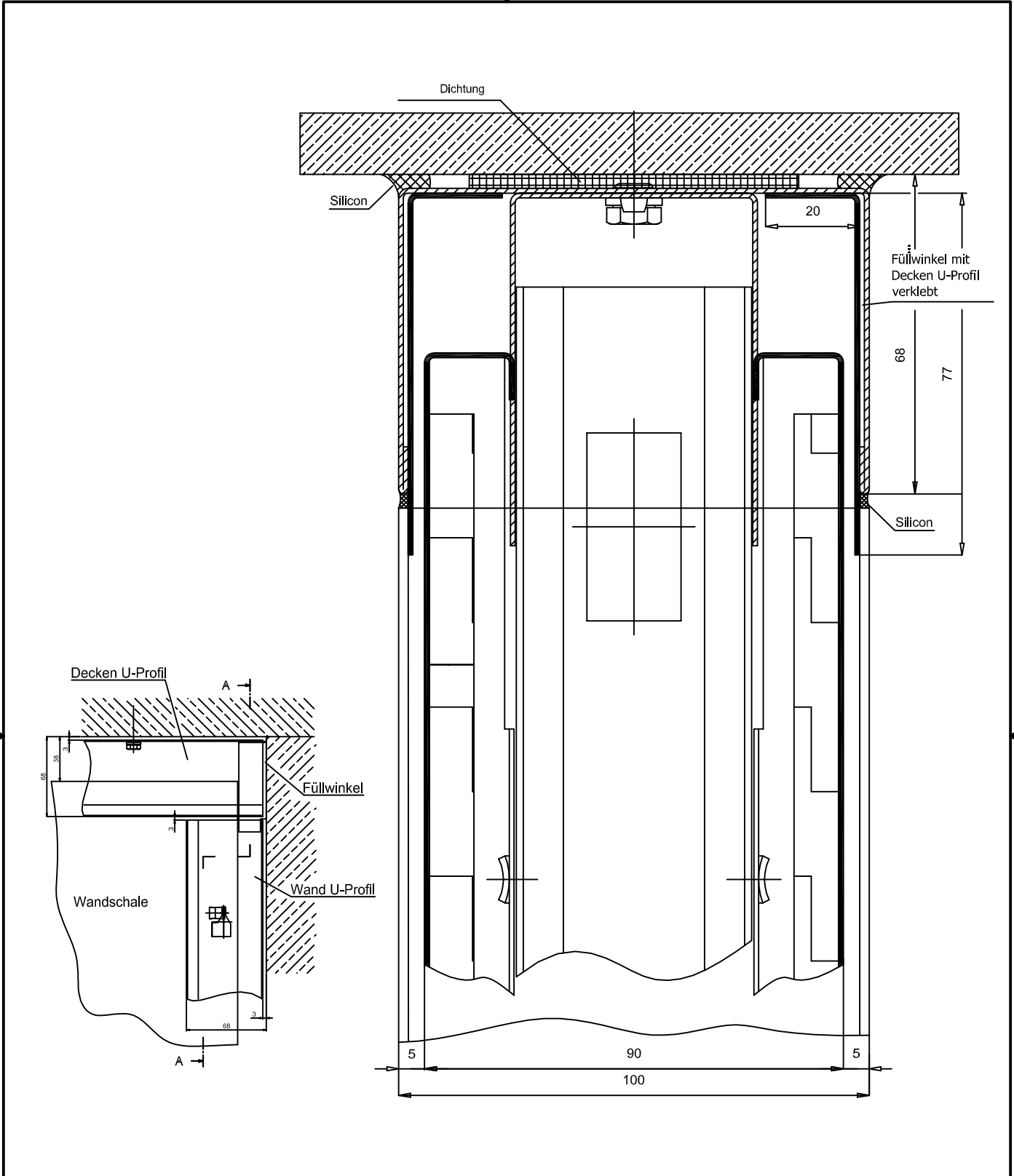

Alle Toleranzen nach DIN ISO 2768 mittel		Material		
This drawing is our literary property and may neither copied nor to be exposed approachable to third persons without our agreement; according to German Copyright Act				
		Datum	Name	Description / Bezeichnung: D 005 A Wand- Deckenanschluss Trennwand Voll
		Gezeichnet	24.07.2014 jk	
		Kontrolliert		
		Norm		
		Projekt Nr.		Z-Nr: VRS_P90_11_0002
		PRO_XXX		
Status	Änderungen	Datum	Name	1 A4

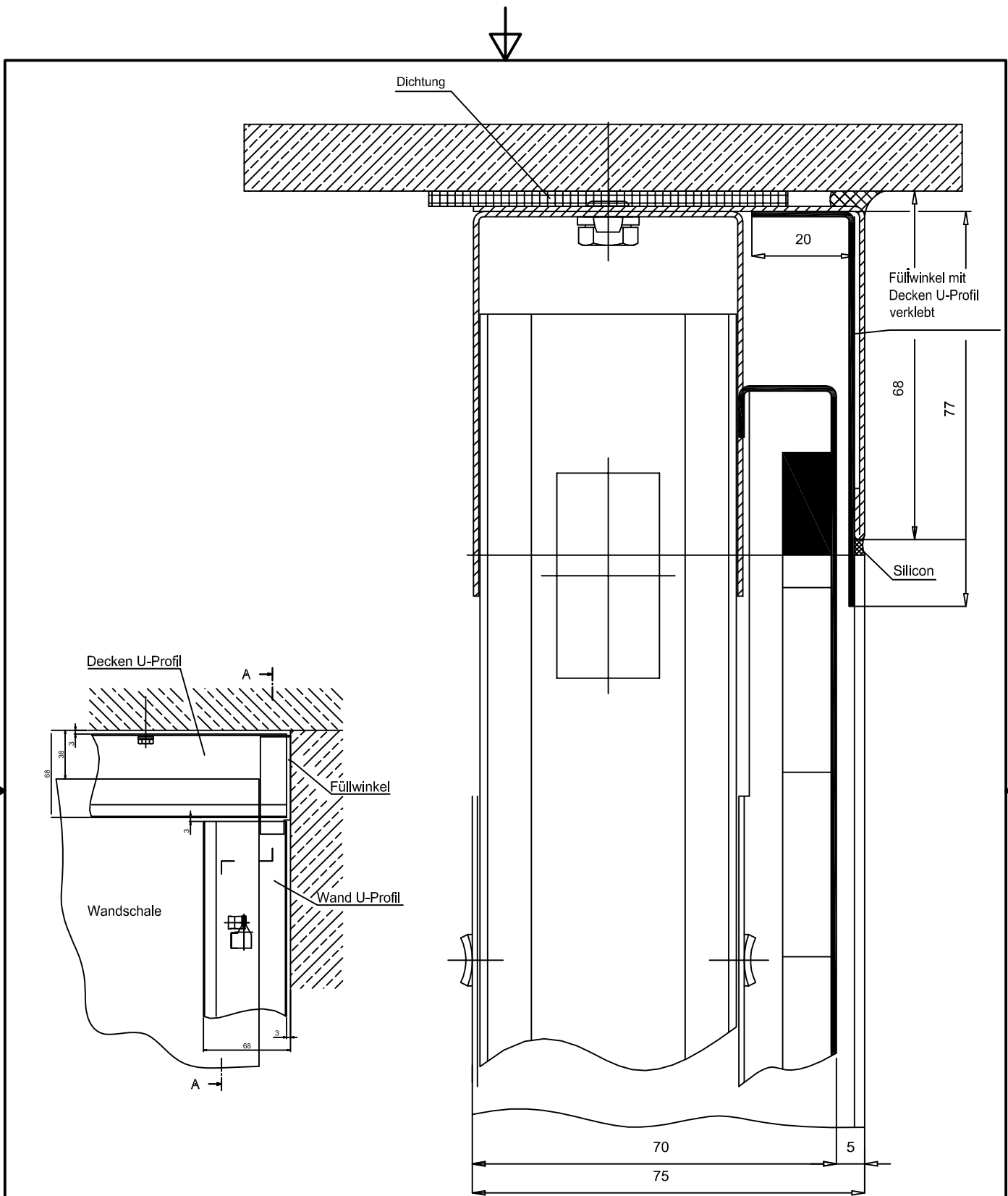

Alle Toleranzen nach DIN ISO 2768 mittel				Material			
This drawing is our literary property and may neither copied nor to be exposed approachable to third persons without our agreement; according to German Copyright Act							
			Datum	Name		Description / Bezeichnung: D 005 B Wand- Deckenanschluss Trennwand Wandschale	
			Gezeichnet	24.07.2014	jk		
			Kontrolliert				
			Norm				
			Projekt Nr.			Z-Nr: VRS_P90_11_0003	1
			PRO_XXX				
Status	Änderungen	Datum	Name			A4	

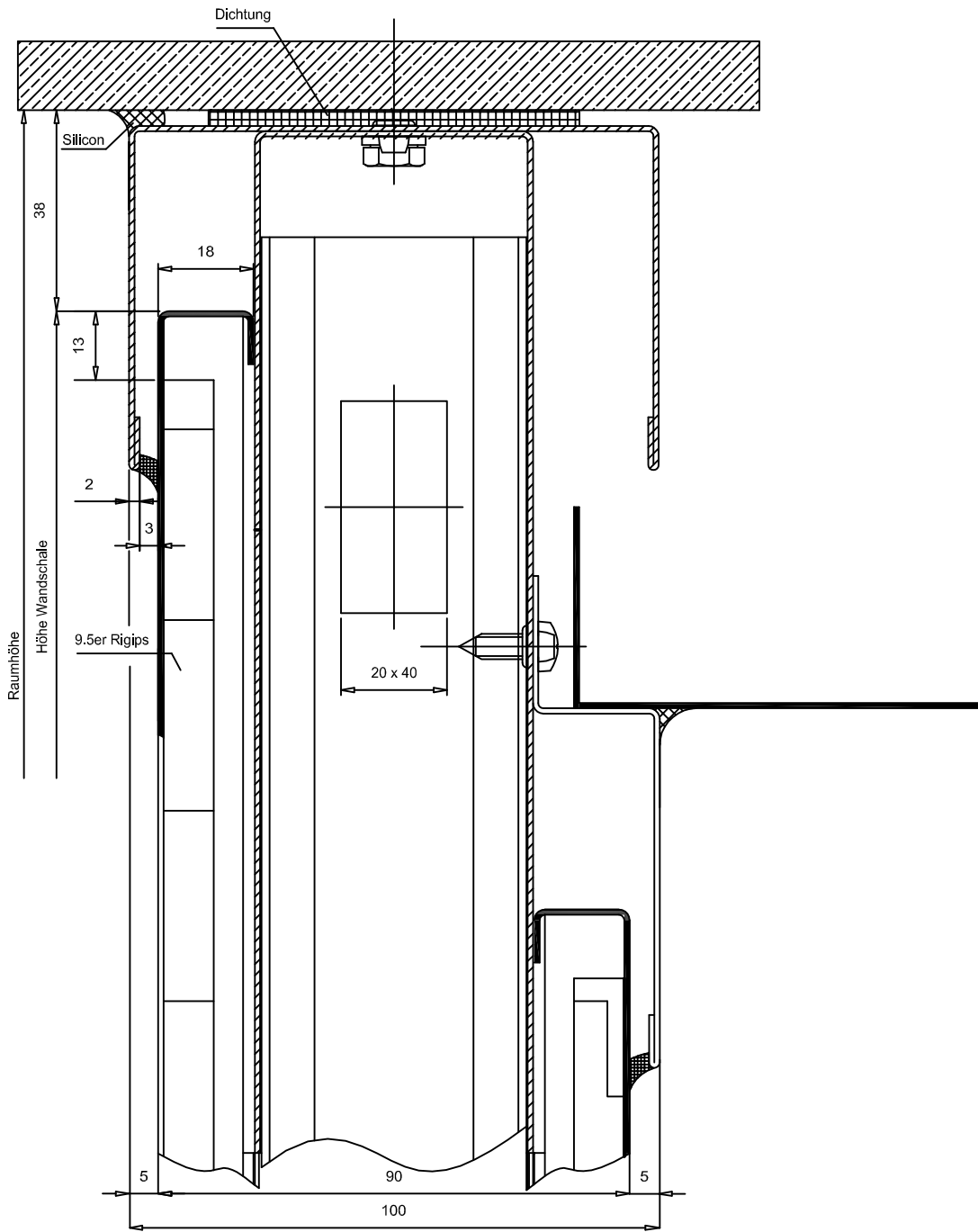

Alle Toleranzen nach DIN ISO 2768 mittel		Material		
<small>This drawing is our literary property and may neither copied nor to be exposed approachable to third persons without our agreement; according to German Copyright Act</small>				
		Datum	Name	Description / Bezeichnung: D 005 C Deckenanschluss mit Deckensprung
		Gezeichnet	24.07.2014 jk	
		Kontrolliert		
		Norm		
		Projekt Nr.		Z-Nr: VRS_P90_11_0004
		PRO_XXX		
Status	Änderungen	Datum	Name	<div style="text-align: right; font-size: 24pt; font-weight: bold;">1</div> <div style="text-align: right;">A4</div>

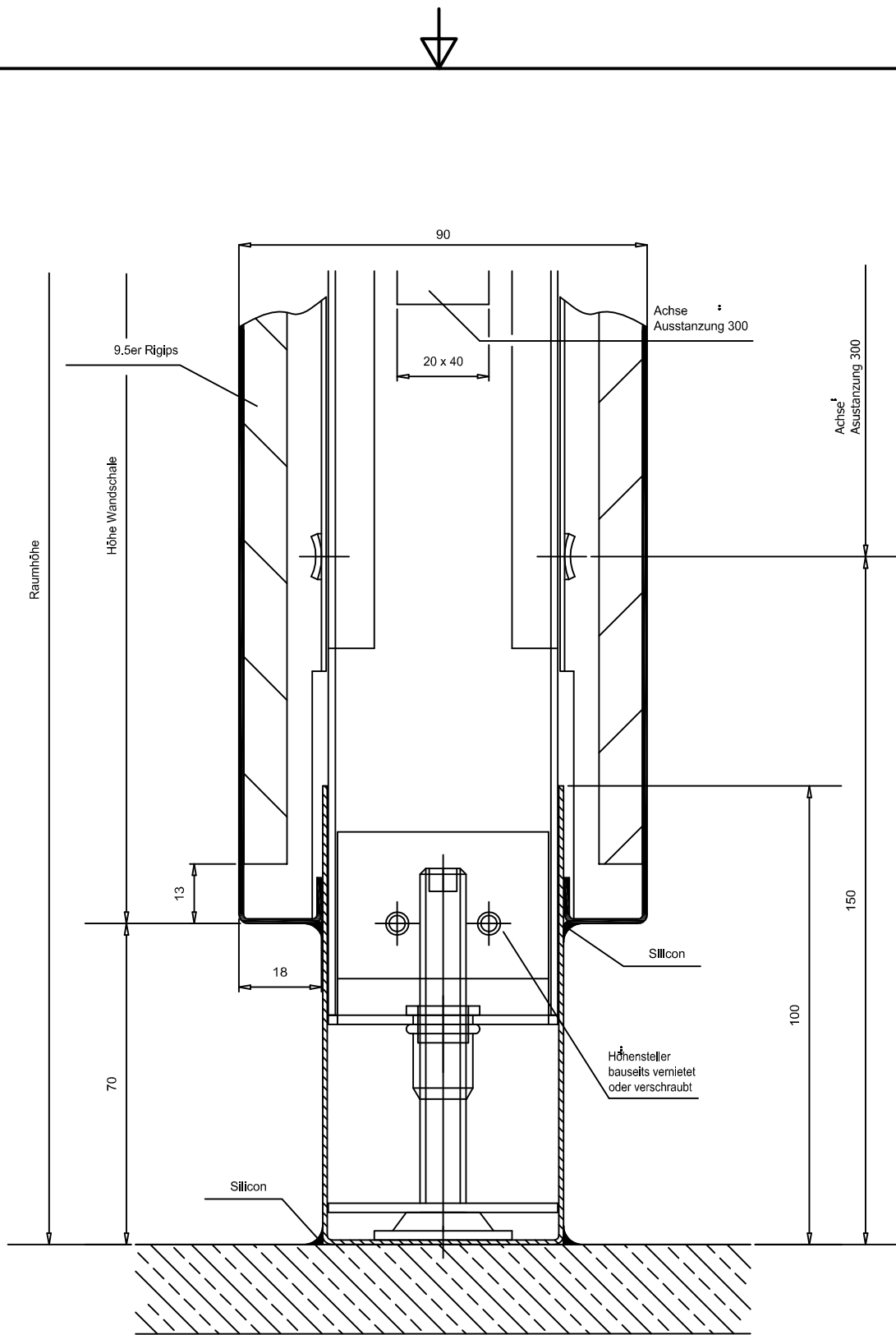

Alle Toleranzen nach DIN ISO 2768 mittel		Material		
This drawing is our literary property and may neither copied nor to be exposed approachable to third persons without our agreement; according to German Copyright Act				
		Datum	Name	Description / Bezeichnung: D 006 Sockelausbildung Wand-Bodenanschluss
		Gezeichnet	24.07.2014 jk	
		Kontrolliert		
		Norm		
		Projekt Nr. PRO_XXX		Z-Nr: VRS_P90_11_0005
Status	Änderungen	Datum	Name	1 A4

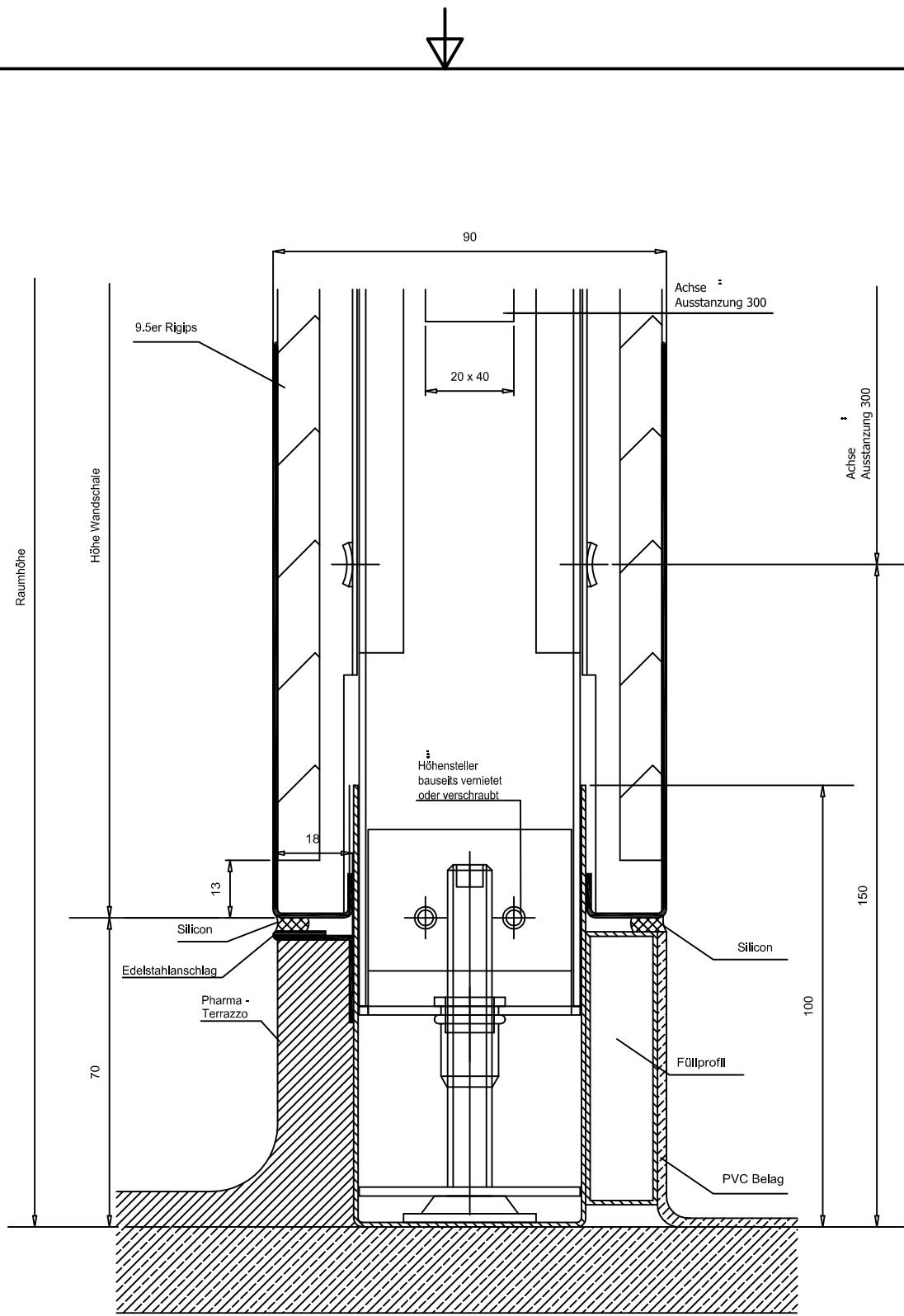

Alle Toleranzen nach DIN ISO 2768 mittel		Material		
<small>This drawing is our literary property and may neither copied nor to be exposed approachable to third persons without our agreement; according to German Copyright Act</small>				
		Datum	Name	Description / Bezeichnung: D 006 A Sockelausbildung Wand - Bodenanschluss Pharma - Terrazzo / PVC Belag
		Gezeichnet	24.07.2014 jk	
		Kontrolliert		
		Norm		
		Projekt Nr.		Z-Nr: VRS_P60_11_0006
		PRO_XXX		
Status	Änderungen	Datum	Name	1 A4

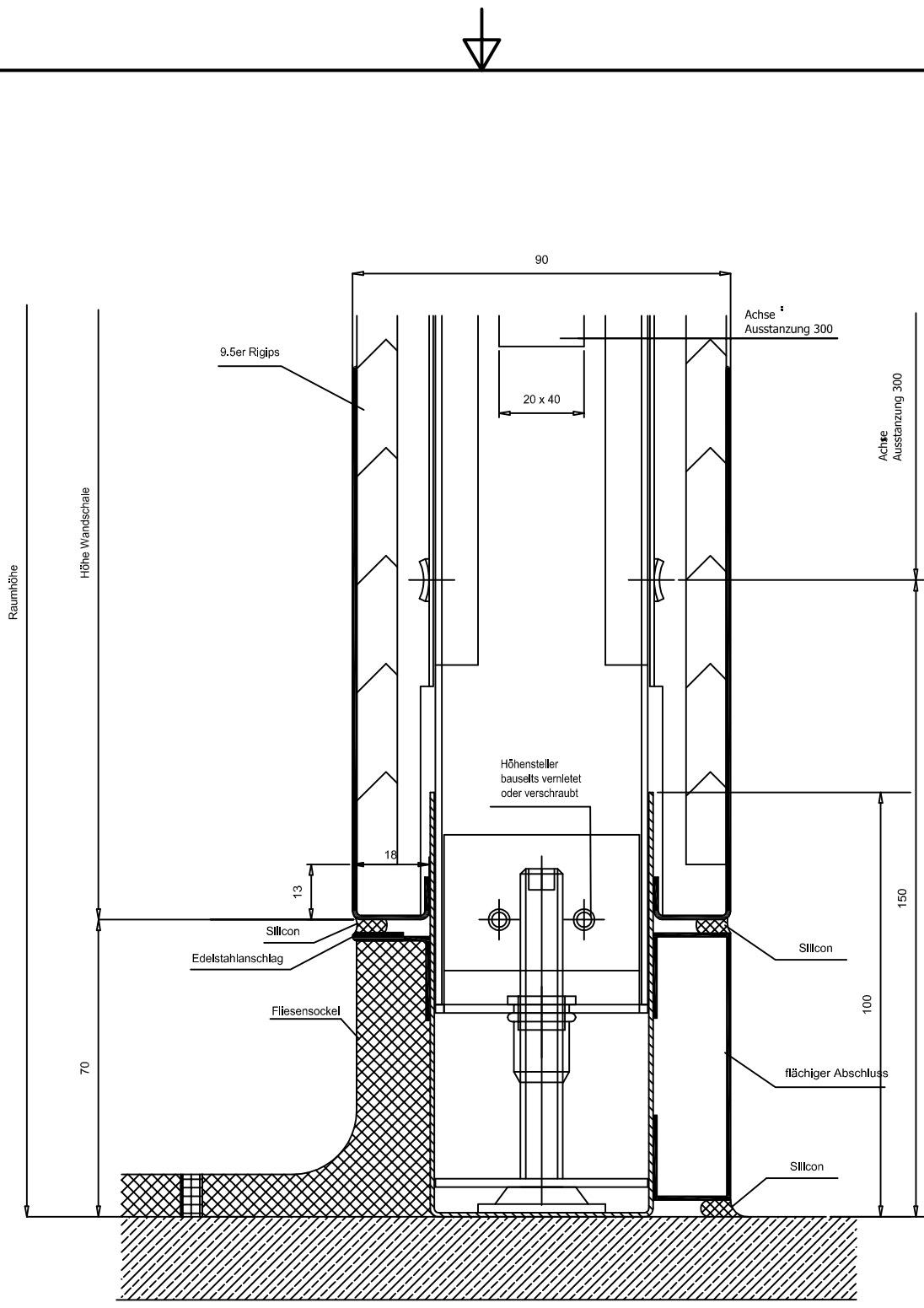

Alle Toleranzen nach DIN ISO 2768 mittel		Material		
<small>This drawing is our literary property and may neither copied nor to be exposed approachable to third persons without our agreement; according to German Copyright Act</small>				
		Datum	Name	Description / Bezeichnung: D 006 B Sockelausbildung Wand - Bodenanschluss Fliesenbelag/ flächiger Anschluss
		Gezeichnet	24.07.2014 jk	
		Kontrolliert		
		Norm		
		Projekt Nr.		Z-Nr: VRS_P60_11_0007
		PRO_XXX		
Status	Änderungen	Datum	Name	1 A4

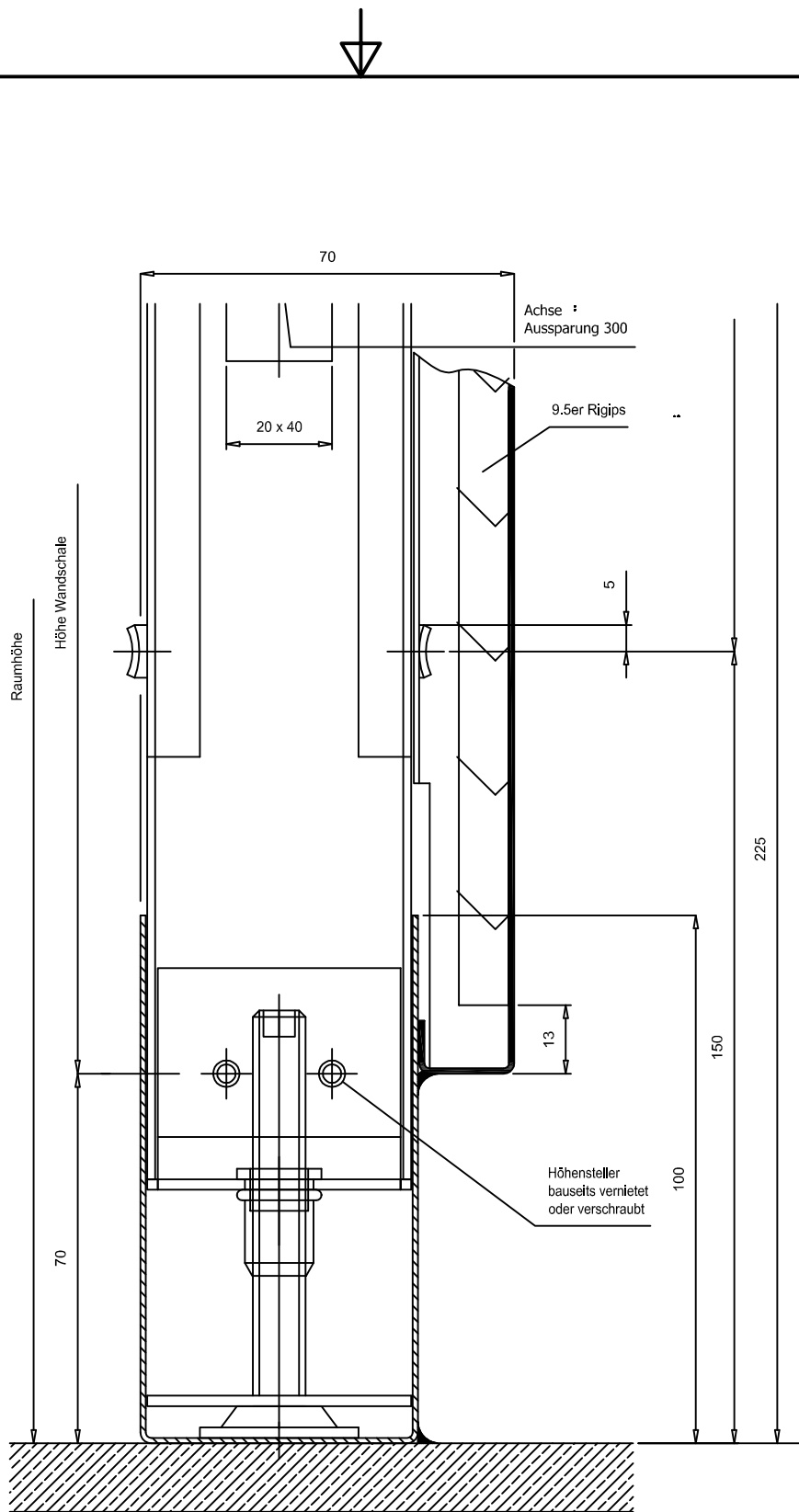

Alle Toleranzen nach DIN ISO 2768 mittel				Material			
This drawing is our literary property and may neither copied nor to be exposed approachable to third persons without our agreement; according to German Copyright Act							
			Datum	Name		Description / Bezeichnung: D 006 C Sockelausbildung halbe Wand Wand - Bodenanschluss	
			Gezeichnet	23.07.2014	jk		
			Kontrolliert				
			Norm				
			Projekt Nr.			Z-Nr: VRS_P60_11_0008	1
			PRO_XXX				
Status	Änderungen	Datum	Name				

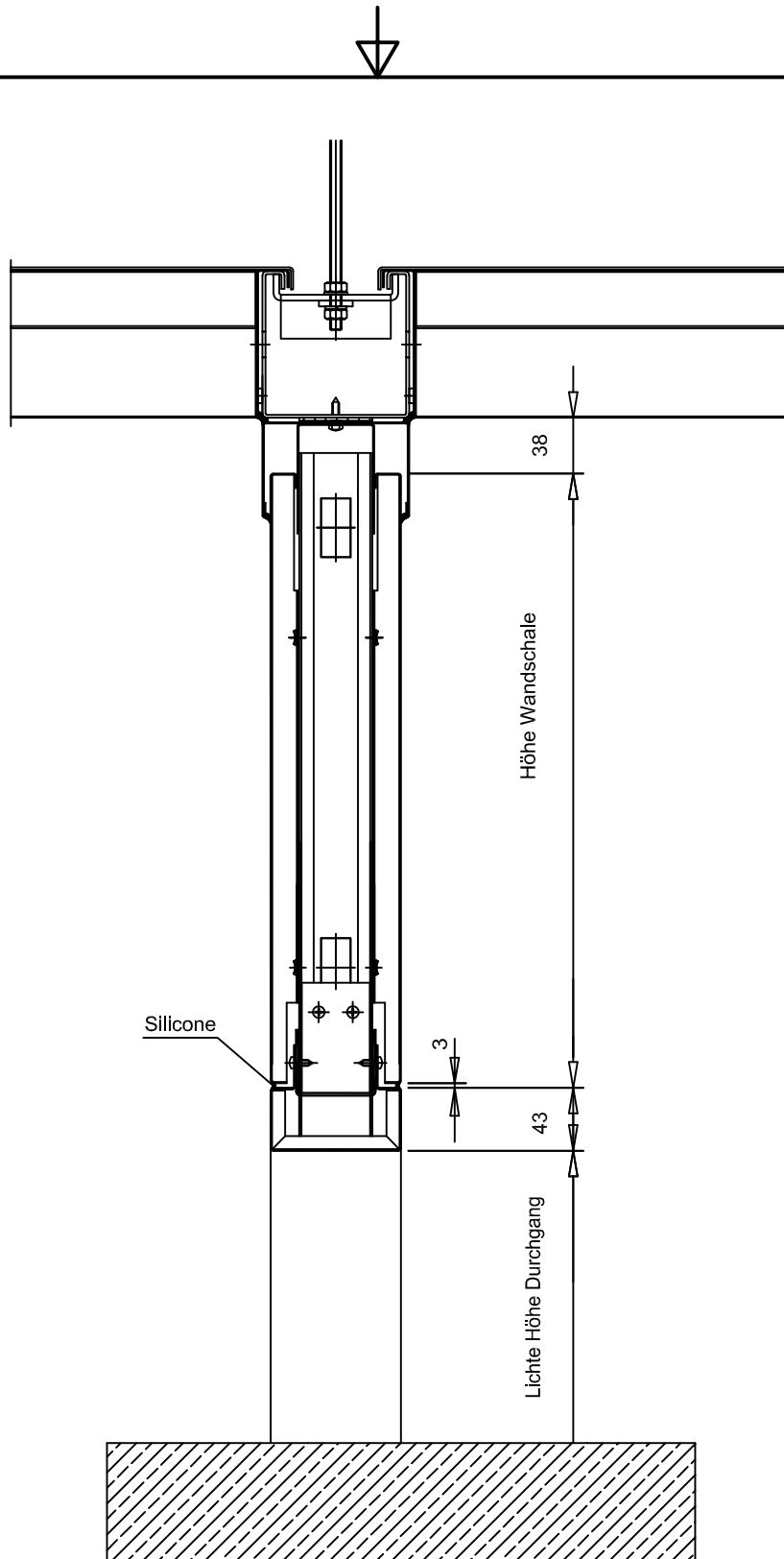

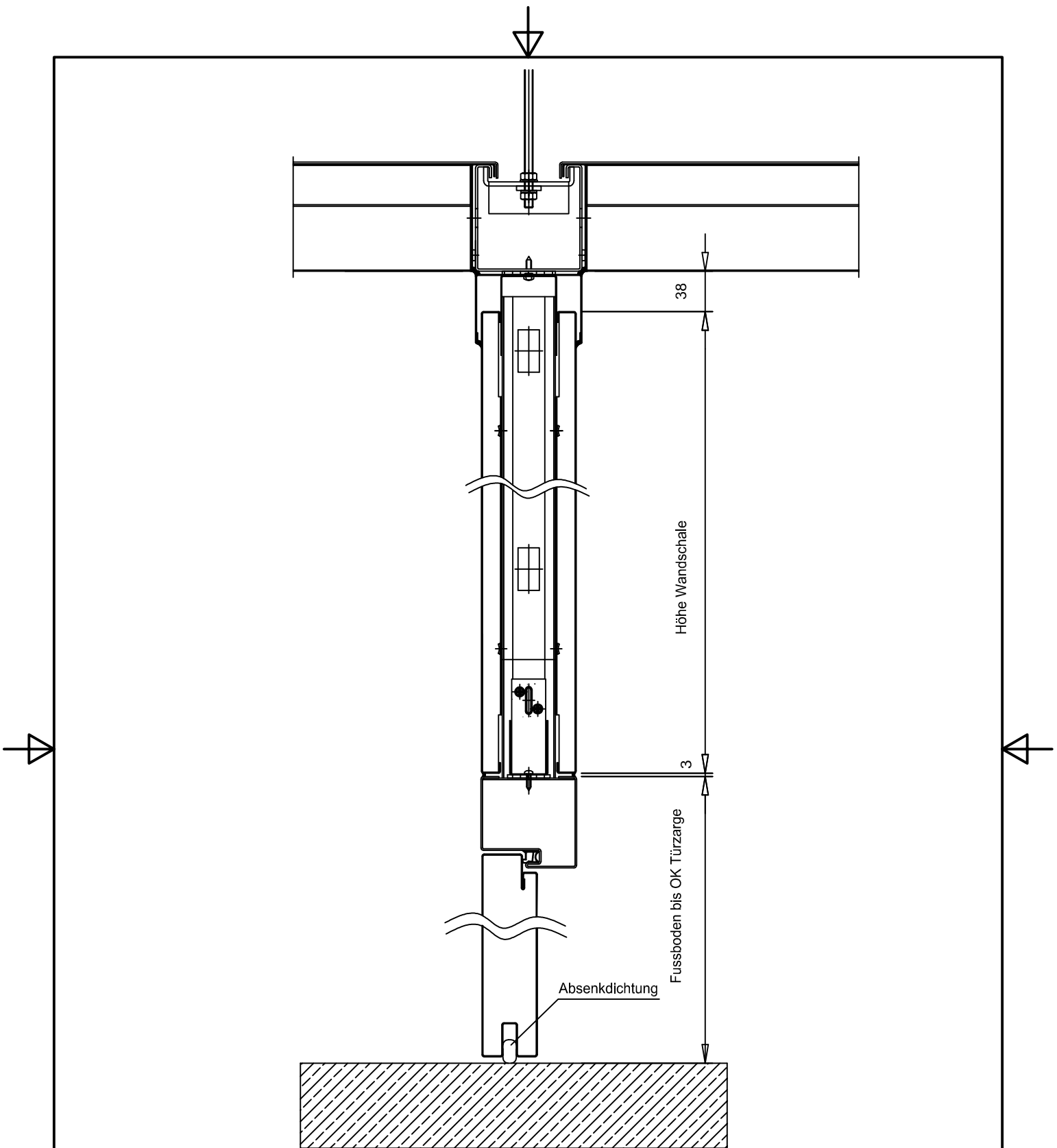

Alle Toleranzen nach DIN ISO 2768 mittel				Material		
This drawing is our literary property and may neither copied nor to be exposed approachable to third persons without our agreement; according to German Copyright Act						
				Datum	Name	Description / Bezeichnung: D 007 Durchgangsverkleidung Vertikalschnitt
				Gezeichnet	24.07.2014 jk	
				Kontrolliert		
				Norm		
				Projekt Nr. PRO_XXX		Z-Nr: VRS_P90_11_0009
						1
						A4
Status	Änderungen	Datum	Name			



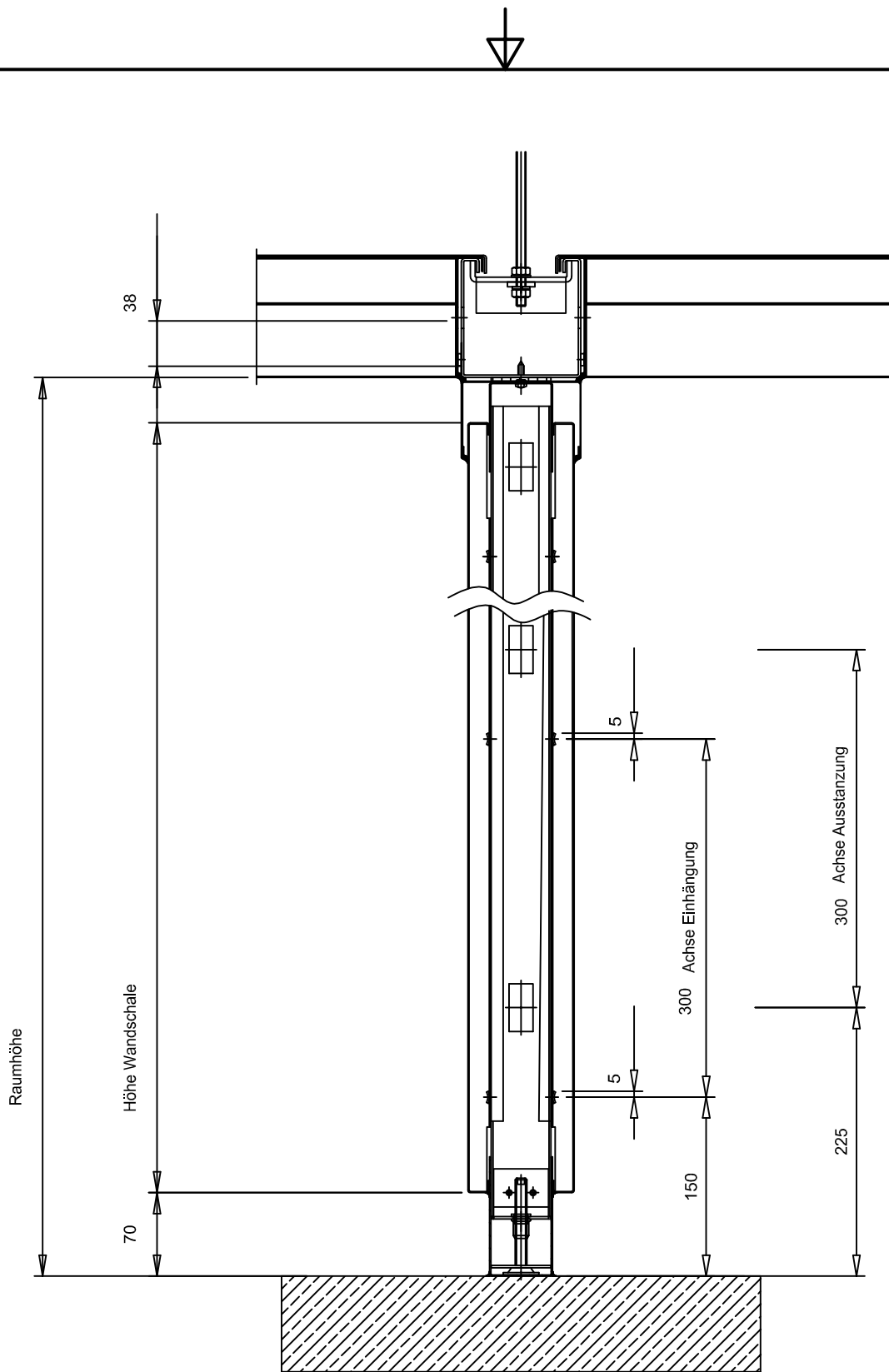

Alle Toleranzen nach DIN ISO 2768 mittel			Material			
This drawing is our literary property and may neither copied nor to be exposed approachable to third persons without our agreement; according to German Copyright Act						
			Datum	Name	Description / Bezeichnung: D 007 B Vertikalschnitt Trennwand Tür	
			Gezeichnet	24.07.2014		jk
			Kontrolliert			
			Norm			
			Projekt Nr. PRO_XXX		Z-Nr: VRS_P90_11_0011	
					1	
					A4	
Status	Änderungen	Datum	Name			





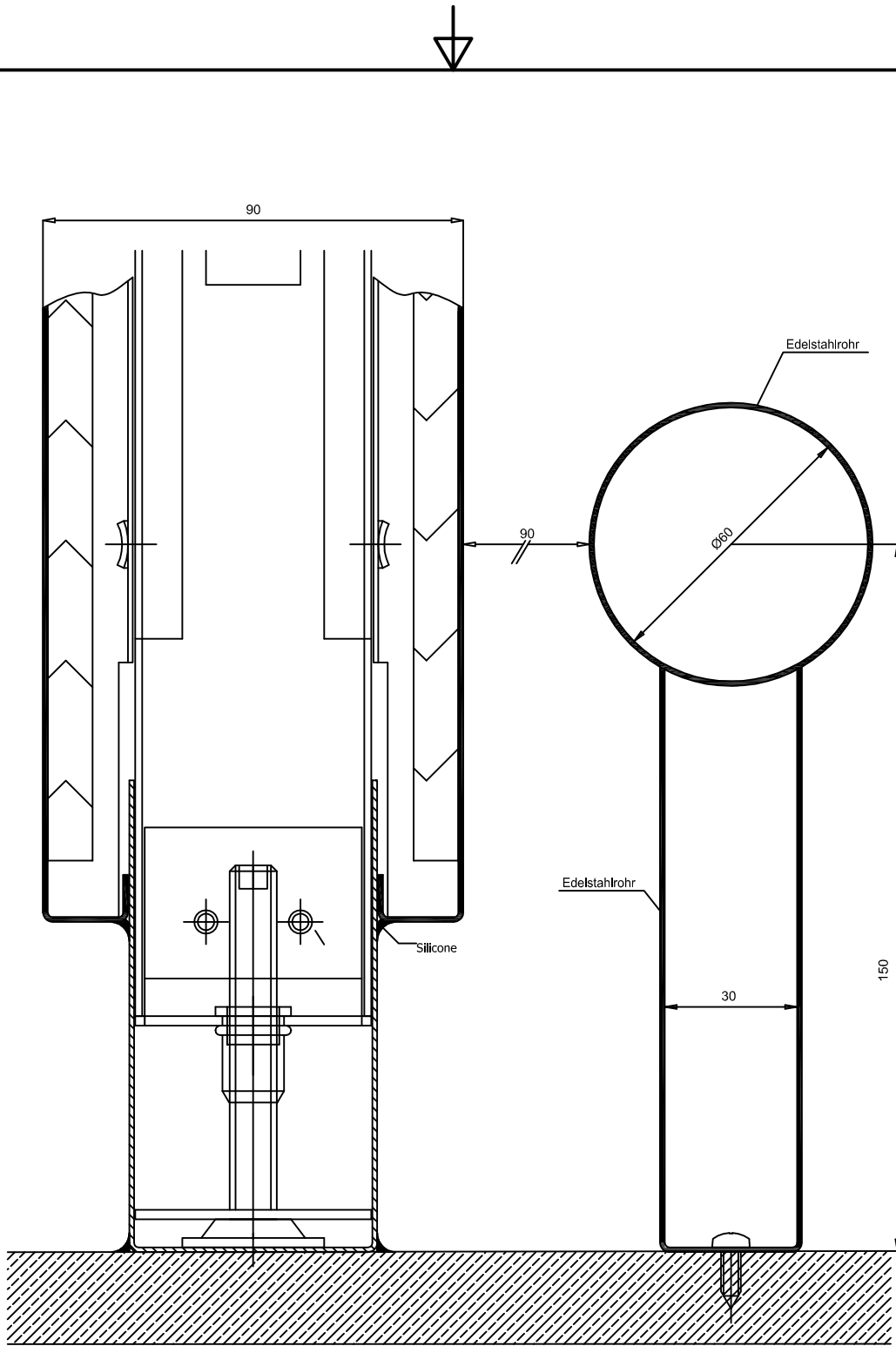

Alle Toleranzen nach DIN ISO 2768 mittel			Material		
This drawing is our literary property and may neither copied nor to be exposed approachable to third persons without our agreement; according to German Copyright Act					
			Datum	Name	Description / Bezeichnung: D 007 C Vertikalschnitt Trennwand Voll
			Gezeichnet	24.07.2014 jk	
			Kontrolliert		
			Norm		
			Projekt Nr. PRO_XXX		Z-Nr: VRS_P90_11_0012
					1
					A4
Status	Änderungen	Datum	Name		

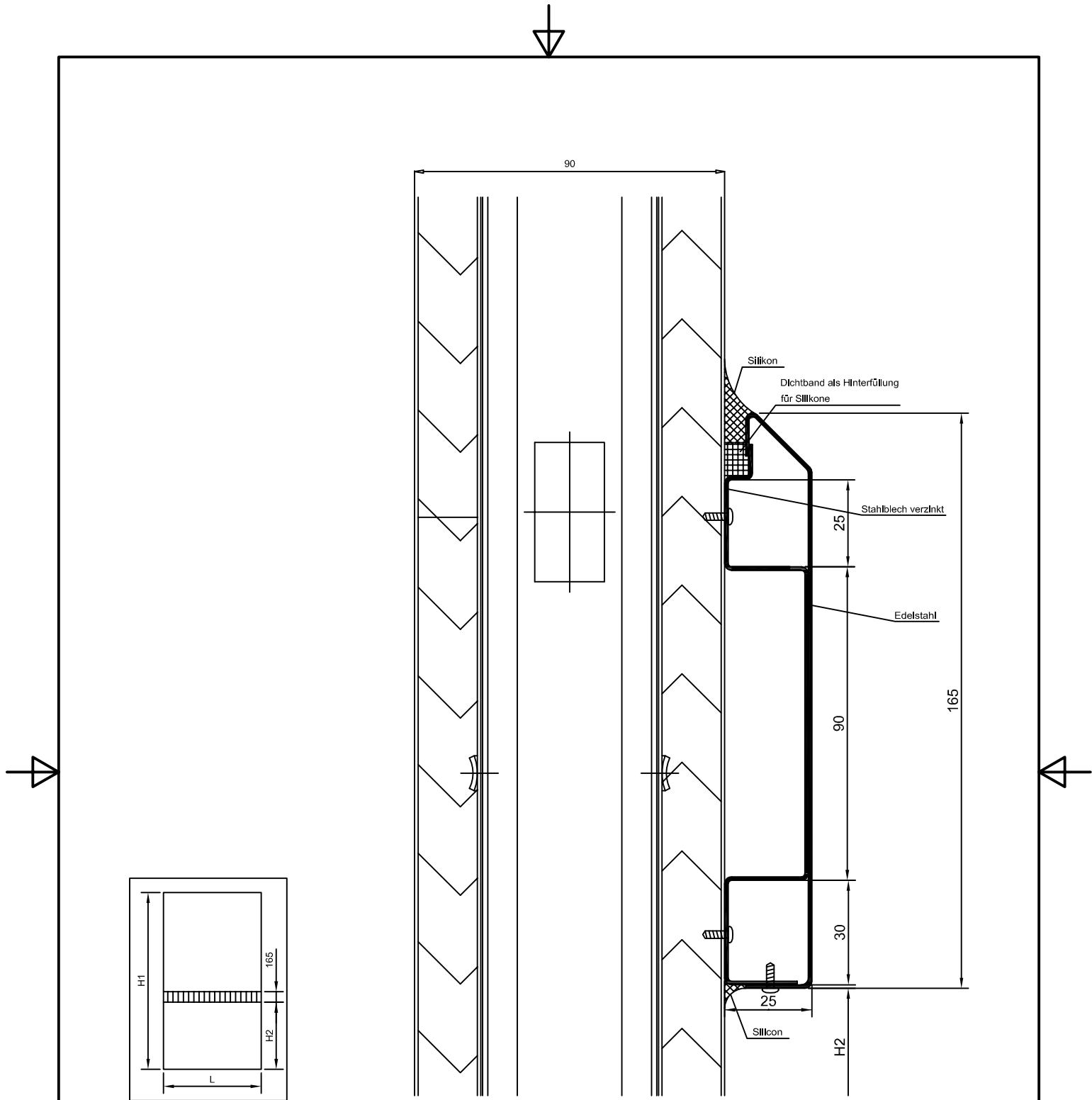

Alle Toleranzen nach DIN ISO 2768 mittel		Material			
This drawing is our literary property and may neither copied nor to be exposed approachable to third persons without our agreement; according to German Copyright Act					
		Datum	Name	Description / Bezeichnung: D 008 RammschutzFreistehend	
		Gezeichnet	25.07.2014 jk		
		Kontrolliert			
		Norm		Z-Nr: VRS_P90_11_0013	
		Projekt Nr. PRO_XXX			
Status	Änderungen	Datum	Name	A4	



Alle Toleranzen nach DIN ISO 2768 mittel				Material			
This drawing is our literary property and may neither copied nor to be exposed approachable to third persons without our agreement; according to German Copyright Act							
				Datum	Name	Description / Bezeichnung: D 008 A Schrammschutz	
				Gezeichnet	25.07.2014		jk
				Kontrolliert			
				Norm			
				Projekt Nr. PRO_XXX		Z-Nr: VRS_P90_11_0014	
						1	
						A4	
Status	Änderungen	Datum	Name				

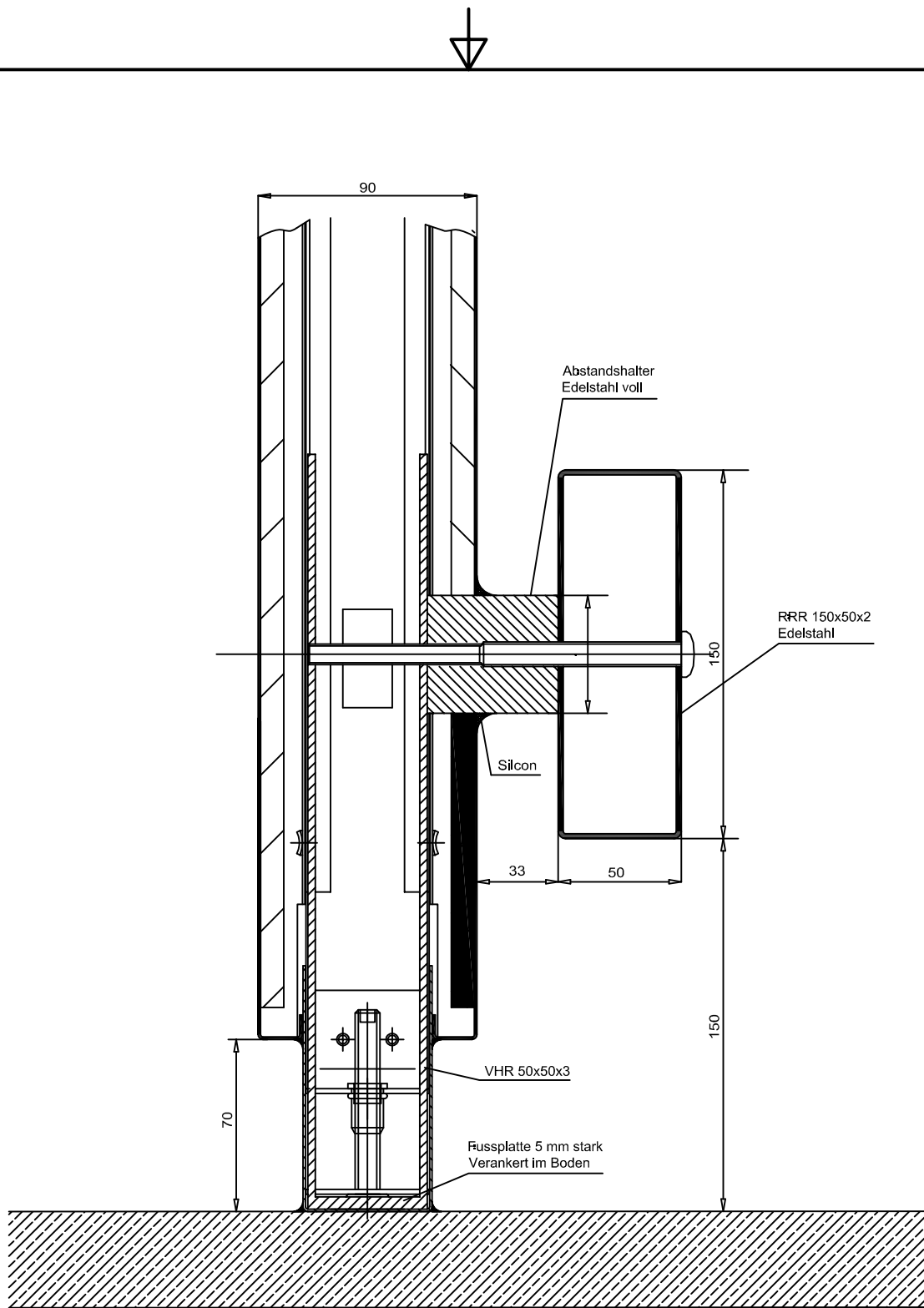

Alle Toleranzen nach DIN ISO 2768 mittel				Material			
This drawing is our literary property and may neither copied nor to be exposed approachable to third persons without our agreement; according to German Copyright Act							
				Datum	Name	Description / Bezeichnung: D 008 B Rammschutz an Reinraumwand	
				Gezeichnet	25.07.2014		jk
				Kontrolliert			
				Norm			
				Projekt Nr. PRO_XXX		Z-Nr: VRS_P90_11_0015	
						1	
						A4	
Status	Änderungen	Datum	Name				

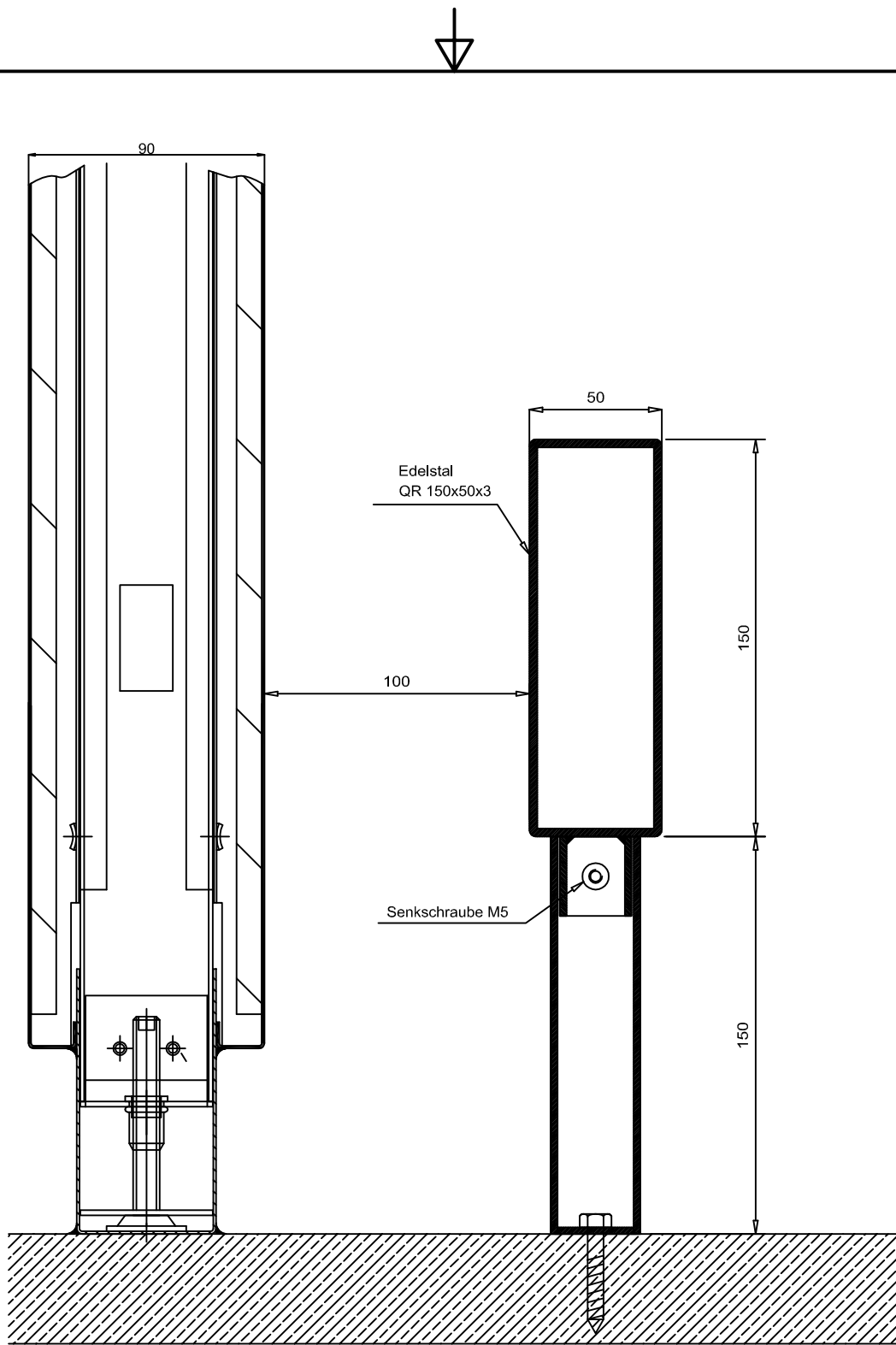

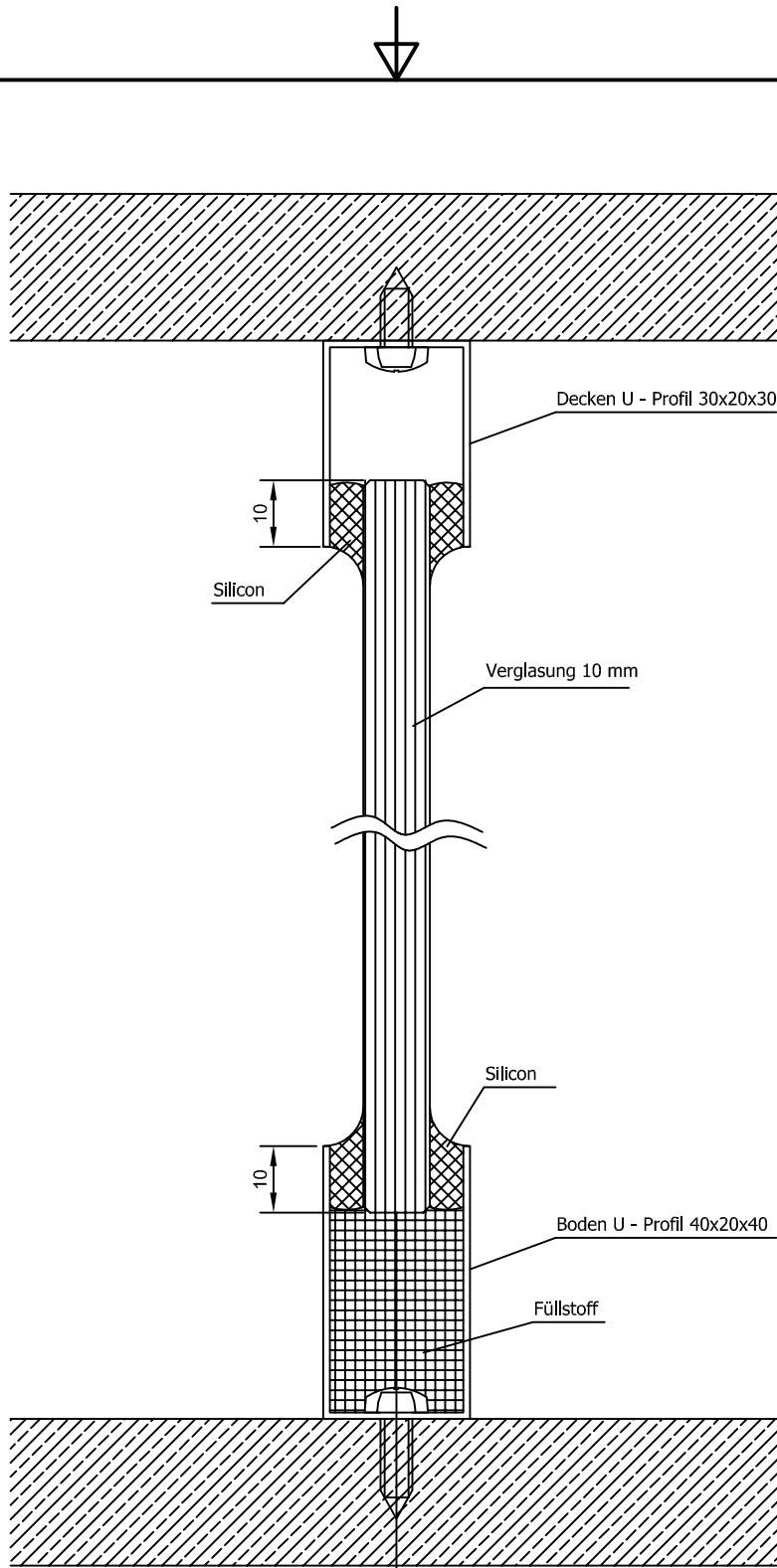

Alle Toleranzen nach DIN ISO 2768 mittel				Material		
This drawing is our literary property and may neither copied nor to be exposed approachable to third persons without our agreement; according to German Copyright Act						
			Datum	Name		Description / Bezeichnung: D 008 C Rammschutz freistehend rechteckig
			Gezeichnet	25.07.2014	jk	
			Kontrolliert			
			Norm			
			Projekt Nr.			Z-Nr: VRS_P90_11_0016
			PRO_XXX			
Status	Änderungen	Datum	Name			1 A4

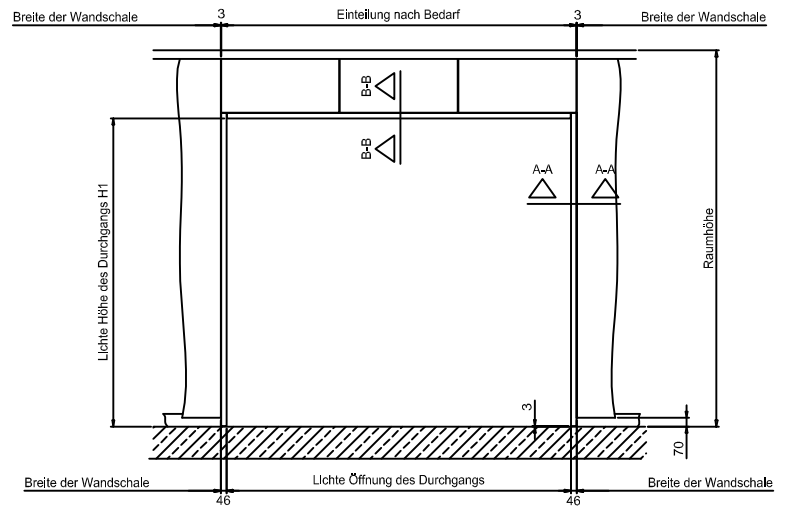
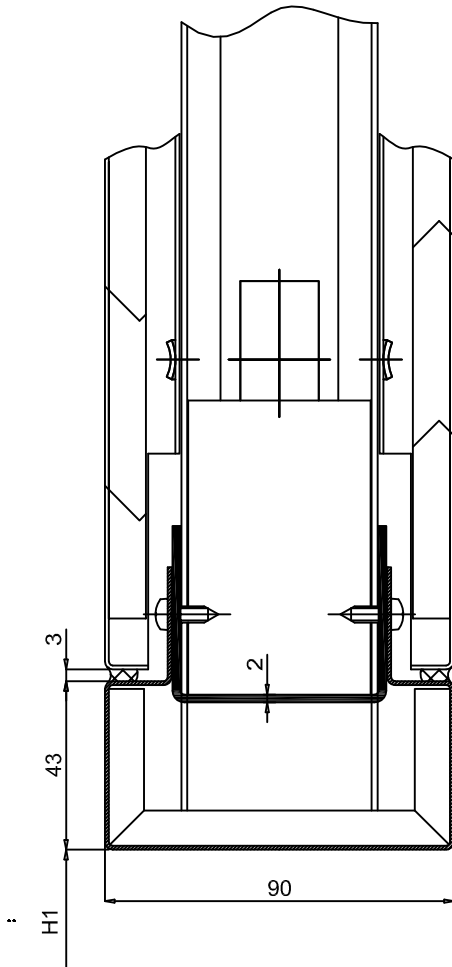

Alle Toleranzen nach DIN ISO 2768 mittel				Material		
This drawing is our literary property and may neither copied nor to be exposed approachable to third persons without our agreement; according to German Copyright Act						
				Datum	Name	Description / Bezeichnung: D 009 Glaswand
				Gezeichnet	25.07.2014 jk	
				Kontrolliert		
				Norm		
				Projekt Nr. PRO_XXX		Z-Nr: VRS_P90_11_0017
						1
						A4
Status	Änderungen	Datum	Name			

Schnitt B-B



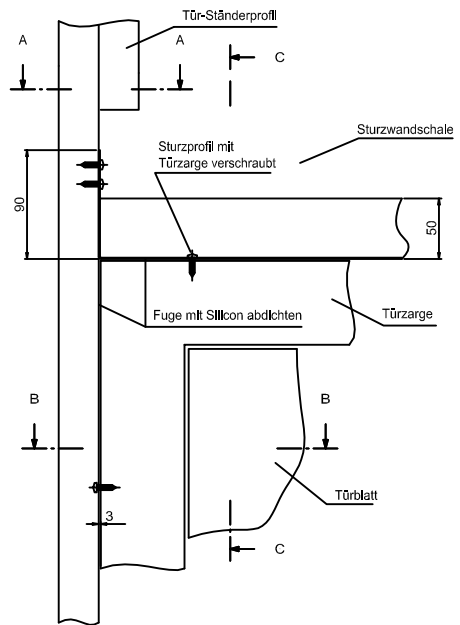
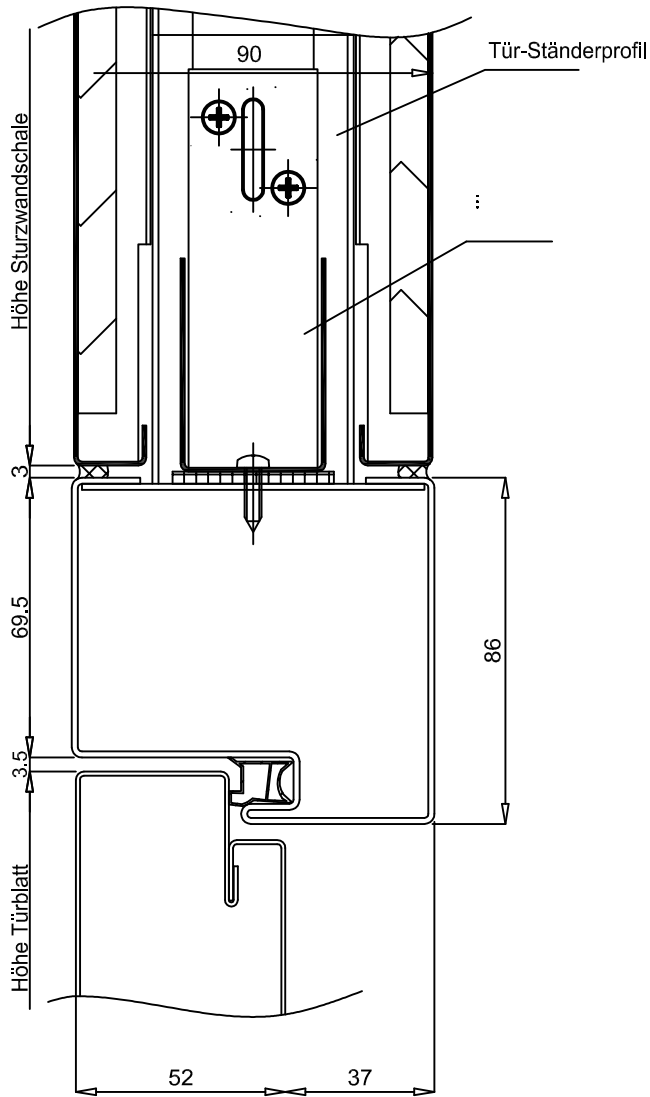

Alle Toleranzen nach DIN ISO 2768 mittel				Material		
This drawing is our literary property and may neither copied nor to be exposed approachable to third persons without our agreement; according to German Copyright Act						
				Datum	Name	Description / Bezeichnung: D 010 Durchgangszarge
				Gezeichnet	25.07.2014 jk	
				Kontrolliert		
				Norm		
				Projekt Nr. PRO_XXX		Z-Nr: VRS_P90_11_0018
						1
						A4
Status	Änderungen	Datum	Name			

Schnitt C-C

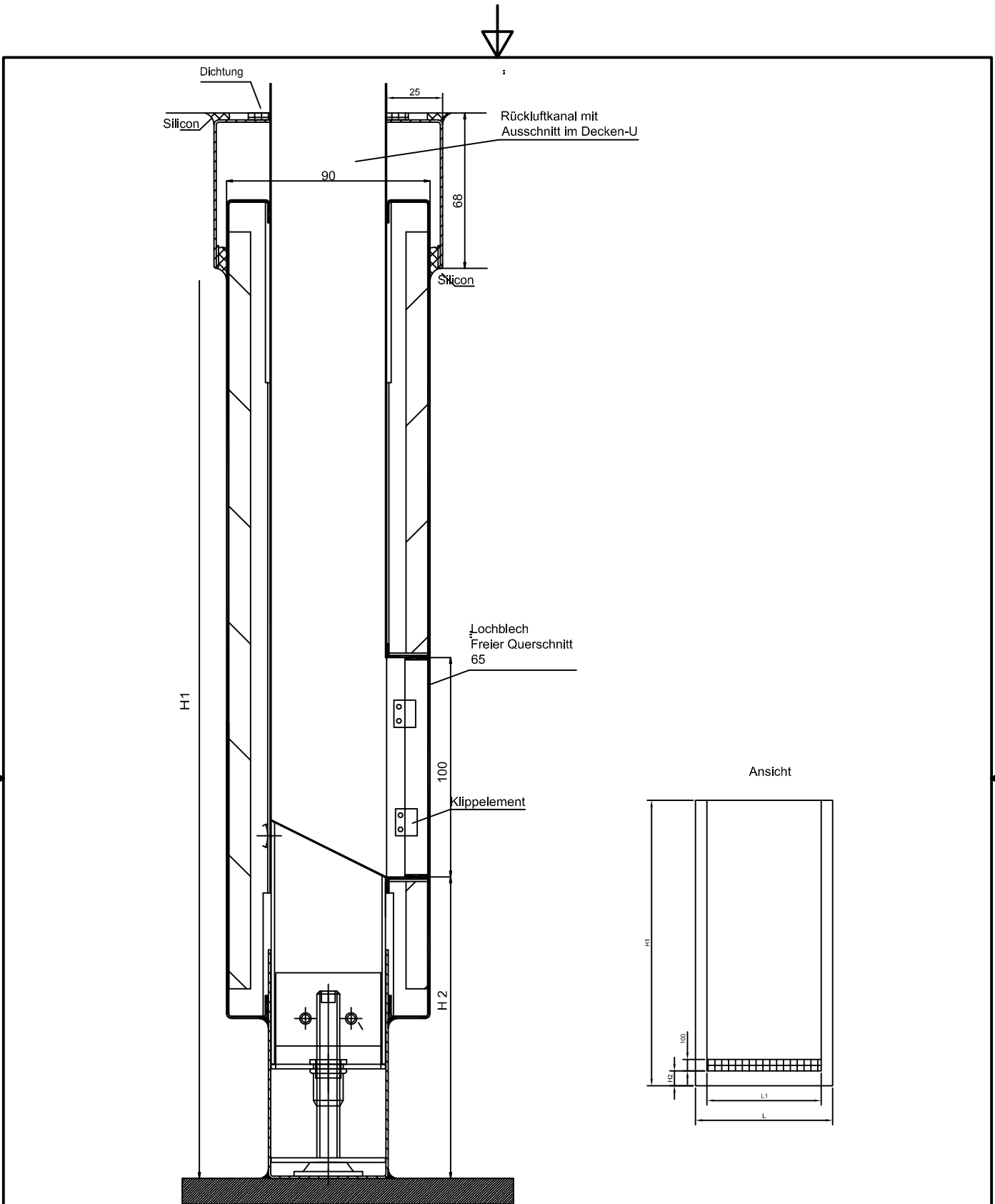

Alle Toleranzen nach DIN ISO 2768 mittel		Material			
<small>This drawing is our literary property and may neither copied nor to be exposed approachable to third persons without our agreement; according to German Copyright Act</small>					
		Datum	Name		
		Gezeichnet	25.07.2014	jk	
		Kontrolliert			
		Norm			
Projekt Nr.				Z-Nr: VRS_P90_11_0019	
PRO_XXX				1	
Status	Änderungen	Datum	Name	A4	



Alle Toleranzen nach DIN ISO 2768 mittel				Material			
This drawing is our literary property and may neither copied nor to be exposed approachable to third persons without our agreement; according to German Copyright Act							
				Datum	Name	Description / Bezeichnung: D 013 Rücklaufschacht integriert	
			Gezeichnet	25.07.2014	jk		
			Kontrolliert				
			Norm				
			Projekt Nr. PRO_XXX			Z-Nr: VRS_P90_11_0020	1
Status	Änderungen	Datum	Name			A4	

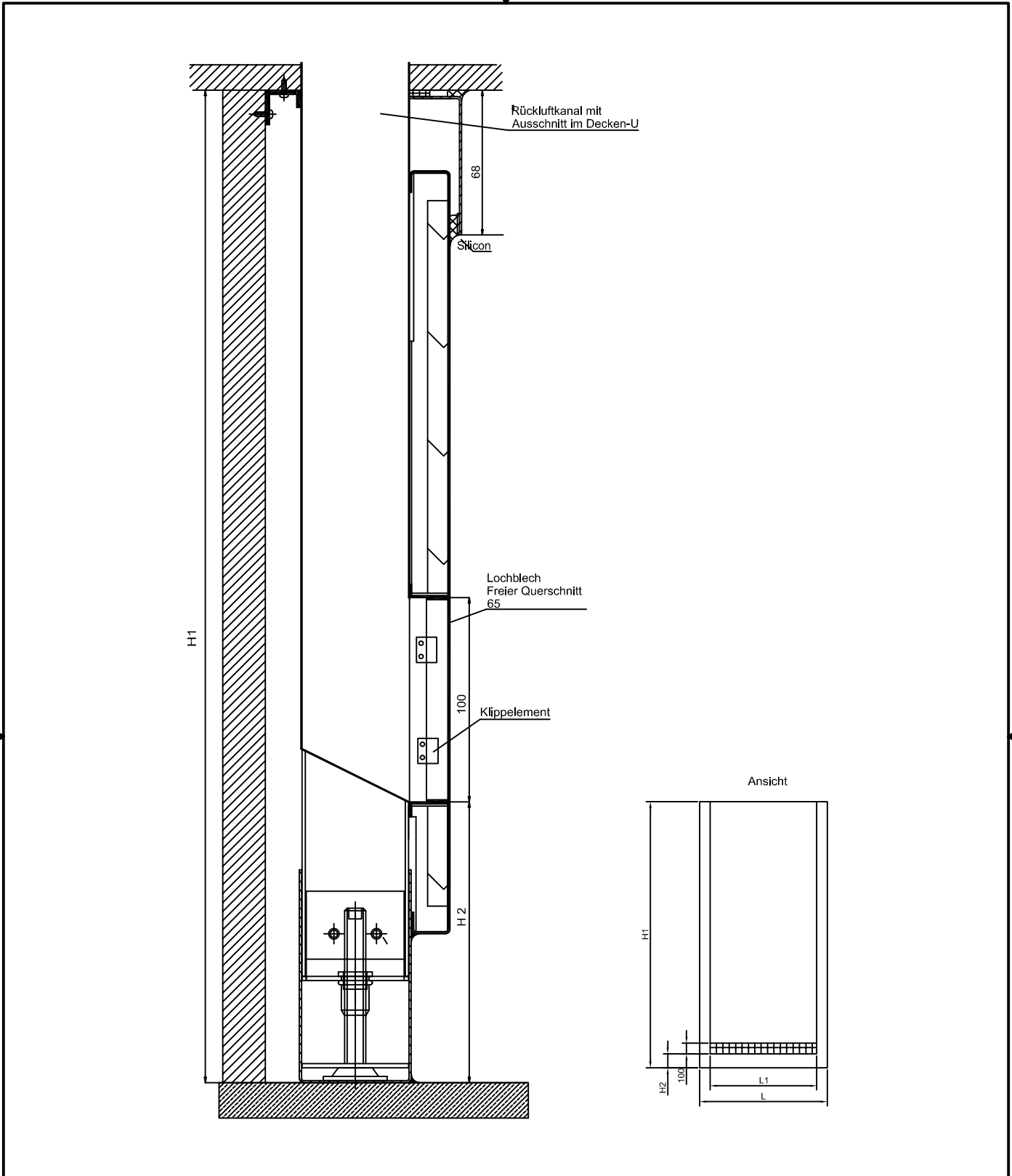

Alle Toleranzen nach DIN ISO 2768 mittel This drawing is our literary property and may neither copied nor to be exposed approachable to third persons without our agreement; according to German Copyright Act				Material		
				Datum 25.07.2014 Name jk	Description / Bezeichnung: D 013 A Rücklaufschacht integriert mit Wandverkleidung	
				Gezeichnet 25.07.2014 Kontrolliert Norm		
				Projekt Nr. PRO_XXX		Z-Nr: VRS_P90_11_0021
						1 A4
Status	Änderungen	Datum	Name			

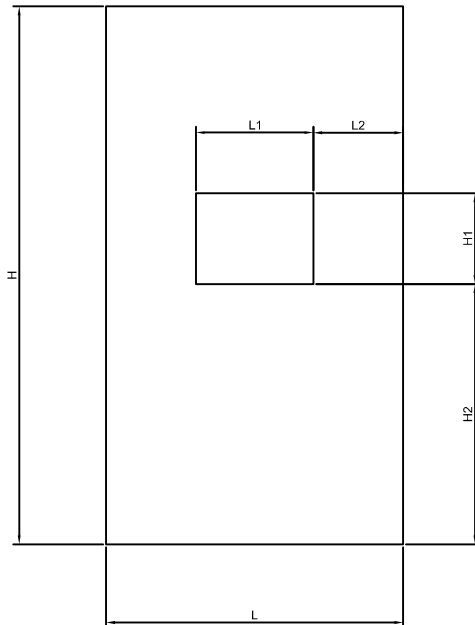
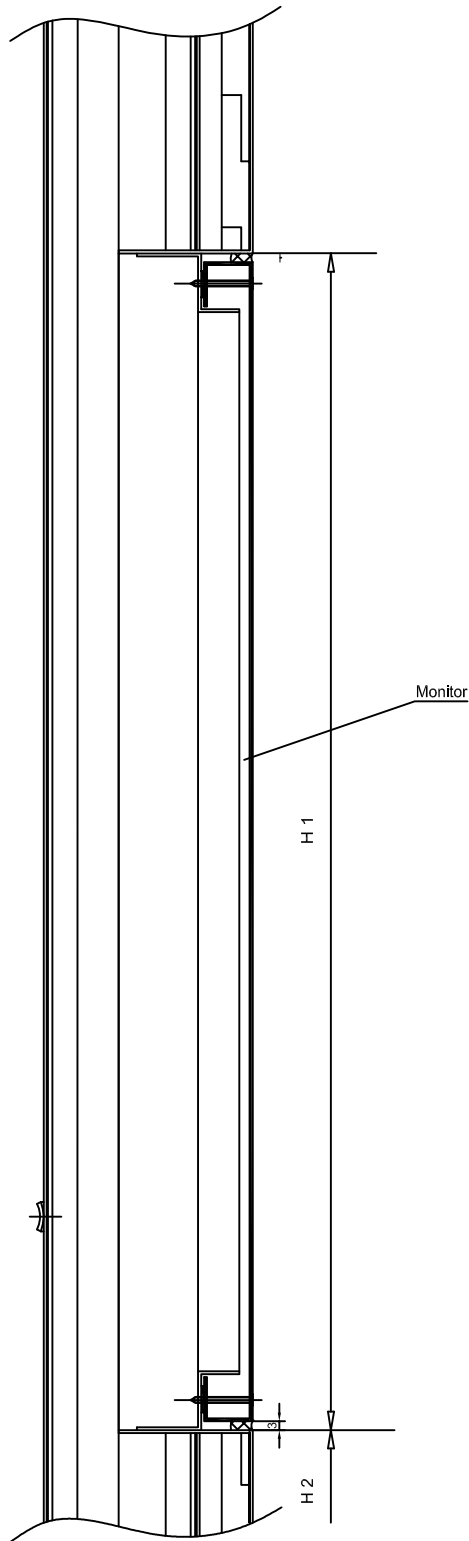

Alle Toleranzen nach DIN ISO 2768 mittel				Material			
This drawing is our literary property and may neither copied nor to be exposed approachable to third persons without our agreement; according to German Copyright Act							
				Datum	Name	Description / Bezeichnung: D 013 B Installation Trennwand halb	
			Gezeichnet	25.07.2014	jk		
			Kontrolliert				
			Norm				
			Projekt Nr. PRO_XXX			Z-Nr: VRS_P90_11_0022	1
Status	Änderungen	Datum	Name			A4	

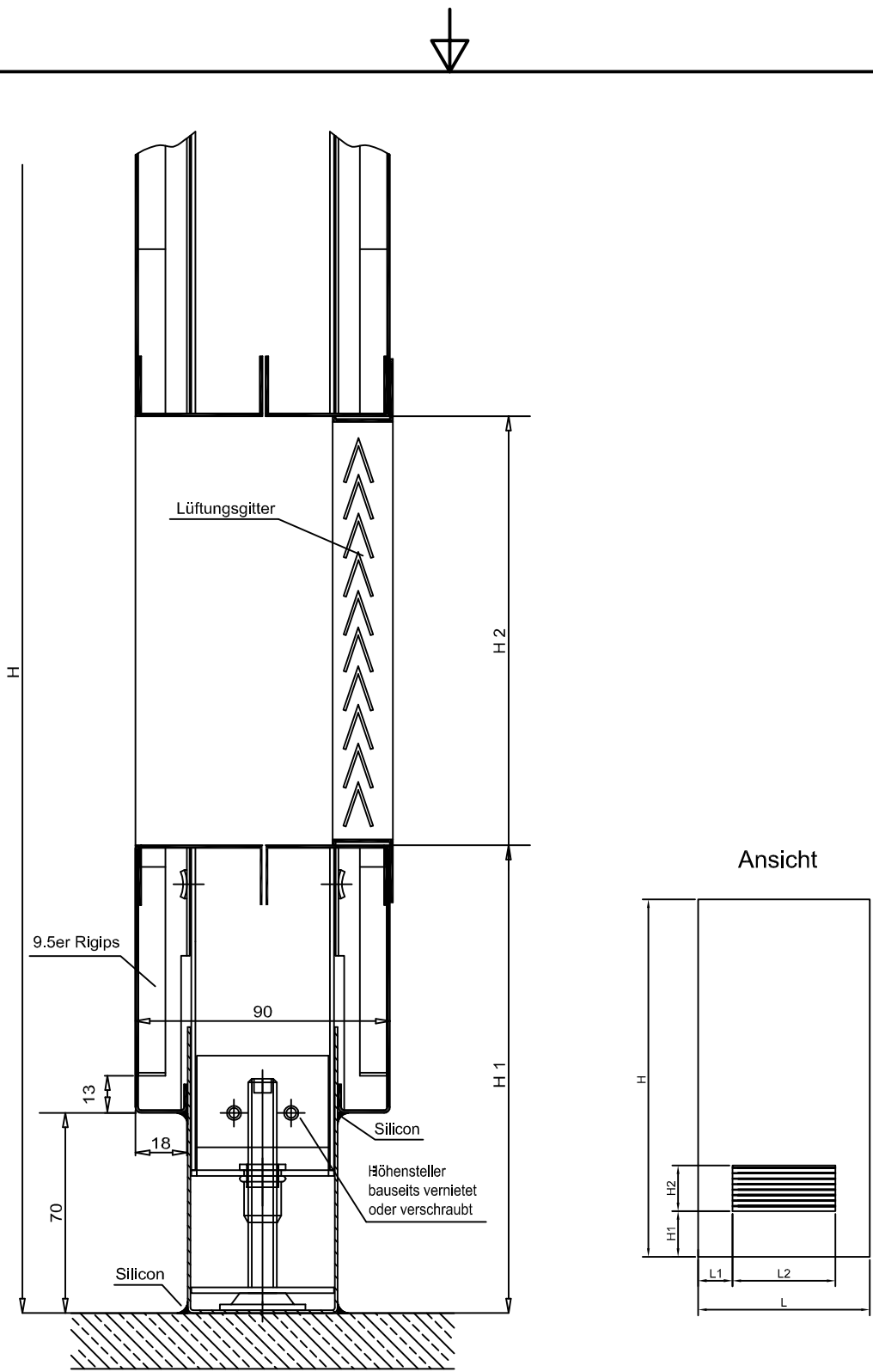

Alle Toleranzen nach DIN ISO 2768 mittel				Material			
This drawing is our literary property and may neither copied nor to be exposed approachable to third persons without our agreement; according to German Copyright Act							
			Datum	Name		Description / Bezeichnung: D 013 C Lüftungsgitter übergreifend	
			Gezeichnet	25.07.2014	jk		
			Kontrolliert				
			Norm				
			Projekt Nr. PRO_XXX			Z-Nr: VRS_P90_11_0023	1
Status	Änderungen	Datum	Name			A4	



Schnitt B-B

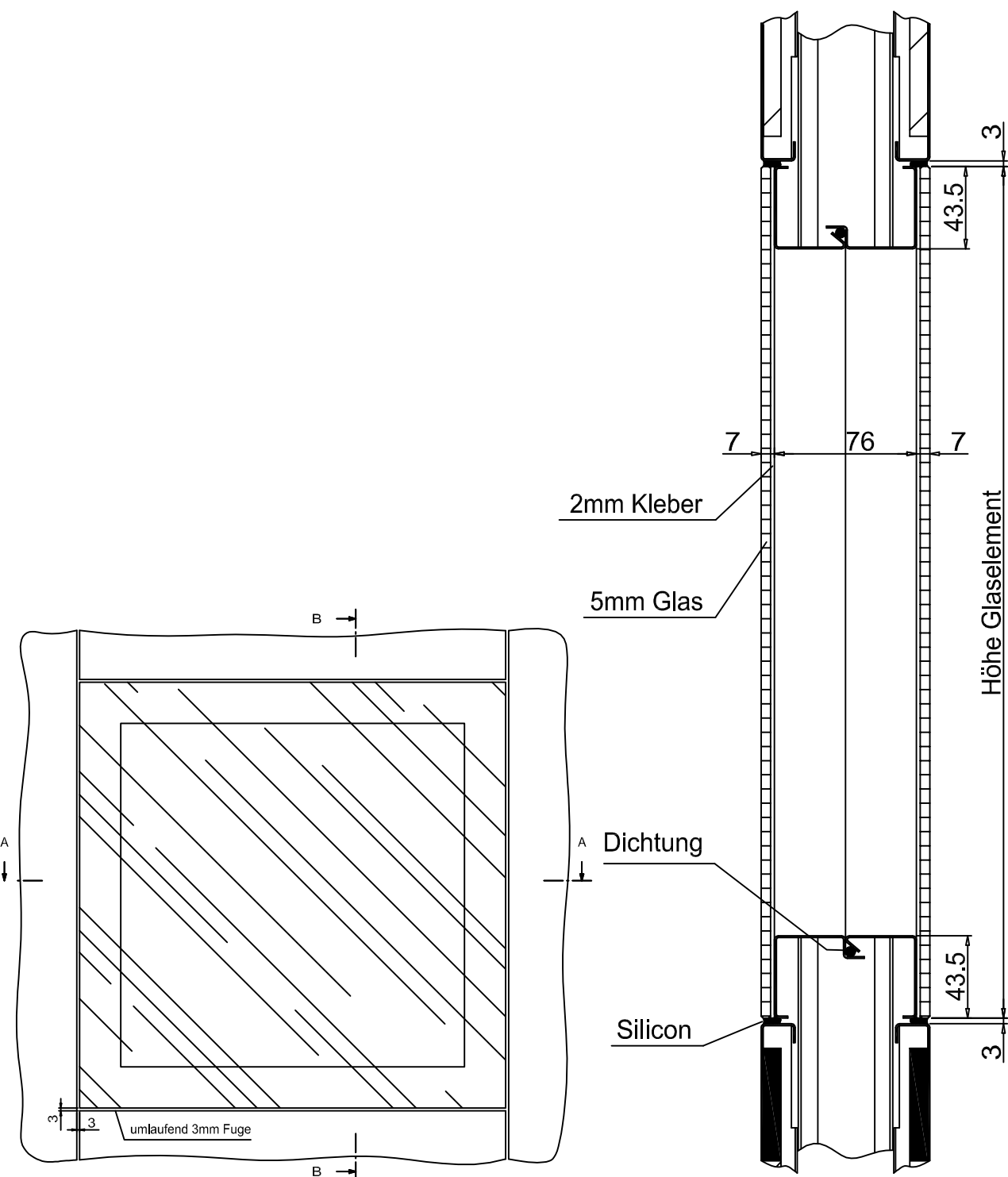

Alle Toleranzen nach DIN ISO 2768 mittel				Material	
This drawing is our literary property and may neither copied nor to be exposed approachable to third persons without our agreement; according to German Copyright Act					
			Datum	Name	
			Gezeichnet	25-07-2014	jk
			Kontrolliert		
			Norm		
			Projekt Nr.		
			PRO_XXX		
Status	Änderungen	Datum	Name		





Description / Bezeichnung:
D 014 A Trennwandverglasung

Z-Nr: VRS_P90_11_0024

1
A4

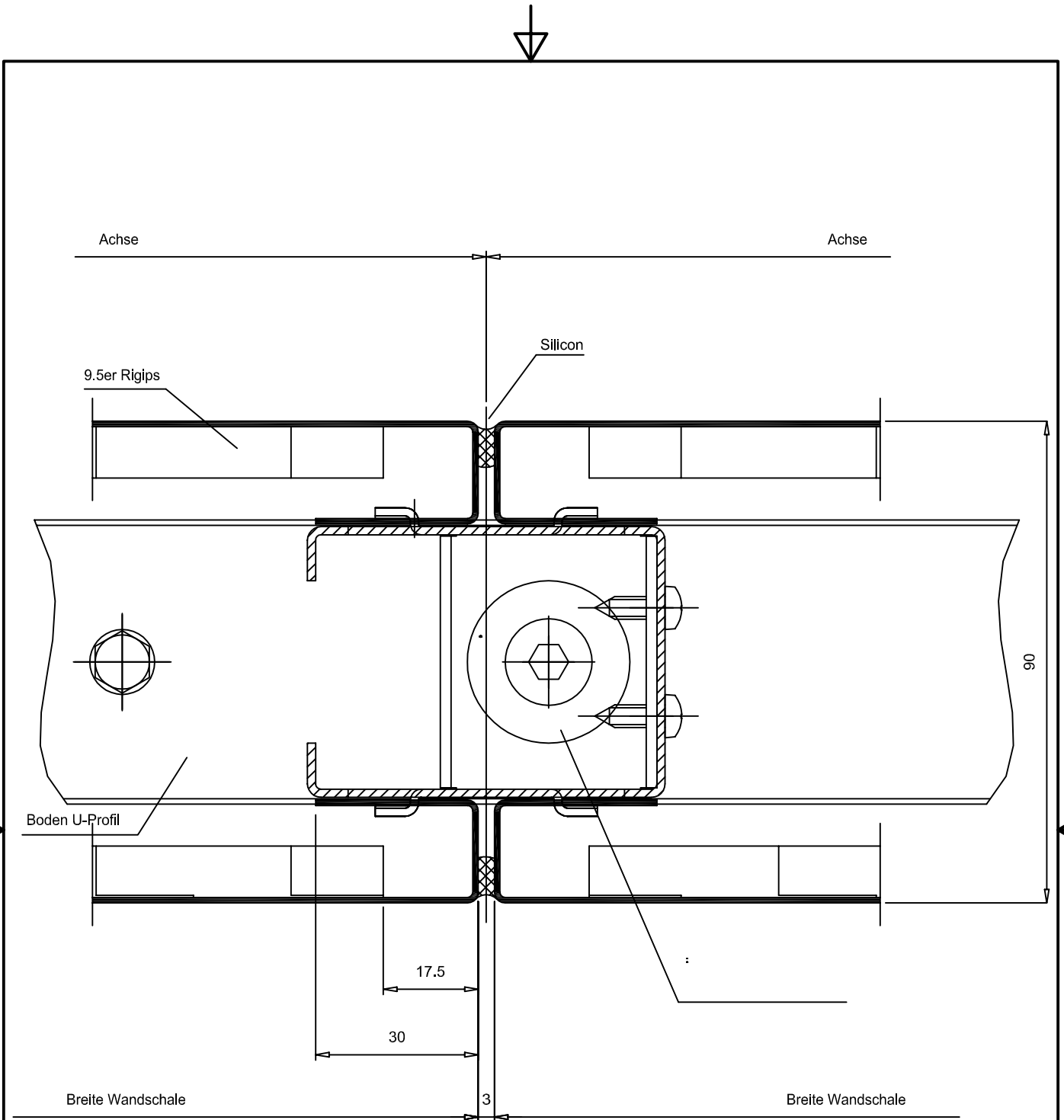



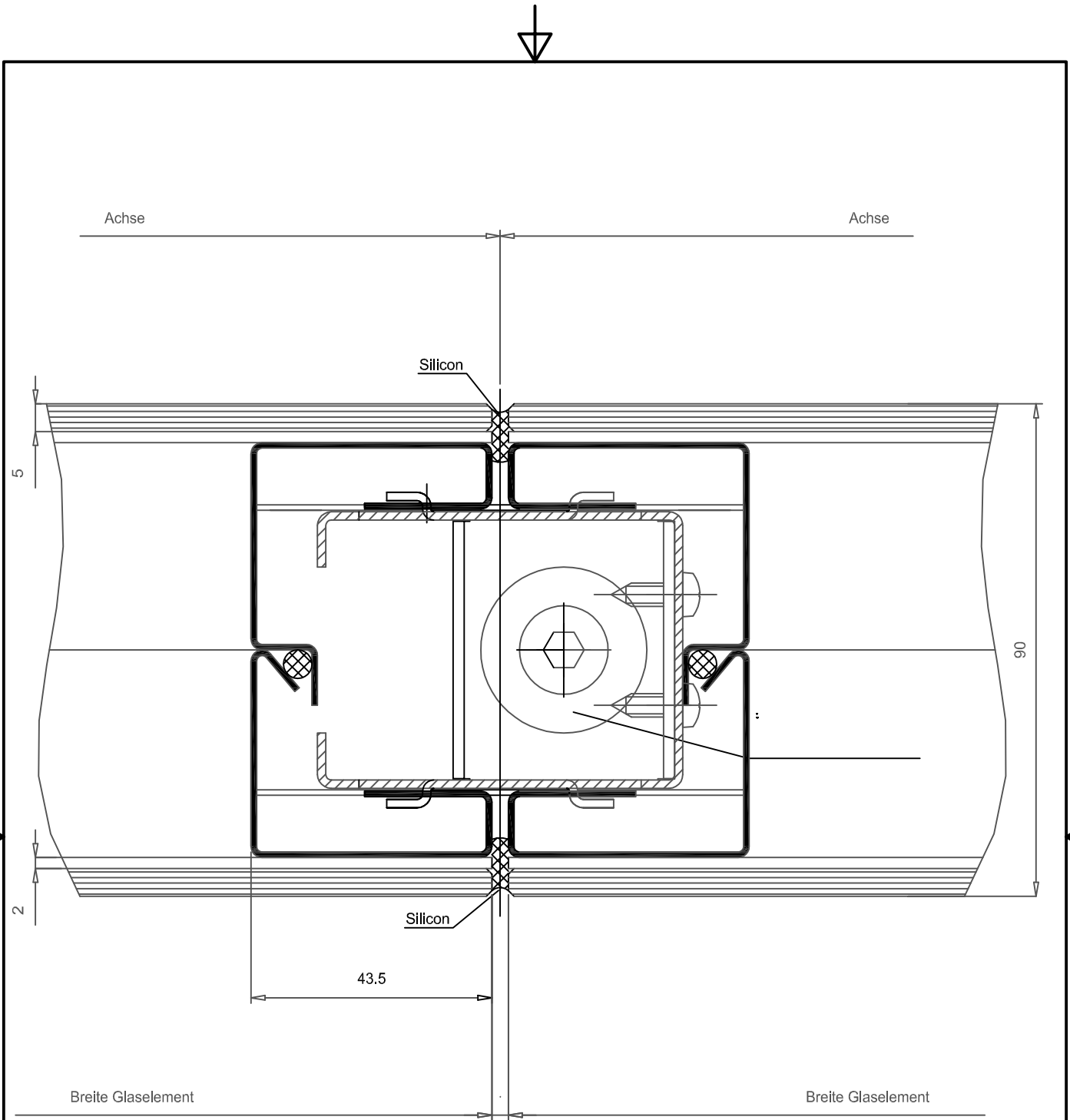

Alle Toleranzen nach DIN ISO 2768 mittel				Material			
This drawing is our literary property and may neither copied nor to be exposed approachable to third persons without our agreement; according to German Copyright Act							
				Datum	Name	Description / Bezeichnung: D 001 Trennwand voll	
				Gezeichnet	16.07.2014		jk
				Kontrolliert			
				Norm			
				Projekt Nr. PRO_XXX		Z-Nr: VRS_P90_12_0001	
						1	
						A4	
Status	Änderungen	Datum	Name				

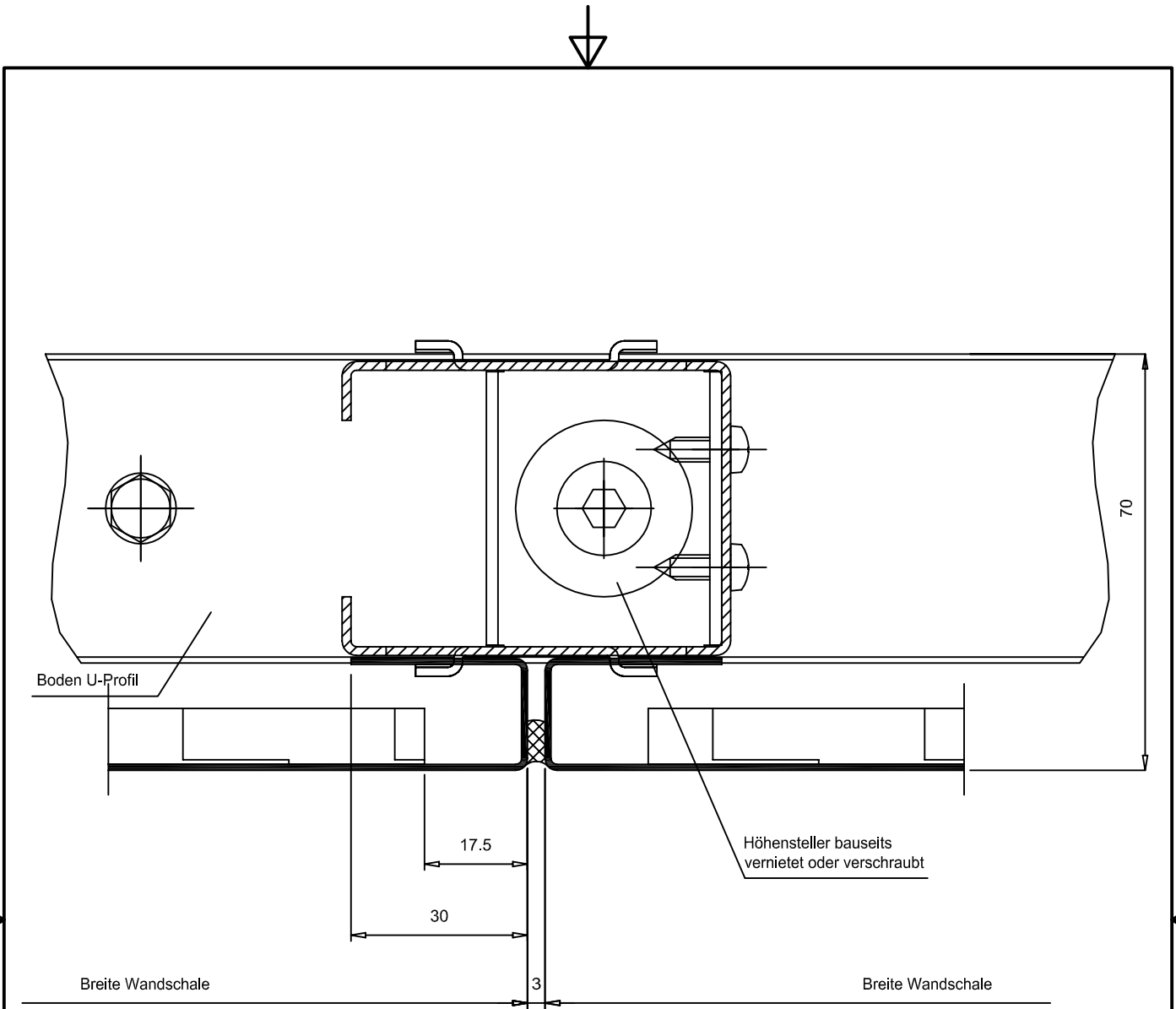

Alle Toleranzen nach DIN ISO 2768 mittel				Material			
This drawing is our literary property and may neither copied nor to be exposed approachable to third persons without our agreement; according to German Copyright Act							
				Datum	Name	Description / Bezeichnung: D 001A Trennwand zweifach Verglasung	
				Gezeichnet	16.07.2014		jk
				Kontrolliert			
				Norm			
				Projekt Nr. PRO_XXX		Z-Nr: VRS_P90_12_0002	
						1	
						A4	
Status	Änderungen	Datum	Name				



Alle Toleranzen nach DIN ISO 2768 mittel			Material		
This drawing is our literary property and may neither copied nor to be exposed approachable to third persons without our agreement; according to German Copyright Act					
			Datum	Name	Description / Bezeichnung: D 001 B Trennwand halb
			Gezeichnet	16.07.2014 jk	
			Kontrolliert		
			Norm		
			Projekt Nr. PRO_XXX		Z-Nr: VRS_P90_12_0003
					1
					A4
Status	Änderungen	Datum	Name		

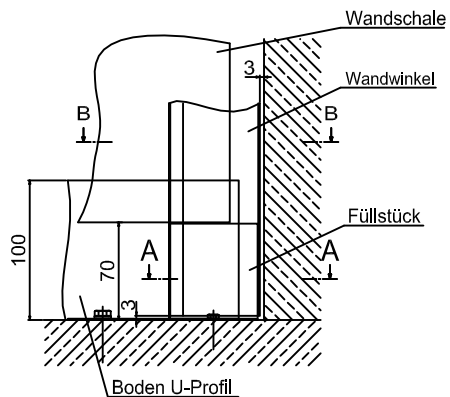

Schnitt A-A

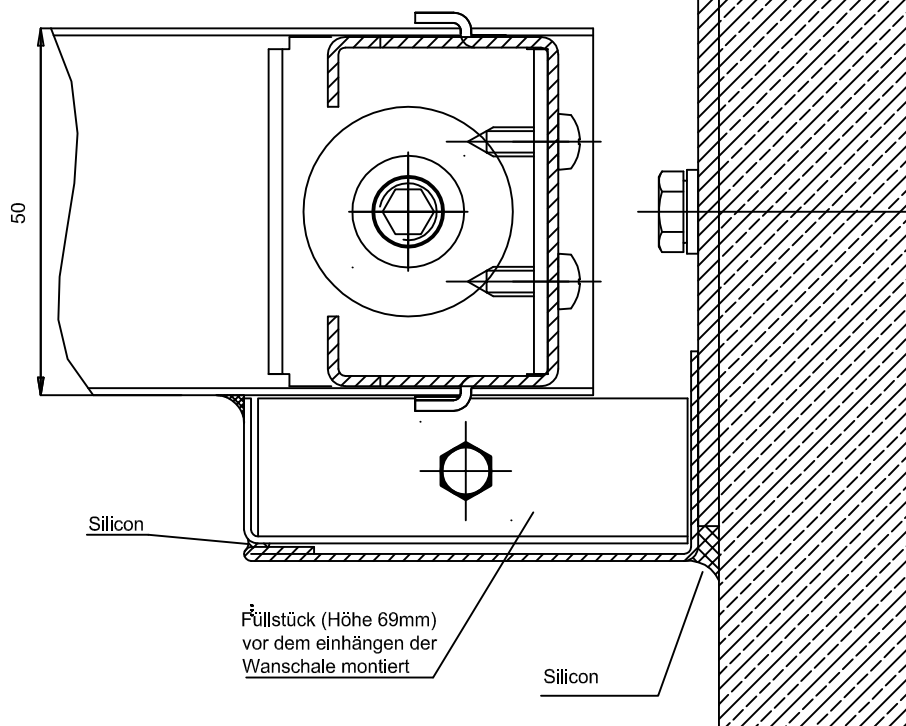

Alle Toleranzen nach DIN ISO 2768 mittel				Material			
This drawing is our literary property and may neither copied nor to be exposed approachable to third persons without our agreement; according to German Copyright Act							
				Datum	Name	Description / Bezeichnung: D 002 Wandanschluss Trennwand halb	
				Gezeichnet	23.07.2014		jk
				Kontrolliert			
				Norm			
				Projekt Nr. PRO_XXX		Z-Nr: VRS_P90_12_0004	
Status	Änderungen	Datum	Name			1 A4	



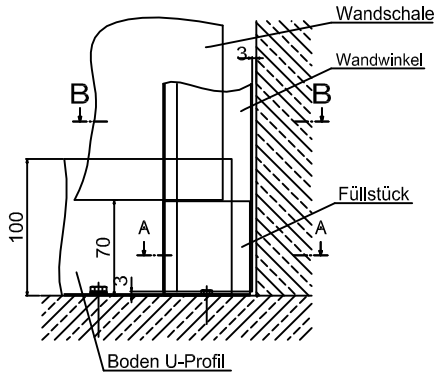

Schnitt B-B

nach dem Einhängen der Wandschale wird der Wandwinkel auf den Blechstreifen geklebt

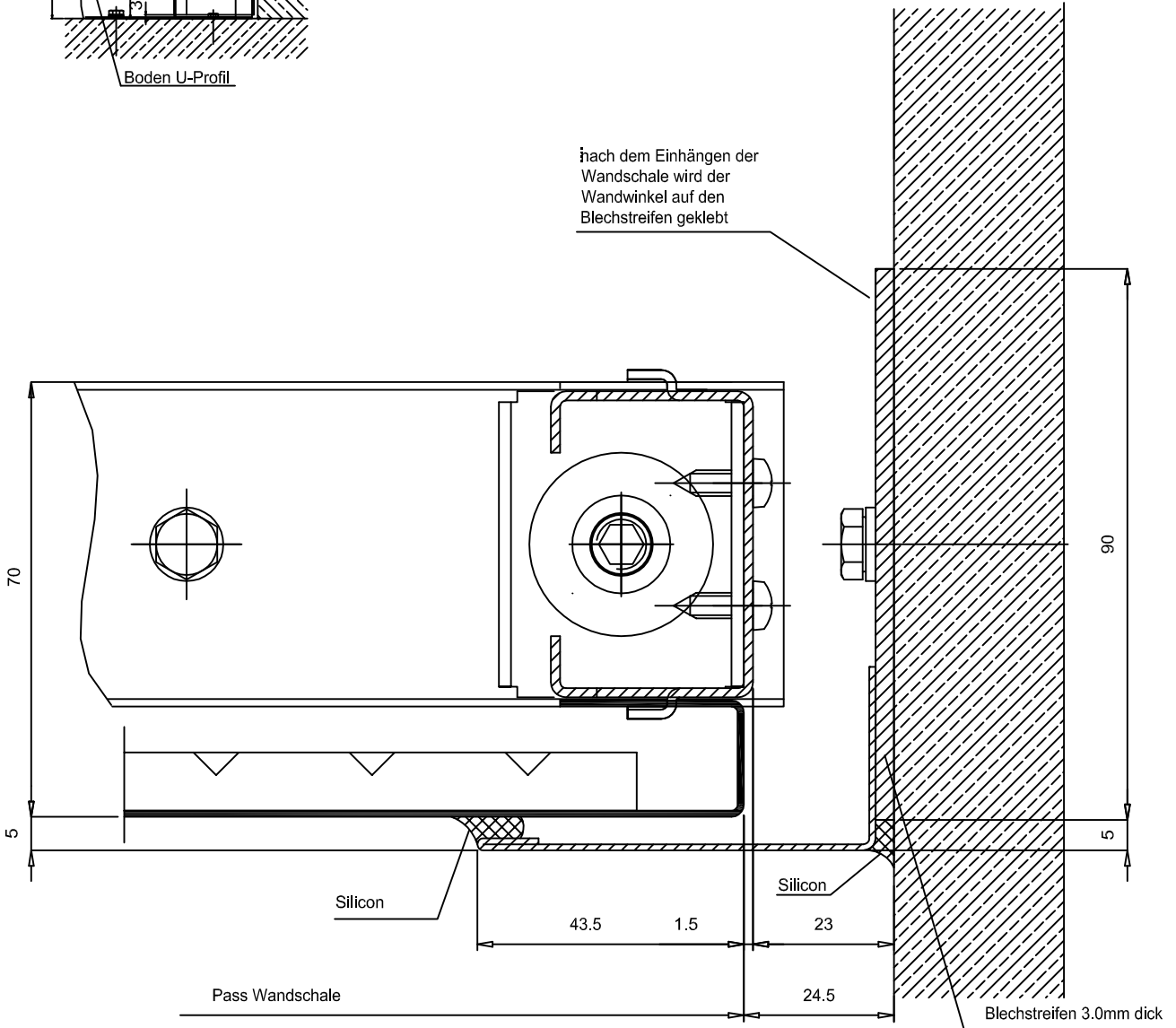

Alle Toleranzen nach DIN ISO 2768 mittel				Material			
This drawing is our literary property and may neither copied nor to be exposed approachable to third persons without our agreement; according to German Copyright Act							
				Datum	Name	Description / Bezeichnung: D 002 A Wandanschluss Trennwand halb	
				Gezeichnet	23.07.2014		jk
				Kontrolliert			
				Norm			
				Projekt Nr. PRO_XXX		Z-Nr: VRS_P90_12_0005	
Status	Änderungen	Datum	Name			1 A4	

Schnitt A-A

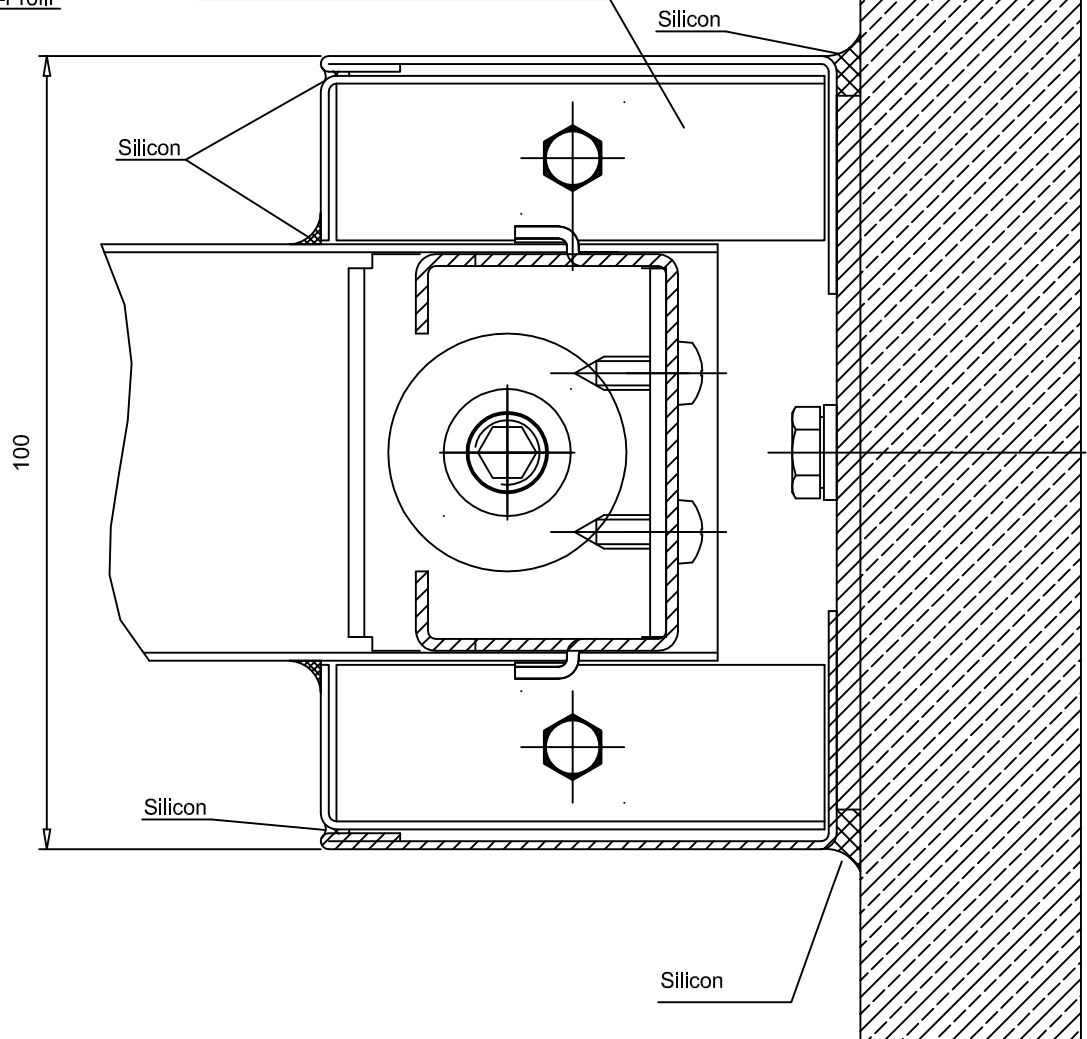
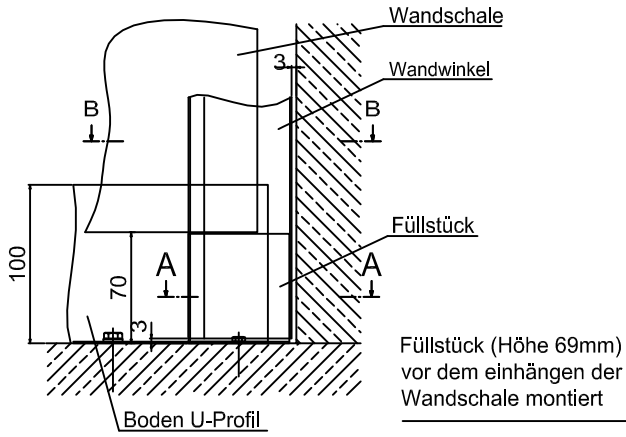

Alle Toleranzen nach DIN ISO 2768 mittel		Material		
This drawing is our literary property and may neither copied nor to be exposed approachable to third persons without our agreement; according to German Copyright Act				
		Datum	Name	Description / Bezeichnung: D 002 B Wandanschluss Trennwand voll
		Gezeichnet	23.07.2014 jk	
		Kontrolliert		
		Norm		
		Projekt Nr. PRO_XXX		Z-Nr: VRS_P90_12_0006
Status	Änderungen	Datum	Name	1 A4

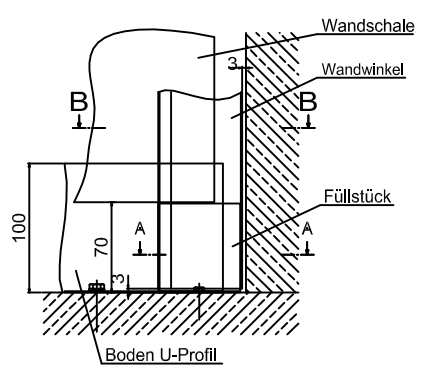

Schnitt B-B

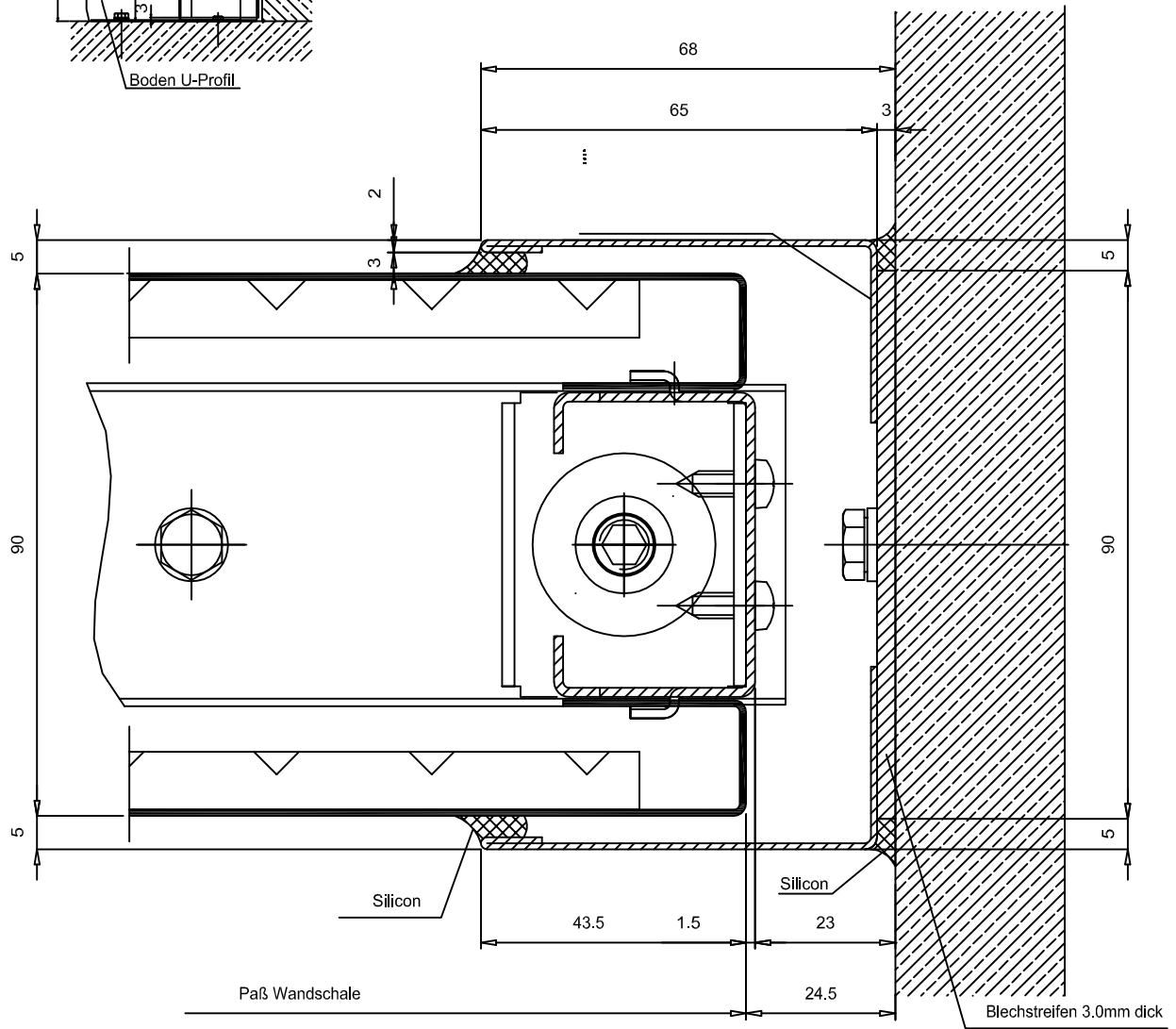

Alle Toleranzen nach DIN ISO 2768 mittel		Material		
This drawing is our literary property and may neither copied nor to be exposed approachable to third persons without our agreement; according to German Copyright Act				
		Datum	Name	Description / Bezeichnung: D 002 C Wandanschluss Trennwand voll
		Gezeichnet	23.07.2014 jk	
		Kontrolliert		
		Norm		
		Projekt Nr. PRO_XXX		Z-Nr: VRS_P90_12_0007
Status	Änderungen	Datum	Name	1 A4

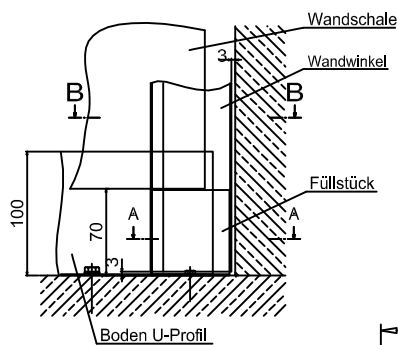

Schnitt B-B

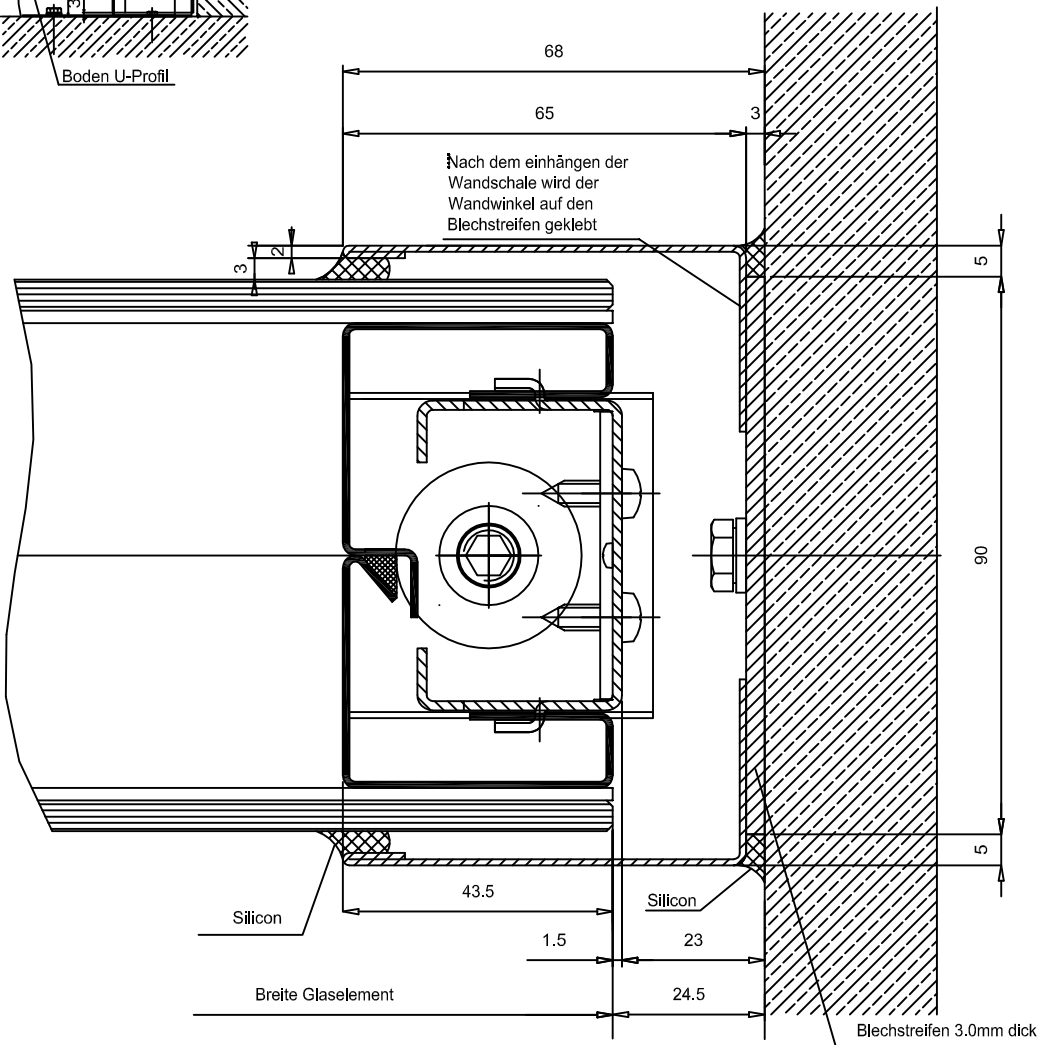

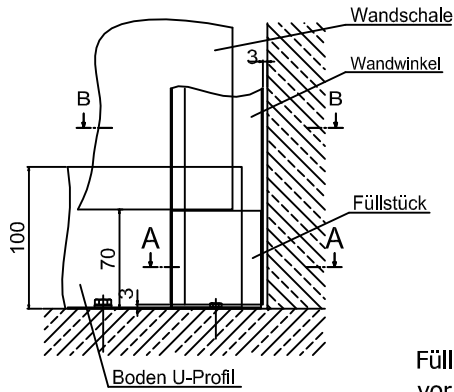

Alle Toleranzen nach DIN ISO 2768 mittel				Material		
This drawing is our literary property and may neither copied nor to be exposed approachable to third persons without our agreement; according to German Copyright Act						
			Datum	Name		Description / Bezeichnung: D 002 D Wandanschluss Glaselement
			Gezeichnet	23.07.2014	jk	
			Kontrolliert			
			Norm			
			Projekt Nr.			Z-Nr: VRS_P90_12_0008
			PRO_XXX			
Status	Änderungen	Datum	Name			1 A4



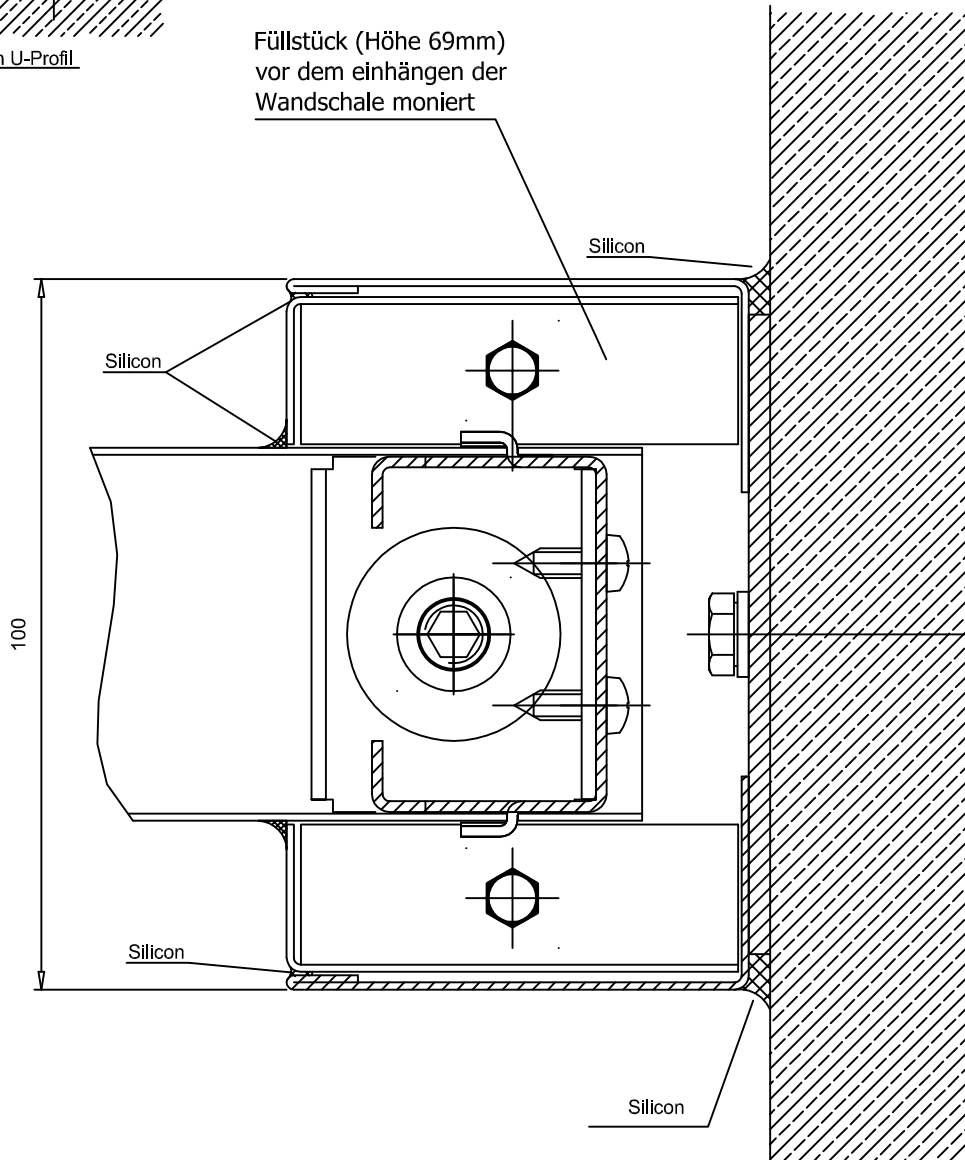

Schnitt A-A

Füllstück (Höhe 69mm)
vor dem einhängen der
Wandschale montiert

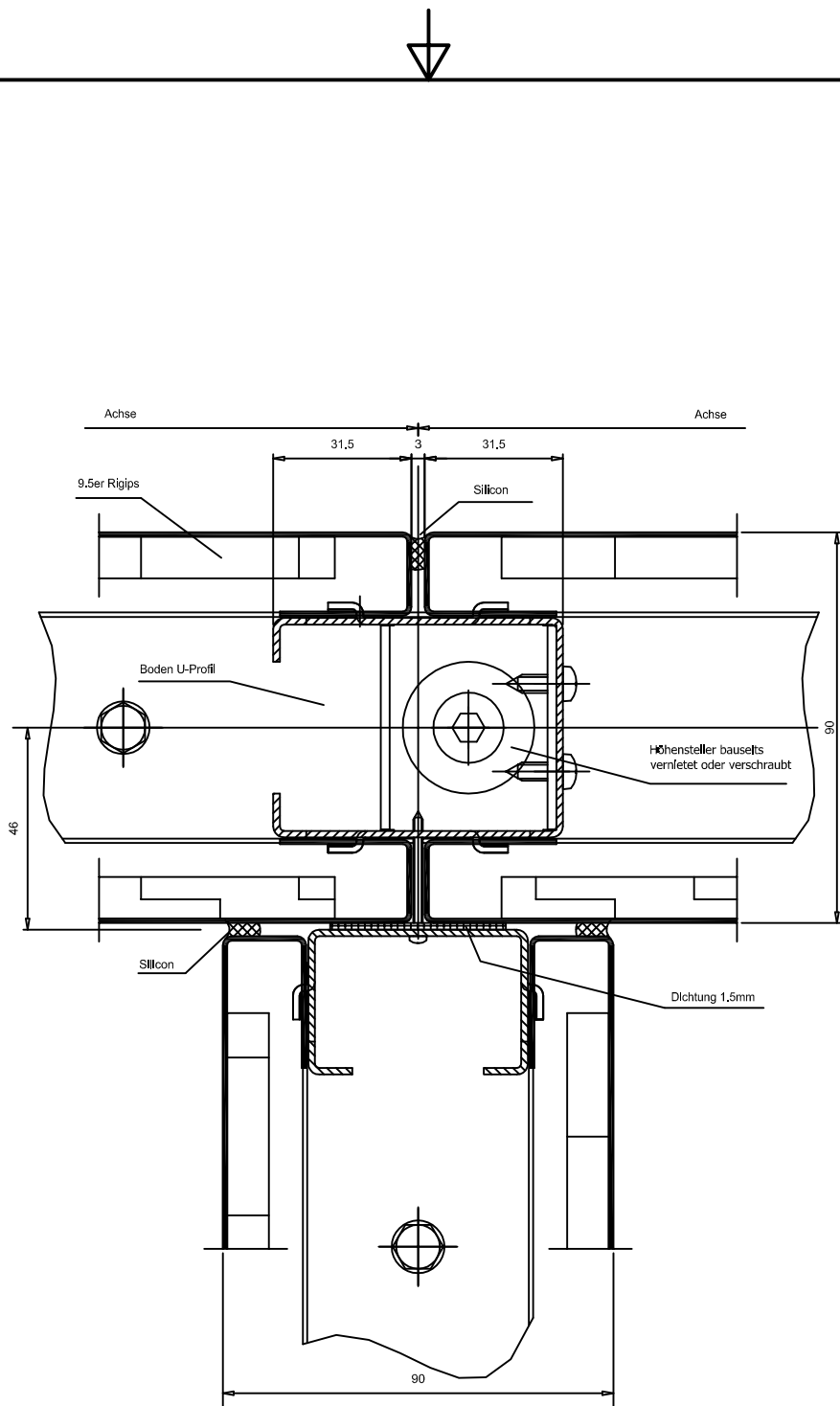

Alle Toleranzen nach DIN ISO 2768 mittel		Material		
<small>This drawing is our literary property and may neither copied nor to be exposed approachable to third persons without our agreement; according to German Copyright Act</small>				
		Datum	Name	Description / Bezeichnung: D 002 E Wandanschluss Glaselement
		Gezeichnet	23.07.2014 jk	
		Kontrolliert		
		Norm		
		Projekt Nr. PRO_XXX		Z-Nr: VRS_P90_12_0009
Status	Änderungen	Datum	Name	1 A4



Alle Toleranzen nach DIN ISO 2768 mittel		Material		
This drawing is our literary property and may neither copied nor to be exposed approachable to third persons without our agreement; according to German Copyright Act				
		Datum	Name	Description / Bezeichnung: D 003 T-Anschluss Voll/Voll/Voll
		Gezeichnet	23.07.2014 jk	
		Kontrolliert		
		Norm		
		Projekt Nr. PRO_XXX		Z-Nr: VRS_P90_12_0010
Status	Änderungen	Datum	Name	1 A4

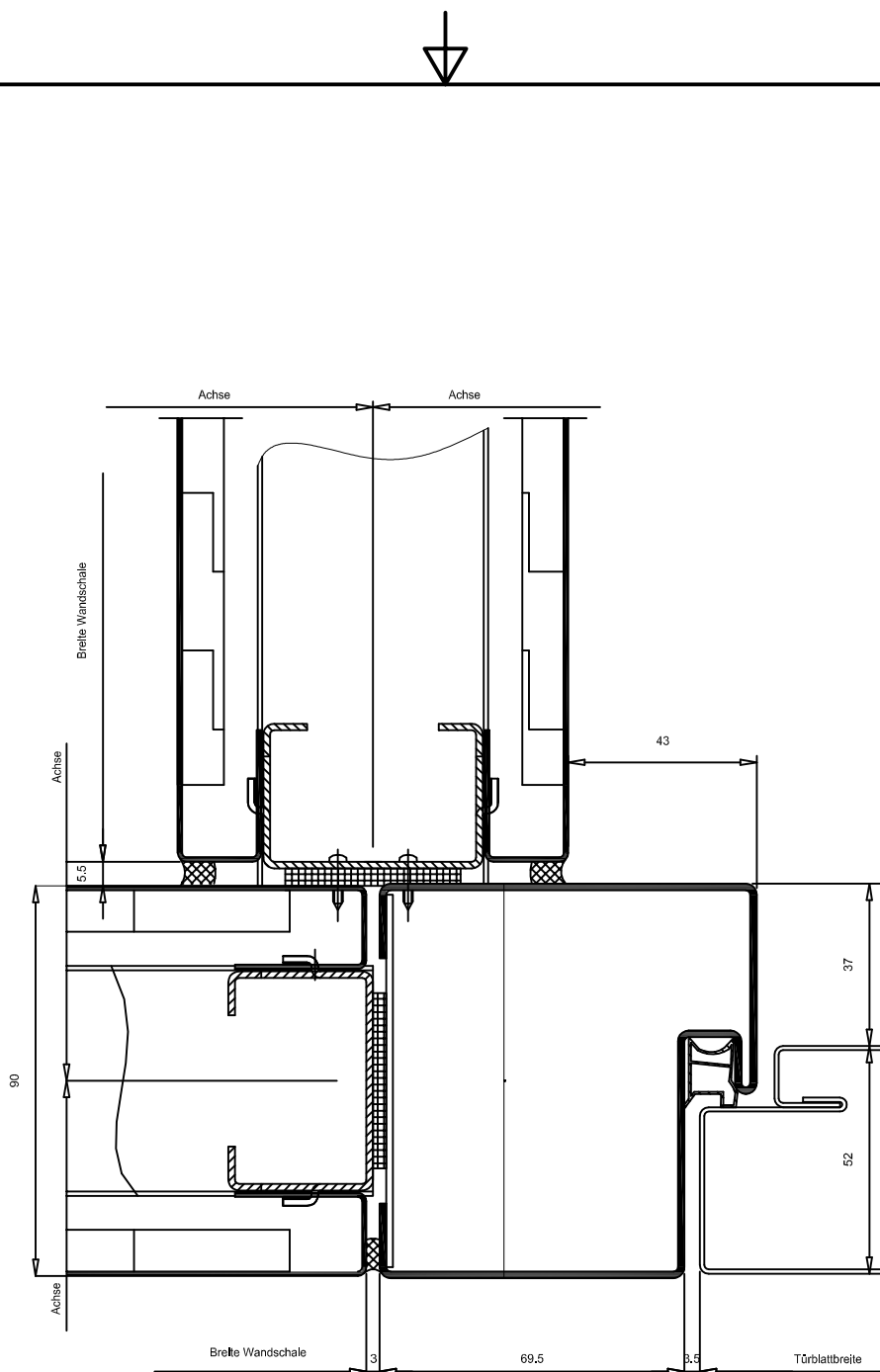

Alle Toleranzen nach DIN ISO 2768 mittel		Material		
This drawing is our literary property and may neither copied nor to be exposed approachable to third persons without our agreement; according to German Copyright Act				
		Datum	Name	Description / Bezeichnung: D 003 A T-Anschluss Trennwand Voll/Voll/Tür
		Gezeichnet	23.07.2014 jk	
		Kontrolliert		
		Norm		
		Projekt Nr. PRO_XXX		Z-Nr: VRS_P90_12_0011
				1
				A4
Status	Änderungen	Datum	Name	

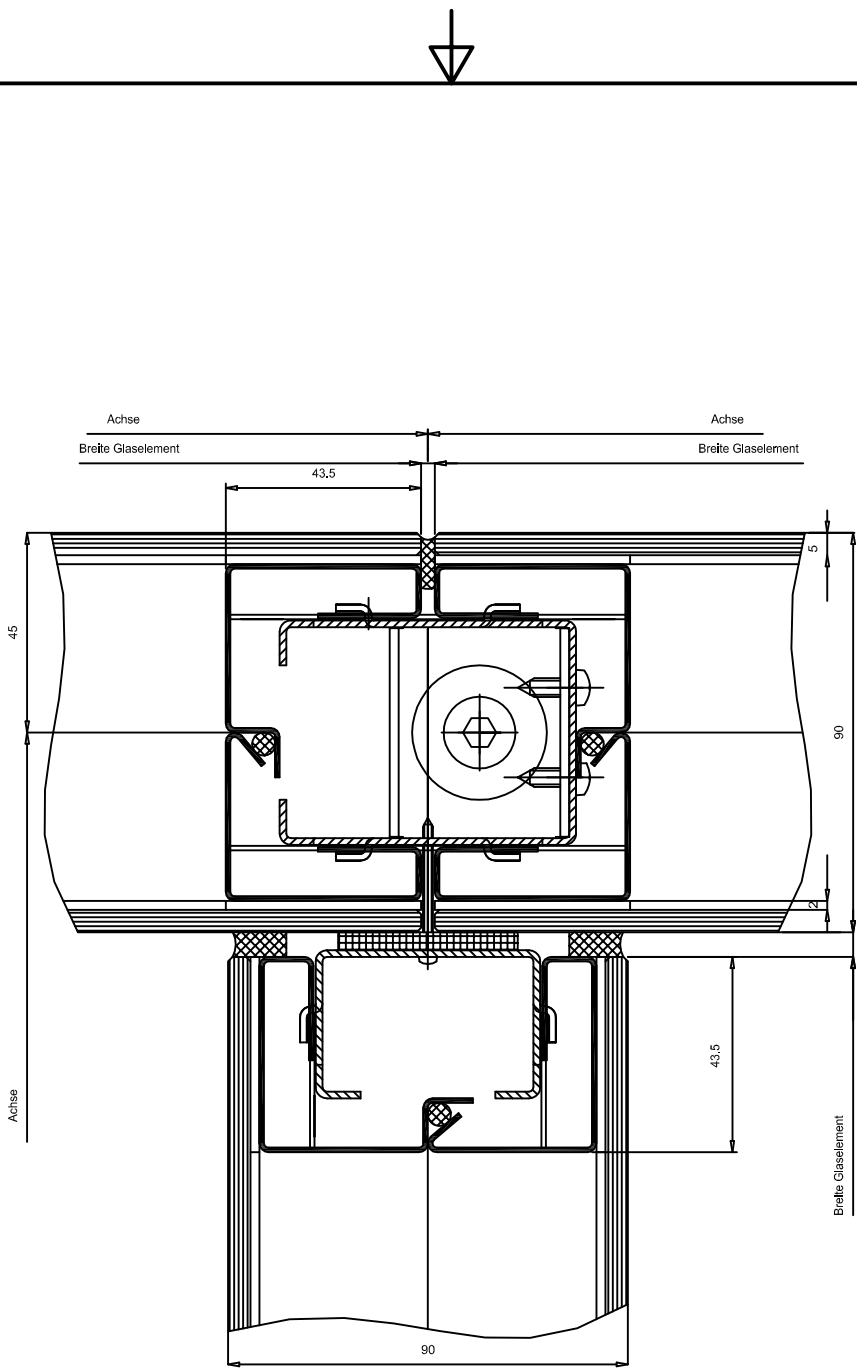

Alle Toleranzen nach DIN ISO 2768 mittel				Material		
This drawing is our literary property and may neither copied nor to be exposed approachable to third persons without our agreement; according to German Copyright Act						
				Datum	Name	Description / Bezeichnung: D 003 B T-Anschluss Trennwand Glas/Glas/Glas
				Gezeichnet	24.07.2014 jk	
				Kontrolliert		
				Norm		
				Projekt Nr. PRO_XXX		Z-Nr: VRS_P90_12_0012
						1
						A4
Status	Änderungen	Datum	Name			

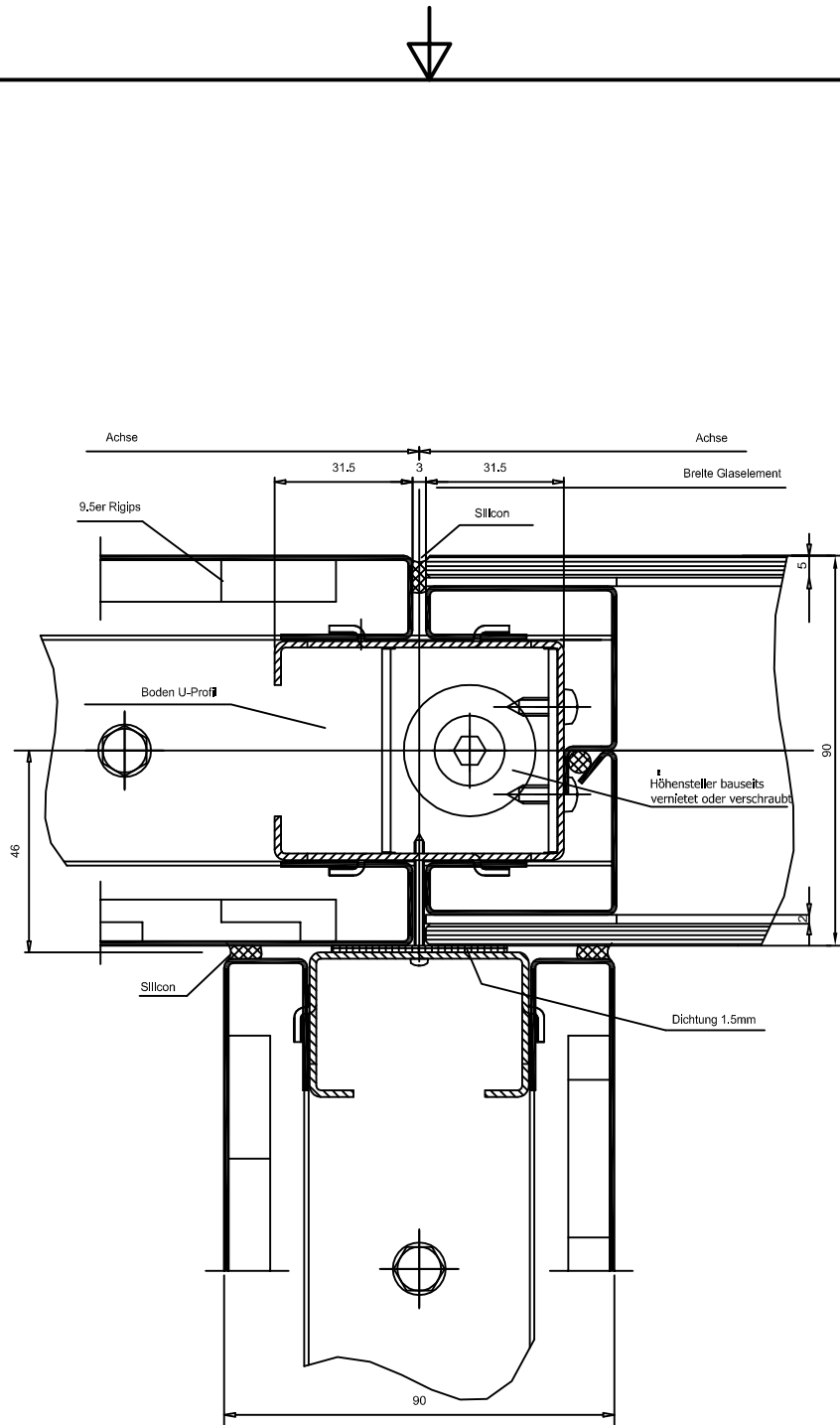

Alle Toleranzen nach DIN ISO 2768 mittel		Material		
This drawing is our literary property and may neither copied nor to be exposed approachable to third persons without our agreement; according to German Copyright Act				
		Datum	Name	Description / Bezeichnung: D 003 C T-Anschluss Trennwand Voll/Glas/Voll
		Gezeichnet	24.07.2014 jk	
		Kontrolliert		
		Norm		
		Projekt Nr. PRO_XXX		Z-Nr: VRS_P90_12_0013
Status	Änderungen	Datum	Name	1 A4

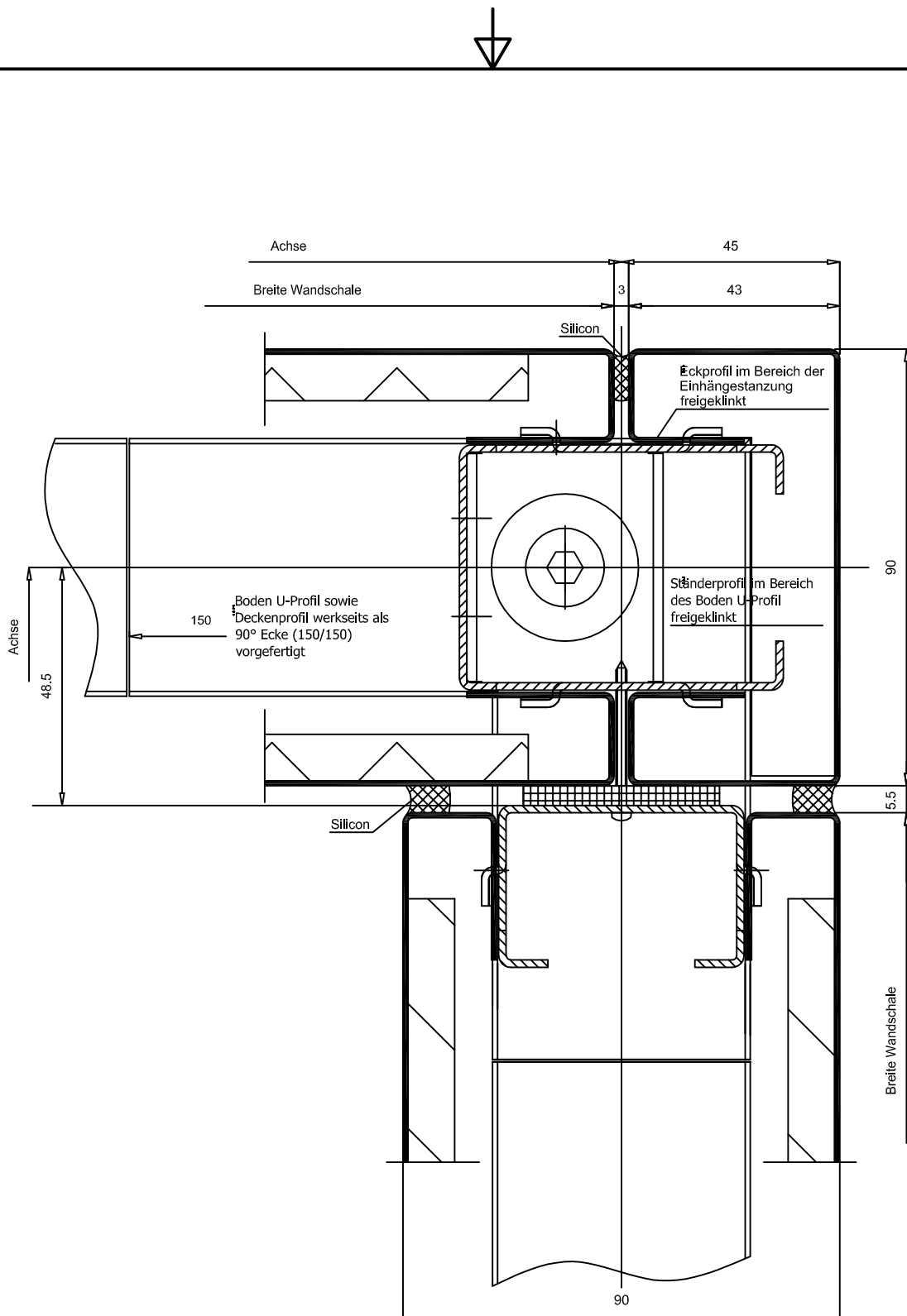

Alle Toleranzen nach DIN ISO 2768 mittel		Material		
This drawing is our literary property and may neither copied nor to be exposed approachable to third persons without our agreement; according to German Copyright Act				
		Datum	Name	Description / Bezeichnung: D 004 Eckausbildung Trennwand Voll/Voll
		Gezeichnet	24.07.2014 jk	
		Kontrolliert		
		Norm		
		Projekt Nr. PRO_XXX		Z-Nr: VRS_P90_12_0014
				1
				A4
Status	Änderungen	Datum	Name	

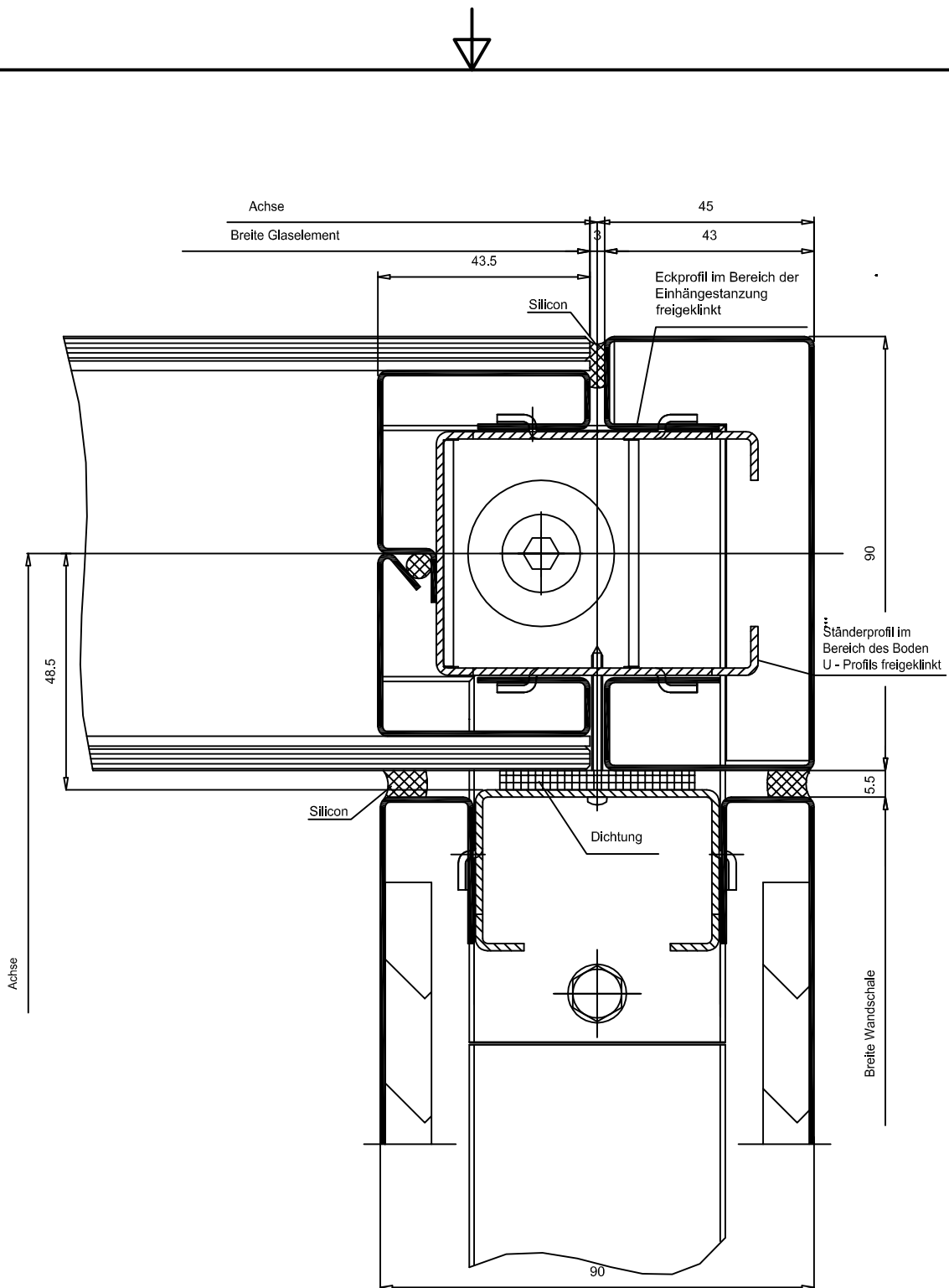

Alle Toleranzen nach DIN ISO 2768 mittel				Material			
This drawing is our literary property and may neither copied nor to be exposed approachable to third persons without our agreement; according to German Copyright Act							
				Datum	Name	Description / Bezeichnung: D 004 A Eckausbildung Trennwand Voll/Verglast	
				Gezeichnet	24.07.2014		jk
				Kontrolliert			
				Norm			
				Projekt Nr. PRO_XXX		Z-Nr: VRS_P90_12_0015	
Status	Änderungen	Datum	Name			1 A4	

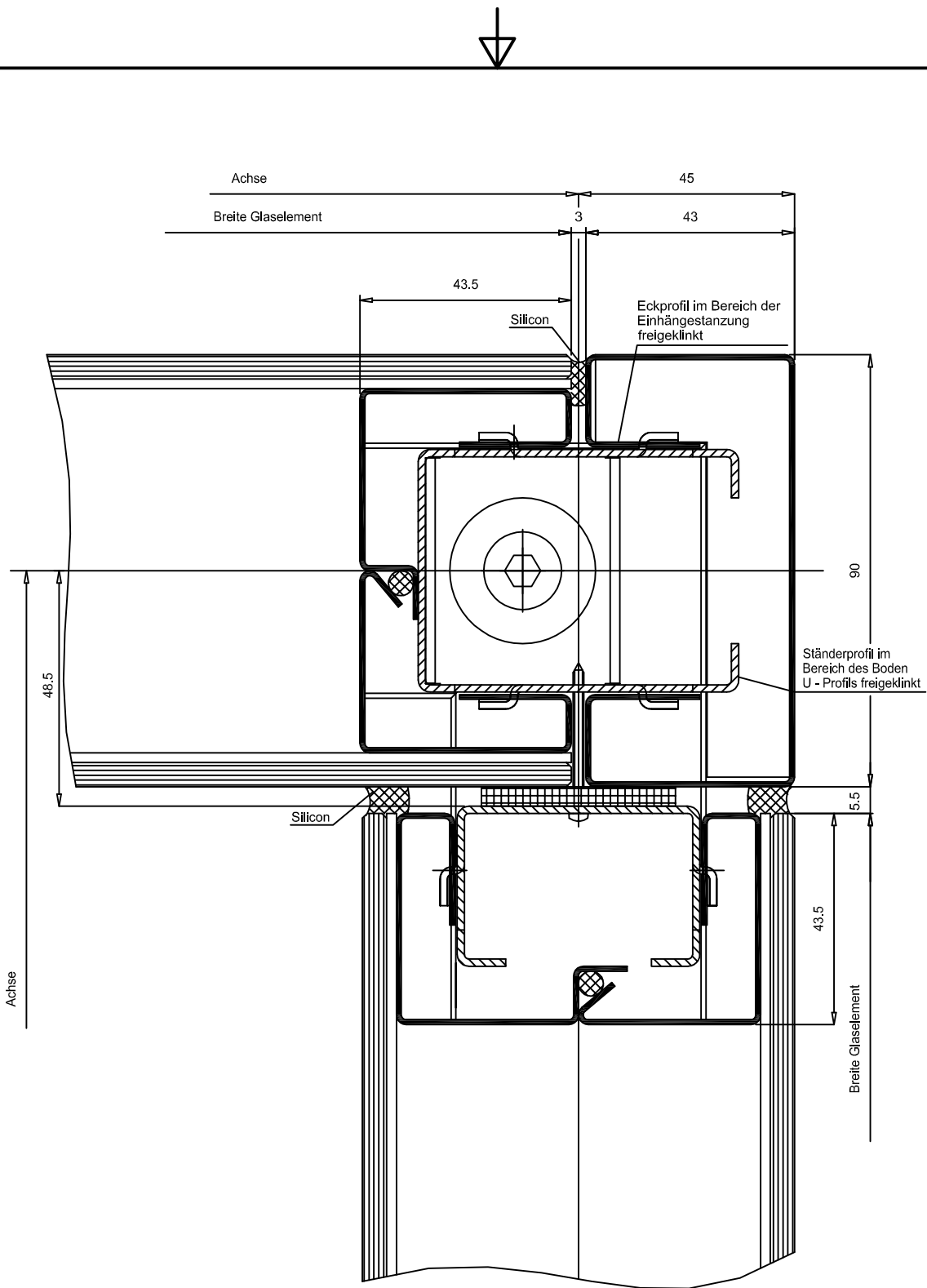

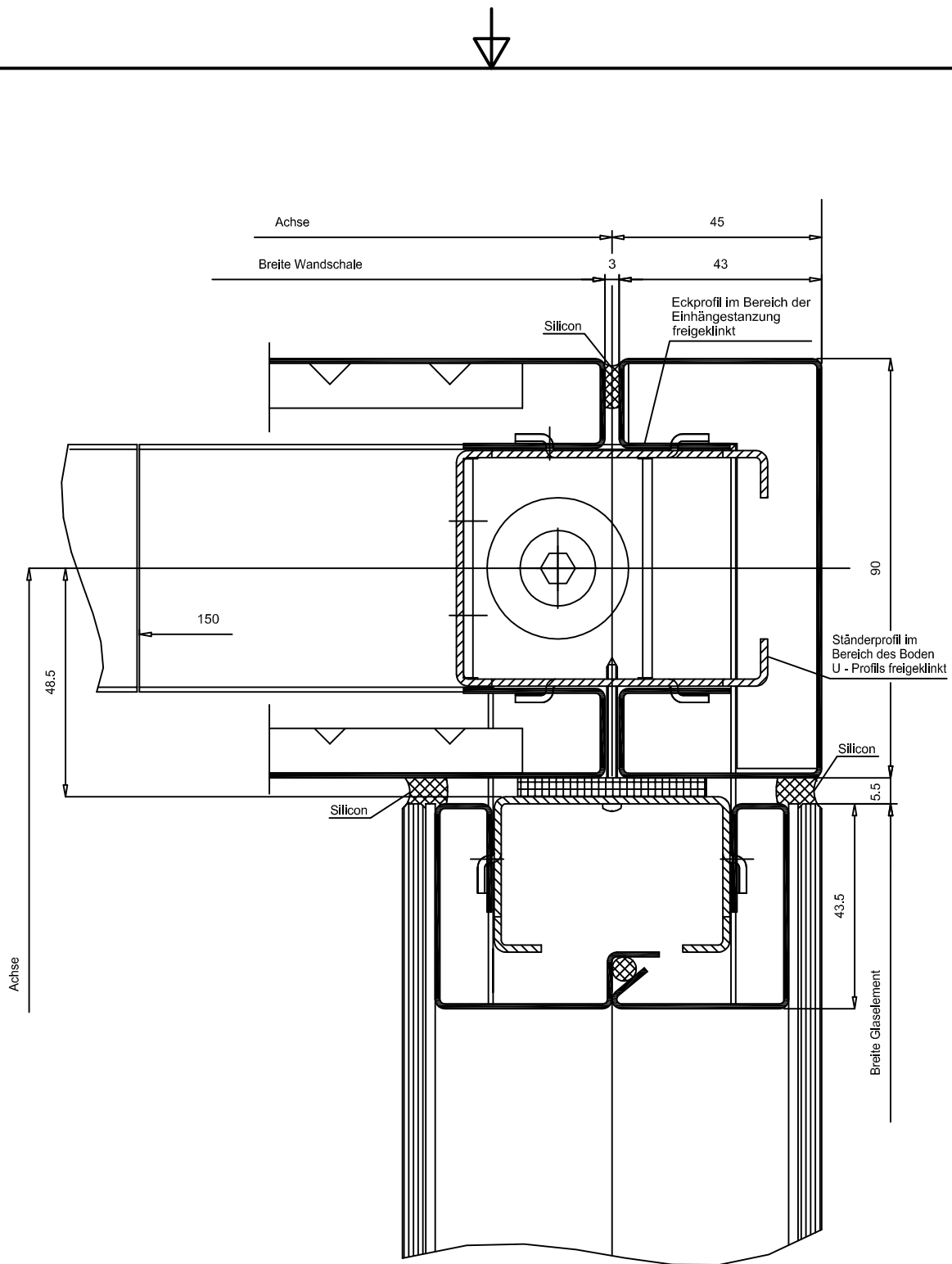

Alle Toleranzen nach DIN ISO 2768 mittel				Material		
This drawing is our literary property and may neither copied nor to be exposed approachable to third persons without our agreement; according to German Copyright Act						
				Datum	Name	Description / Bezeichnung: D 004 B Eckausbildung Trennwand Verglast/Verglast
				Gezeichnet	24.07.2014 jk	
				Kontrolliert		
				Norm		
				Projekt Nr.		Z-Nr: VRS_P90_12_0016
				PRO_XXX		
Status	Änderungen	Datum	Name			1 A4

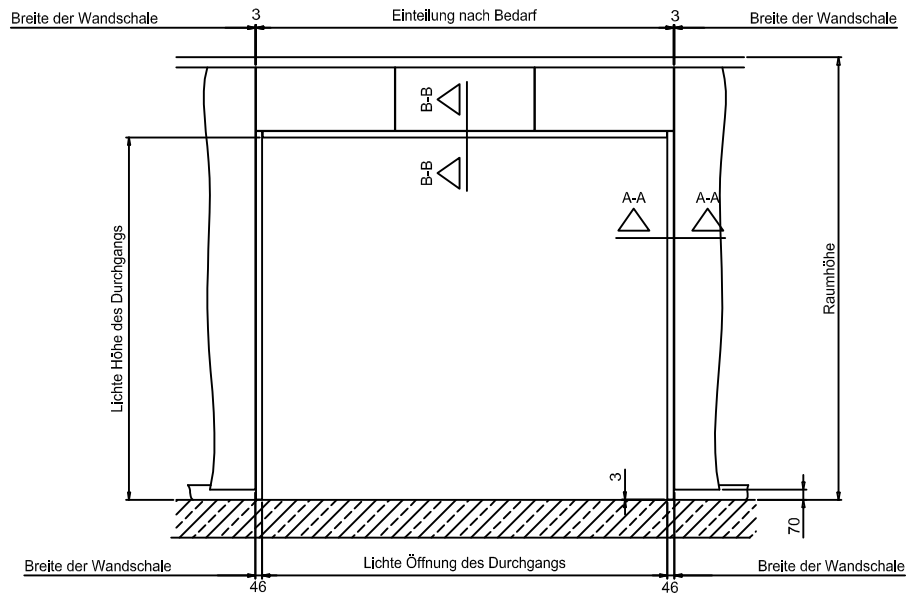
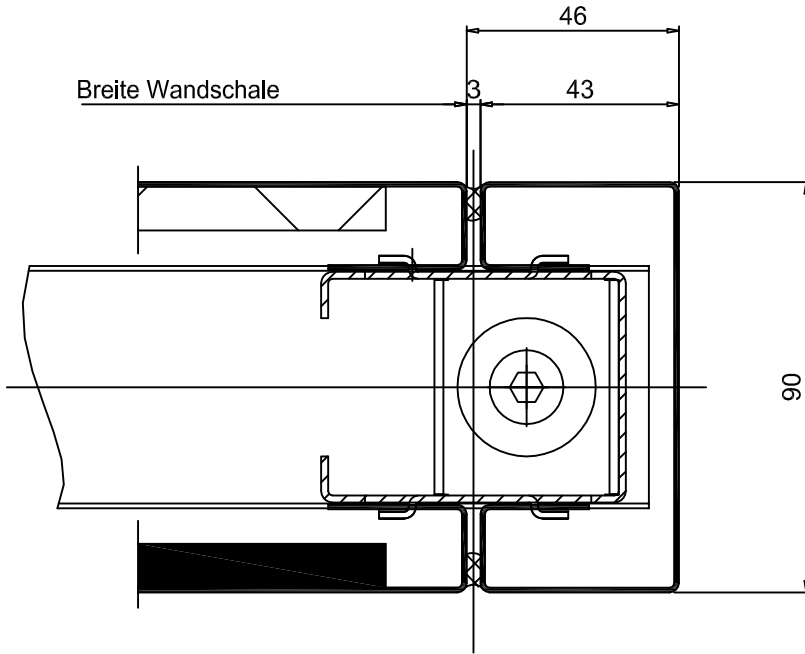

Alle Toleranzen nach DIN ISO 2768 mittel		Material		
This drawing is our literary property and may neither copied nor to be exposed approachable to third persons without our agreement; according to German Copyright Act				
		Datum	Name	Description / Bezeichnung: D 004 C Eckausbildung Trennwand Verglast/Voll
		Gezeichnet	24.07.2014 jk	
		Kontrolliert		
		Norm		
		Projekt Nr. PRO_XXX		Z-Nr: VRS_P90_12_0017
Status	Änderungen	Datum	Name	1 A4

Schnitt A-A



Alle Toleranzen nach DIN ISO 2768 mittel				Material		
This drawing is our literary property and may neither copied nor to be exposed approachable to third persons without our agreement; according to German Copyright Act						
				Datum	Name	Description / Bezeichnung: D 010 Durchgangszarge
				Gezeichnet	25.07.2014 jk	
				Kontrolliert		
				Norm		
				Projekt Nr. PRO_XXX		Z-Nr: VRS_P90_12_0018
						1
						A4
Status	Änderungen	Datum	Name			



Schnitt A-A

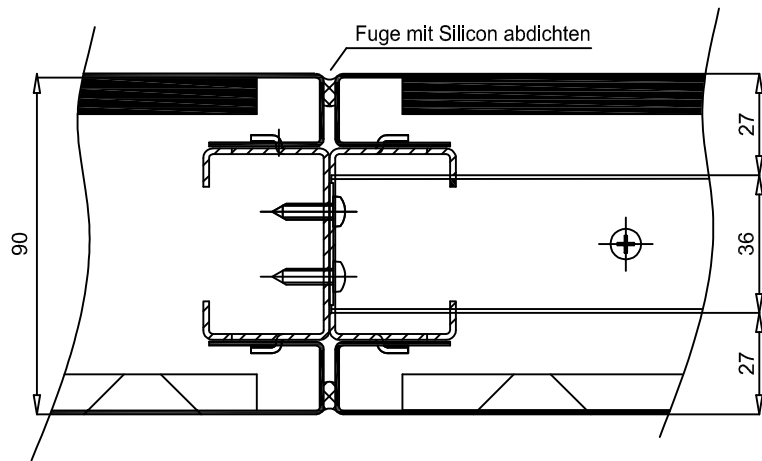

Schnitt B-B

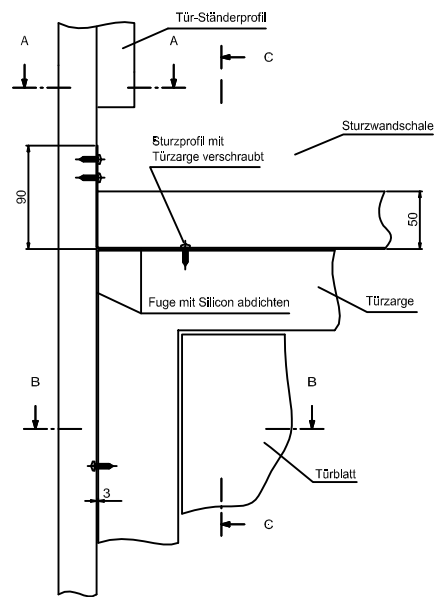
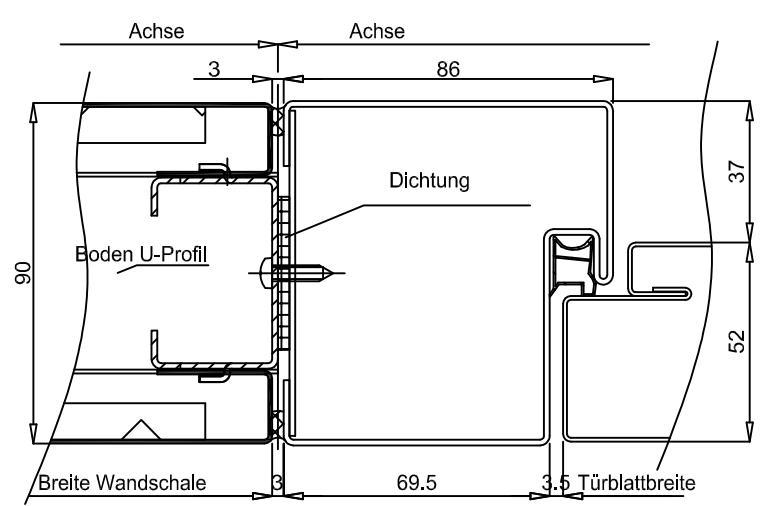



Alle Toleranzen nach DIN ISO 2768 mittel		Material		
This drawing is our literary property and may neither copied nor to be exposed approachable to third persons without our agreement; according to German Copyright Act				
		Datum	Name	Description / Bezeichnung: D 012 Türanschluss an Vollwand
		Gezeichnet	25.07.2014 jk	
		Kontrolliert		
		Norm		
		Projekt Nr. PRO_XXX		Z-Nr: VRS_P90_12_0019
Status	Änderungen	Datum	Name	1
				A4

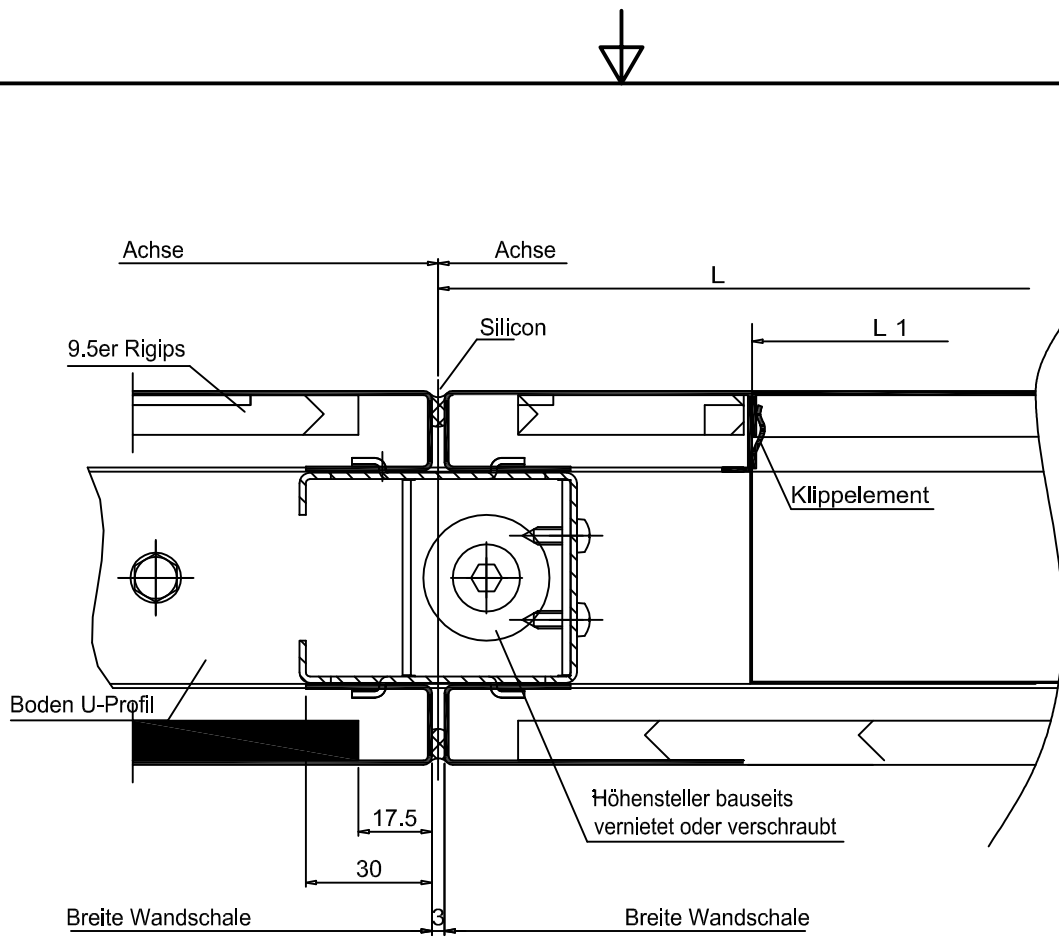

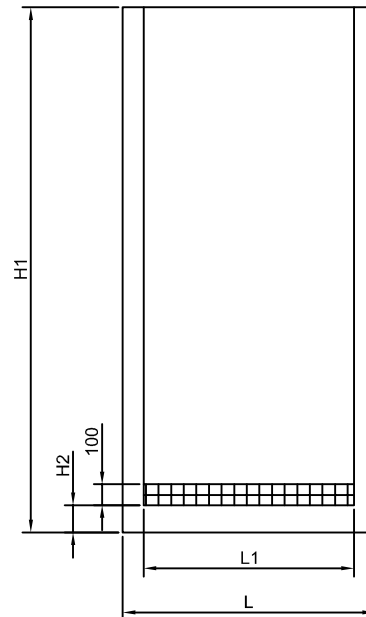

Ansicht



Alle Toleranzen nach DIN ISO 2768 mittel				Material			
This drawing is our literary property and may neither copied nor to be exposed approachable to third persons without our agreement; according to German Copyright Act							
				Datum	Name	Description / Bezeichnung: D 013 Rücklaufschacht integriert	
				Gezeichnet	25.07.2014		jk
				Kontrolliert			
				Norm			
				Projekt Nr. PRO_XXX		Z-Nr: VRS_P90_12_0020	
						1	
						A4	
Status	Änderungen	Datum	Name				

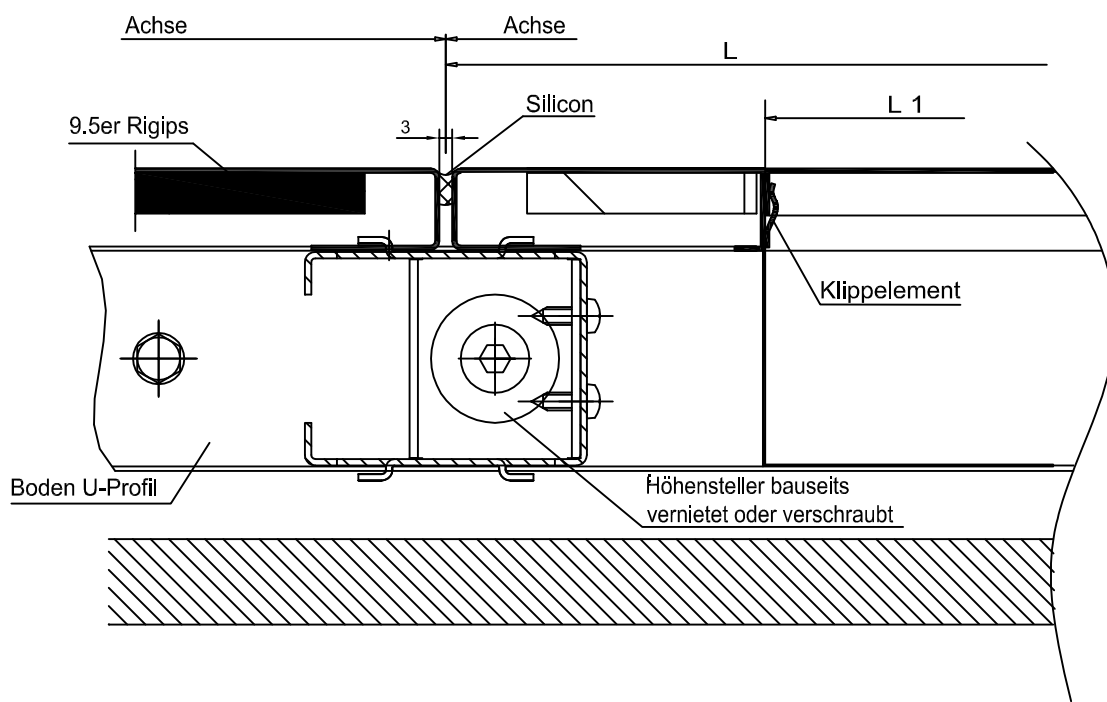

Ansicht

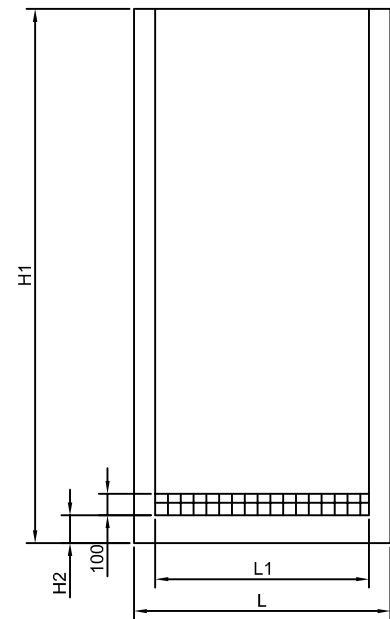

Alle Toleranzen nach DIN ISO 2768 mittel				Material		
This drawing is our literary property and may neither copied nor to be exposed approachable to third persons without our agreement; according to German Copyright Act						
				Datum	Name	Description / Bezeichnung: D 013 A Rückluftschtacht integriert mit Wandverkleidung
				Gezeichnet	25.07.2014 jk	
				Kontrolliert		
				Norm		
				Projekt Nr. PRO_XXX		Z-Nr: VRS_P90_12_0021
Status	Änderungen	Datum	Name			1 A4

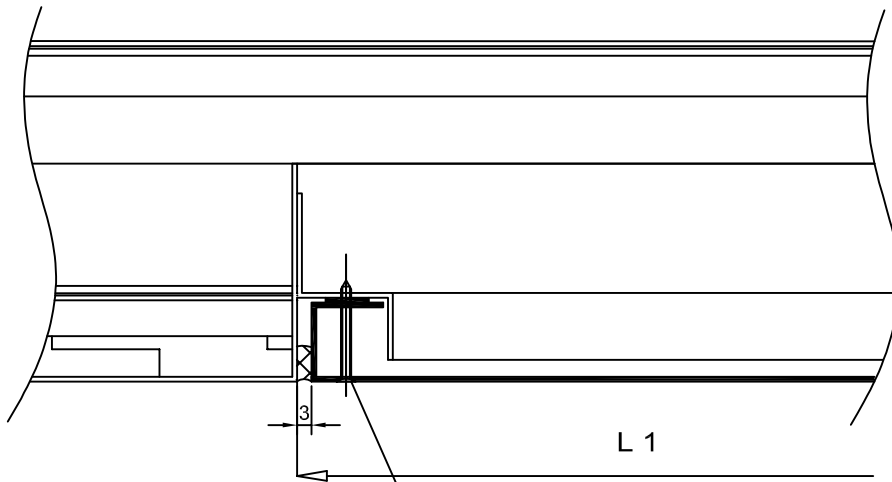

4 Befestigungsschrauben

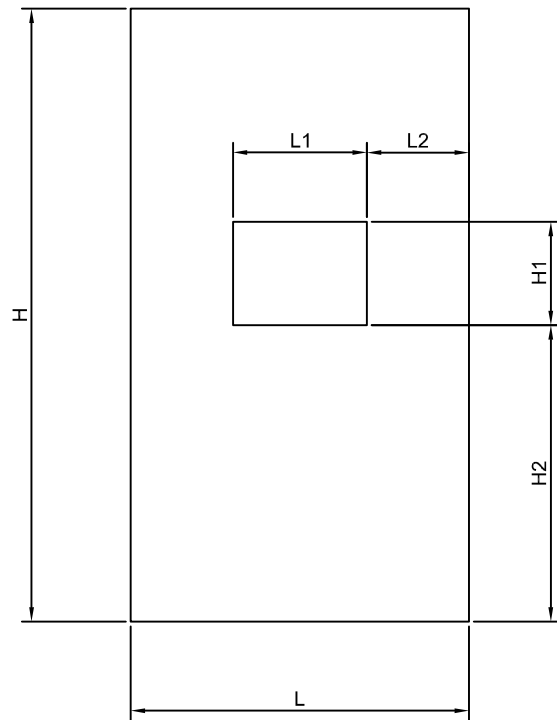

Alle Toleranzen nach DIN ISO 2768 mittel				Material		
This drawing is our literary property and may neither copied nor to be exposed approachable to third persons without our agreement; according to German Copyright Act						
				Datum	Name	Description / Bezeichnung: D 013 B Installation Trennwand halb
				Gezeichnet	25.07.2014 jk	
				Kontrolliert		
				Norm		
				Projekt Nr. PRO_XXX		Z-Nr: VRS_P90_12_0022
						1
						A4
Status	Änderungen	Datum	Name			

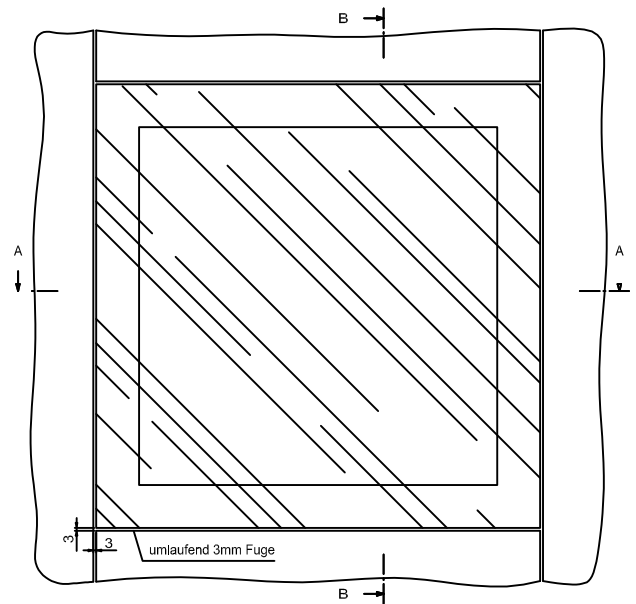

Schnitt A-A

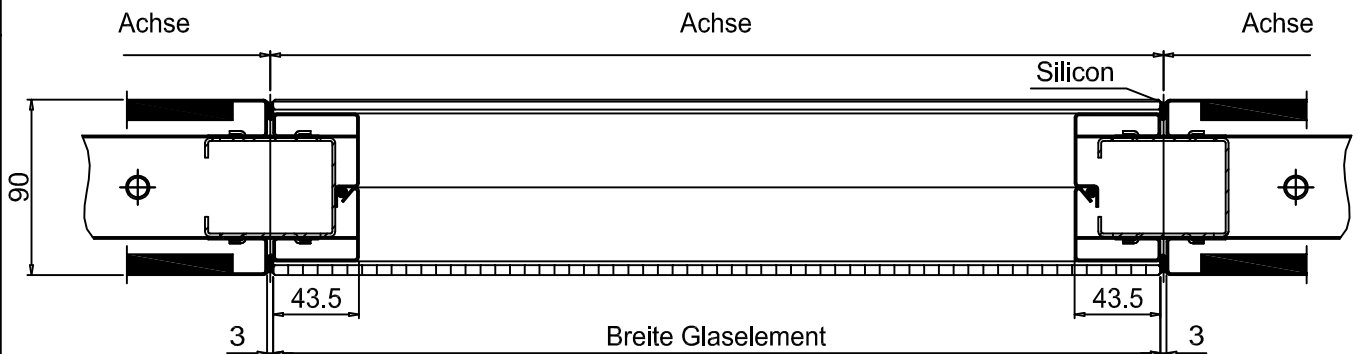

Alle Toleranzen nach DIN ISO 2768 mittel				Material		
This drawing is our literary property and may neither copied nor to be exposed approachable to third persons without our agreement; according to German Copyright Act						
				Datum	Name	Description / Bezeichnung: D 014 A Trennwandverglasung
				Gezeichnet	25.07.2014 jk	
				Kontrolliert		
				Norm		
				Projekt Nr. PRO_XXX		Z-Nr: VRS_P90_12_0023
						1
						A4
Status	Änderungen	Datum	Name			



TECHNICAL DATA SHEET

WALL TYPE P98

Wall system with suspended steel sheet lagging

Surface of beam / extrusion	Aluminium, blank
Surface of panels	Powder-coated, gloss level 30, backside primed 5 µm
Panels	Steel sheet panel 1 mm
Standard grid	1200 mm
Standard color	RAL 9010
Filling	none or on request
Wall height	2500 mm to 4500 mm, depends on grid size
Wall thickness	98 mm

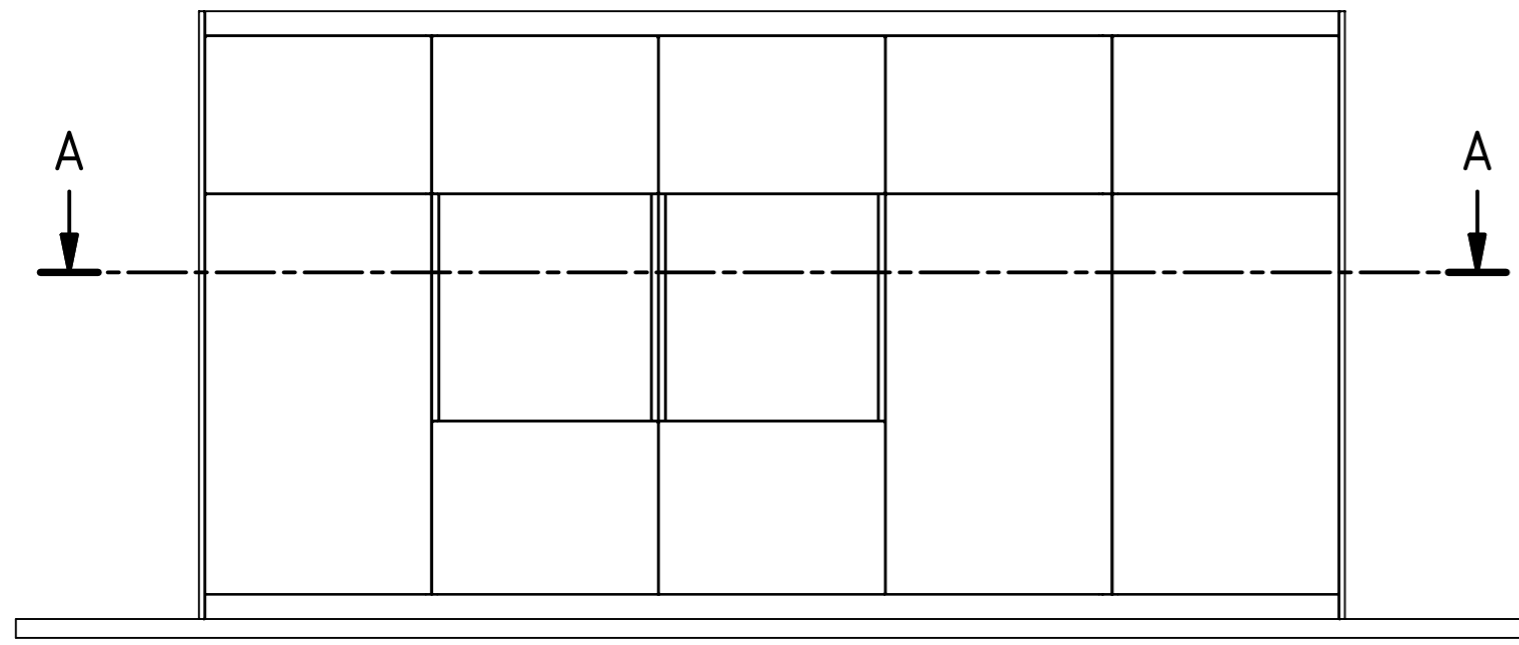

A-A

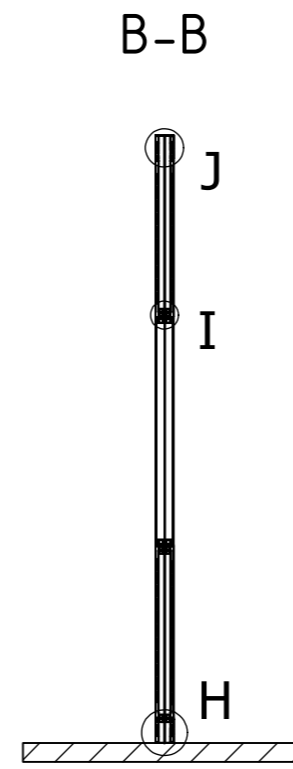

B-B

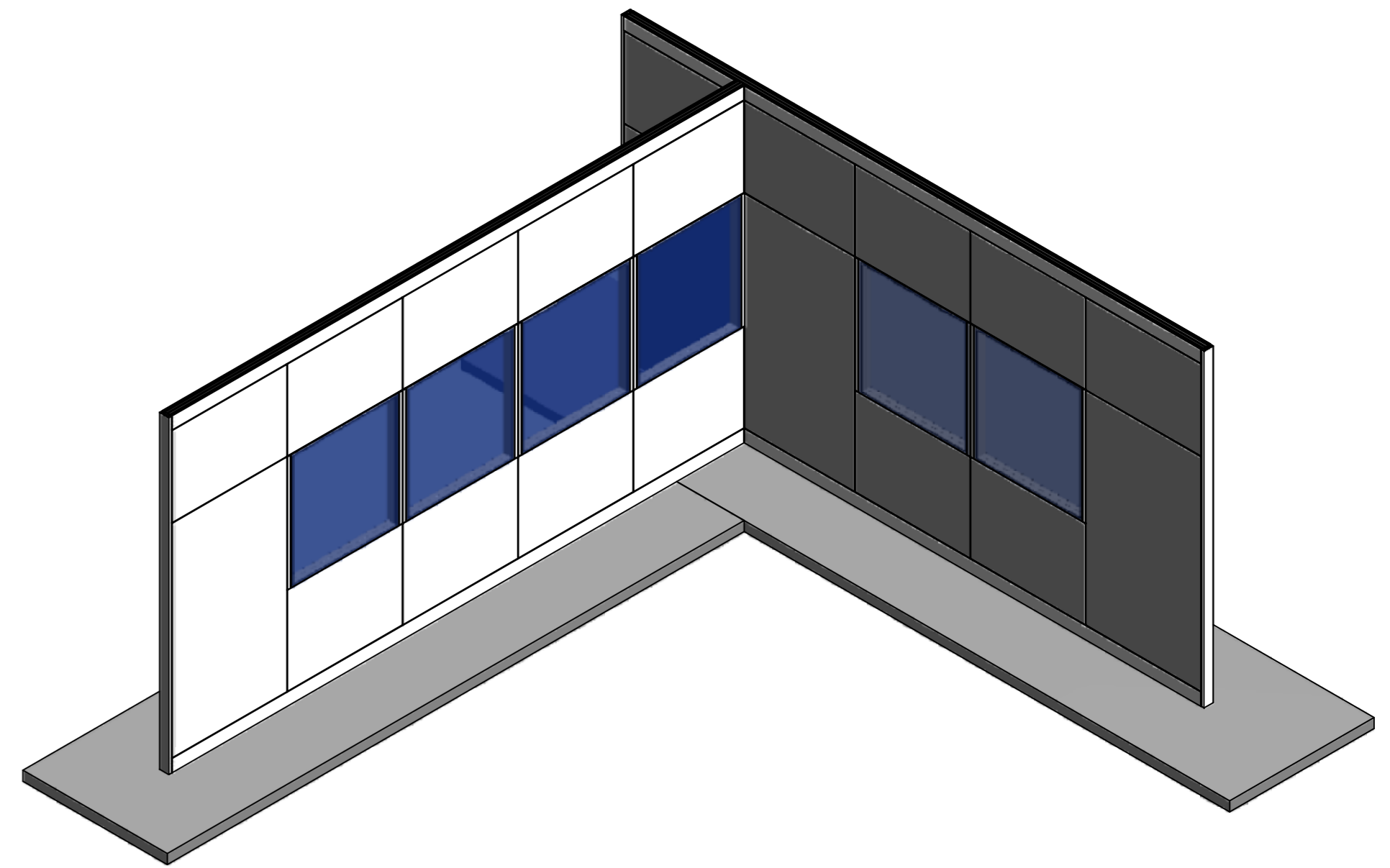
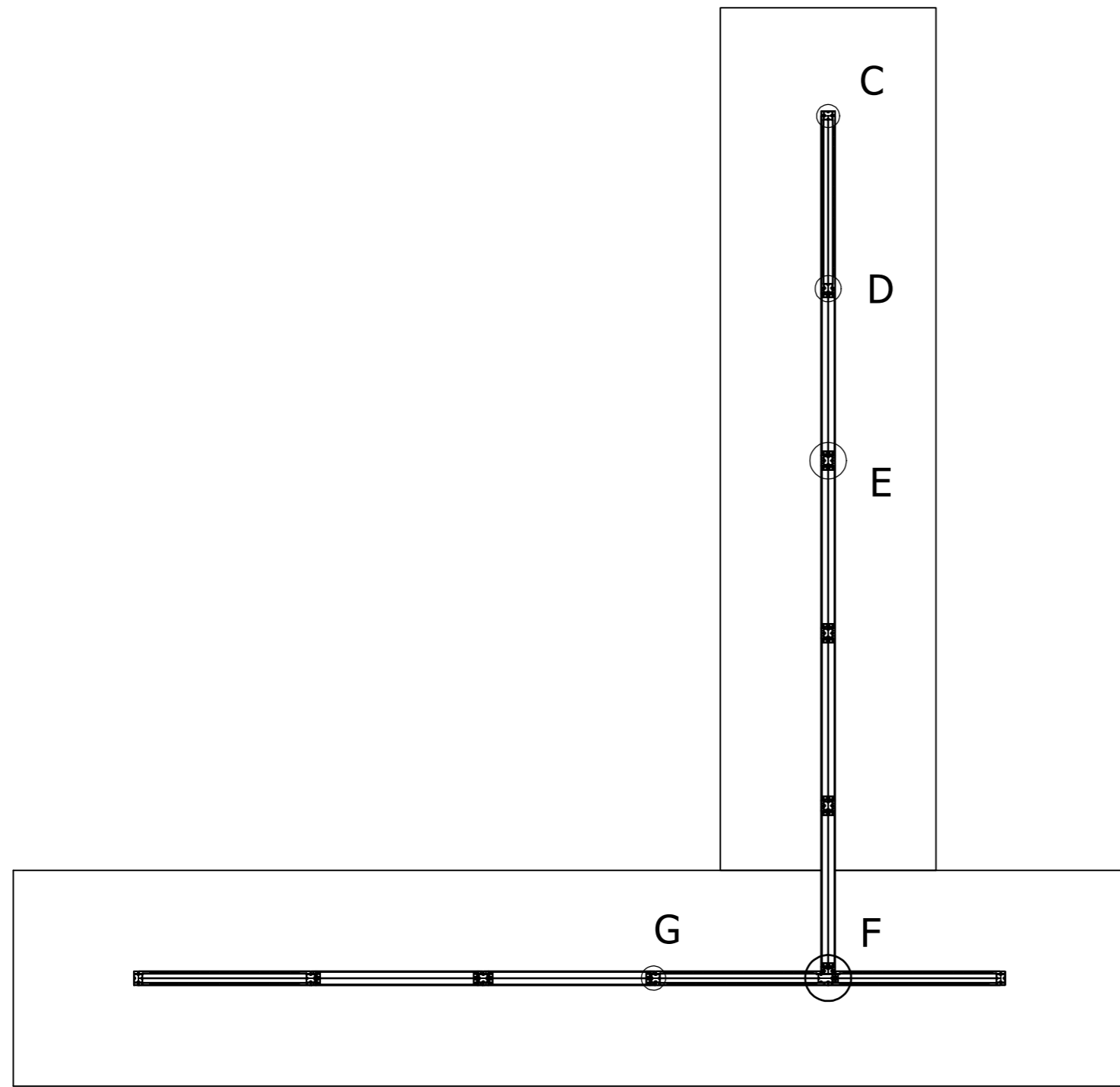
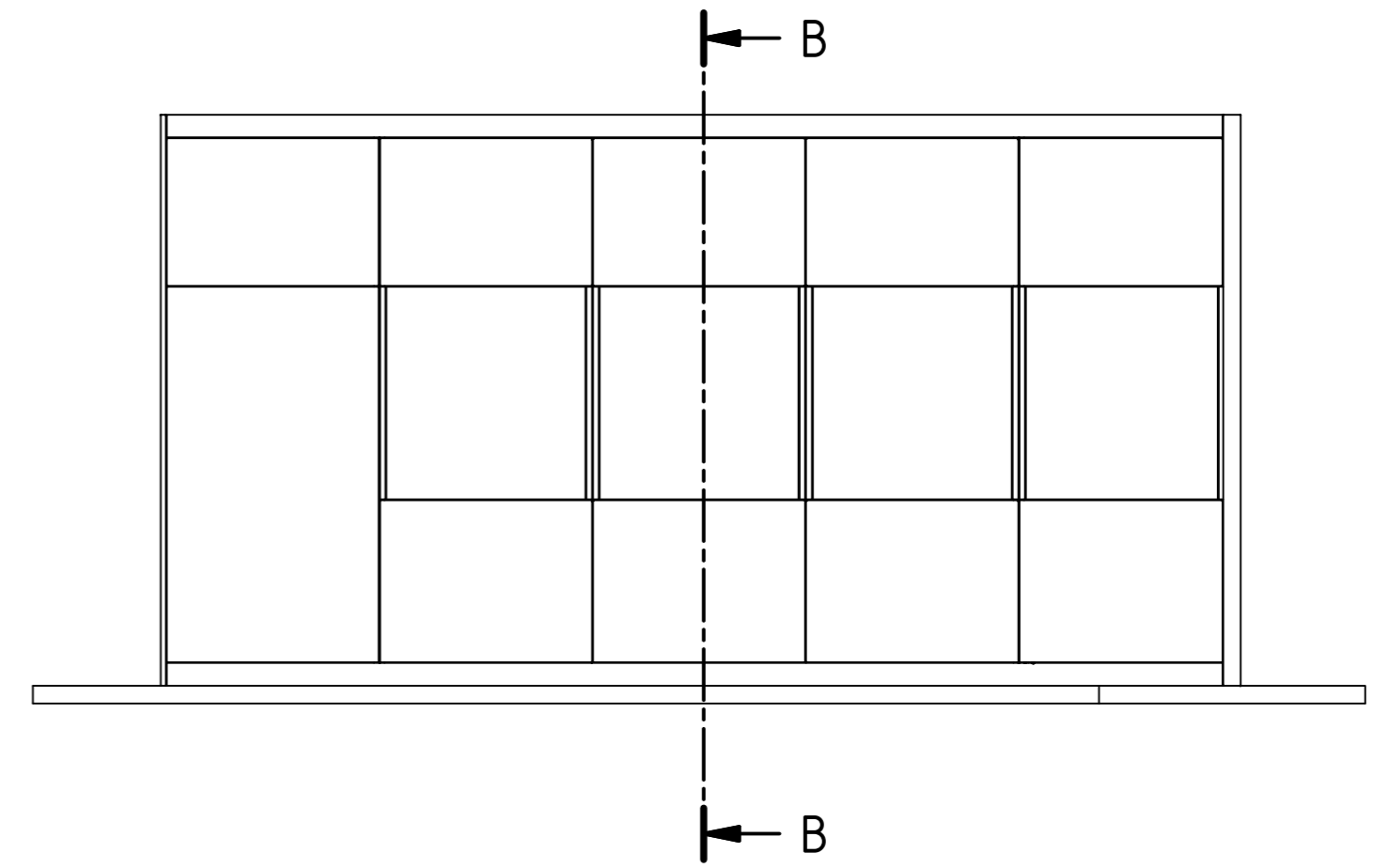

Alle Toleranzen nach DIN ISO 2768 mittel		Material		
<small>This drawing is our literary property and may neither be copied nor to be exposed approachable to third persons without our agreement; according to German Copyright Act</small>				
Gezeichnet	Datum	Name	Bezeichnung:	
Kontrolliert	31.07.2014	JK	Wandsystem OCV 98 mm	
Norm			Z-Nr: VRS_P98_10_0000	
Projekt Nr.			1	
Status	Änderungen	Datum	Name	A2

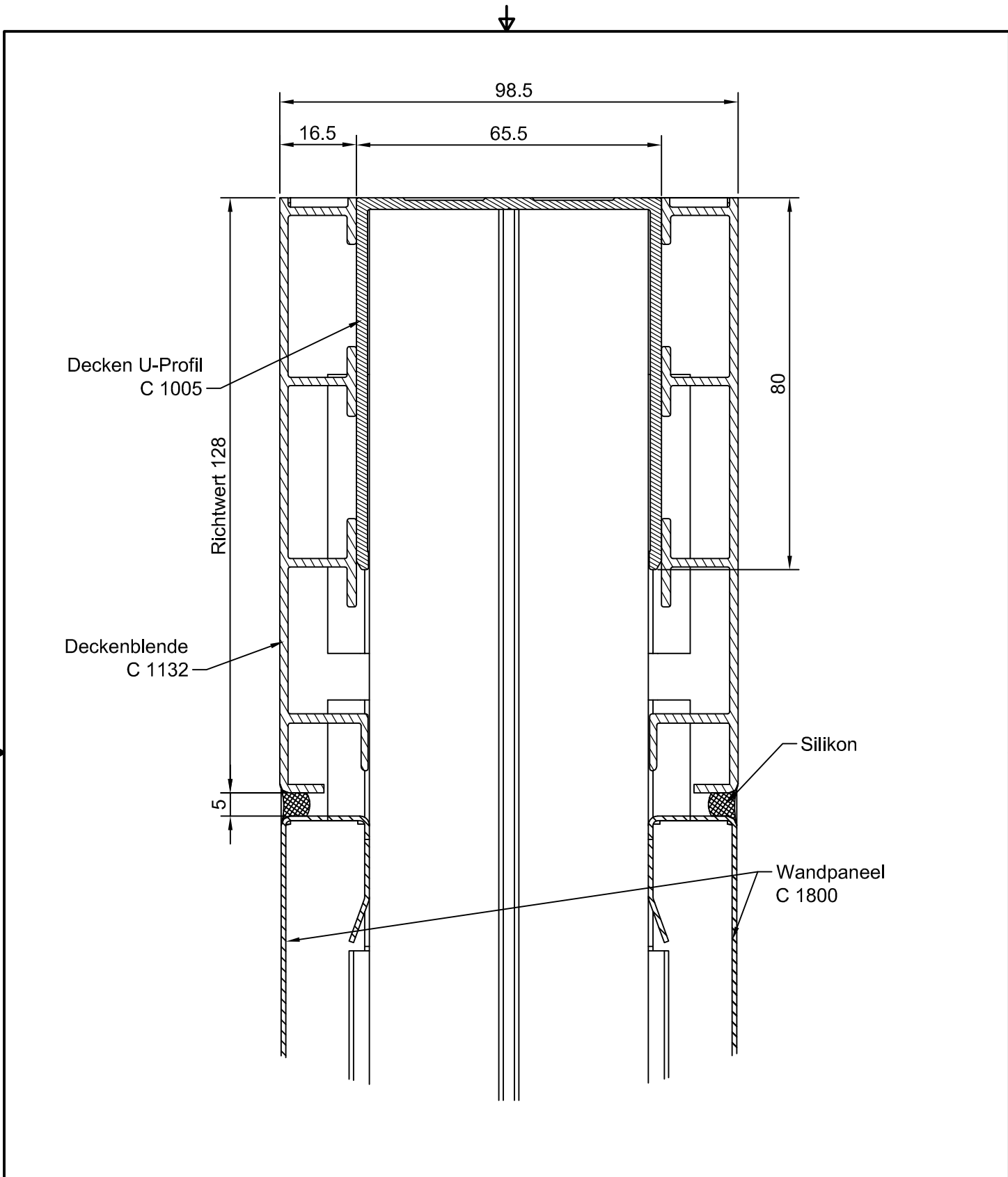

Alle Toleranzen nach DIN ISO 2768 mittel				Material		
This drawing is our literary property and may neither copied nor to be exposed approachable to third persons without our agreement; according to German Copyright Act						
				Datum	Name	Bezeichnung: Schnitt J: Deckenanschluss
				Gezeichnet	01.08.2014 jk	
				Kontrolliert		
				Norm		
				Projekt Nr.		Z-Nr: VRS_P98_11_0001
Status	Änderungen	Datum	Name			1 A4

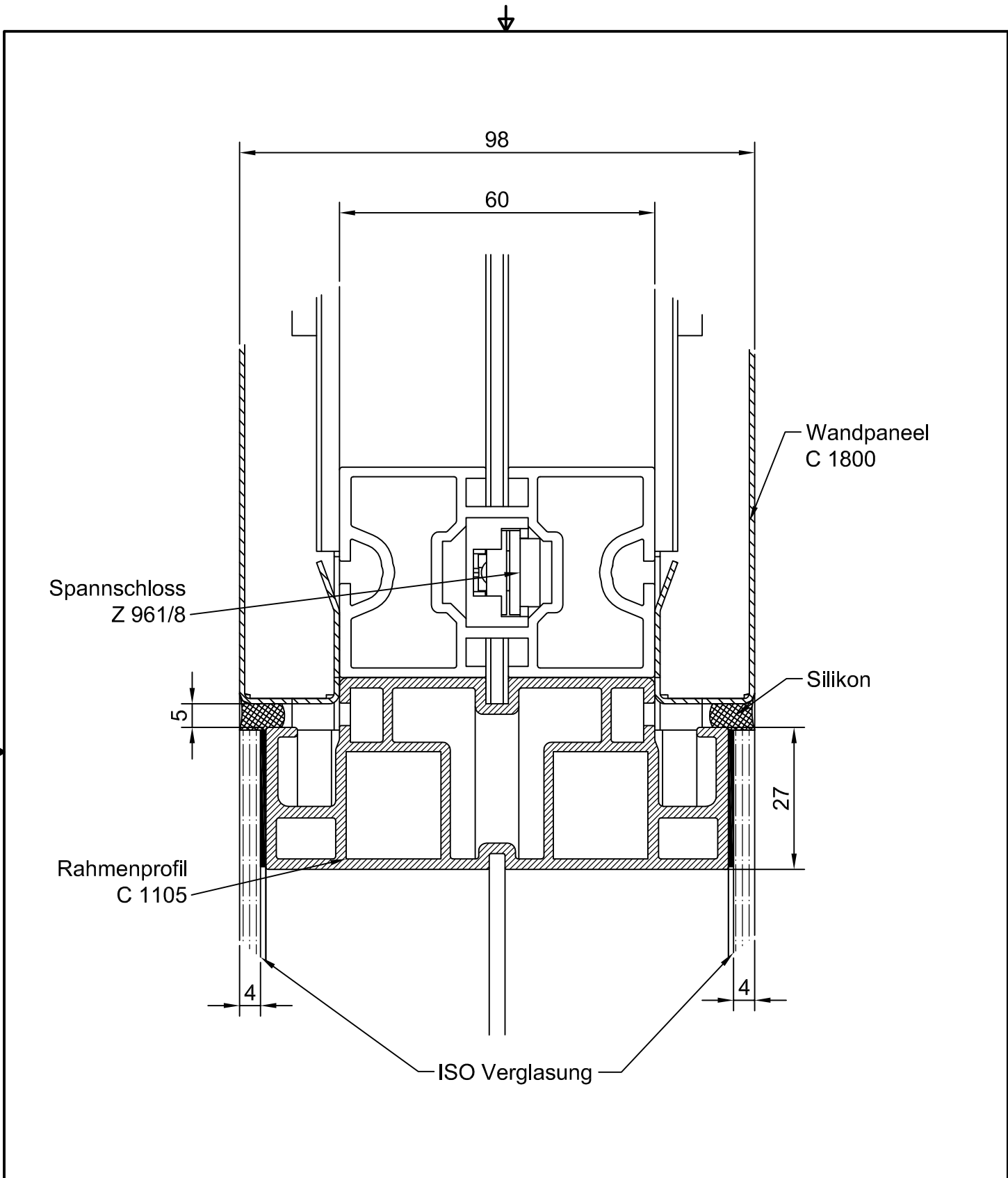

Alle Toleranzen nach DIN ISO 2768 mittel				Material		
This drawing is our literary property and may neither copied nor to be exposed approachable to third persons without our agreement; according to German Copyright Act						
				Datum	Name	Bezeichnung: Schnitt I: Verbindungsanschluss Paneel/ Glas
				Gezeichnet	01.08.2014 jk	
				Kontrolliert		
				Norm		
				Projekt Nr.		Z-Nr: VRS_P98_11_0002
Status	Änderungen	Datum	Name			1 A4

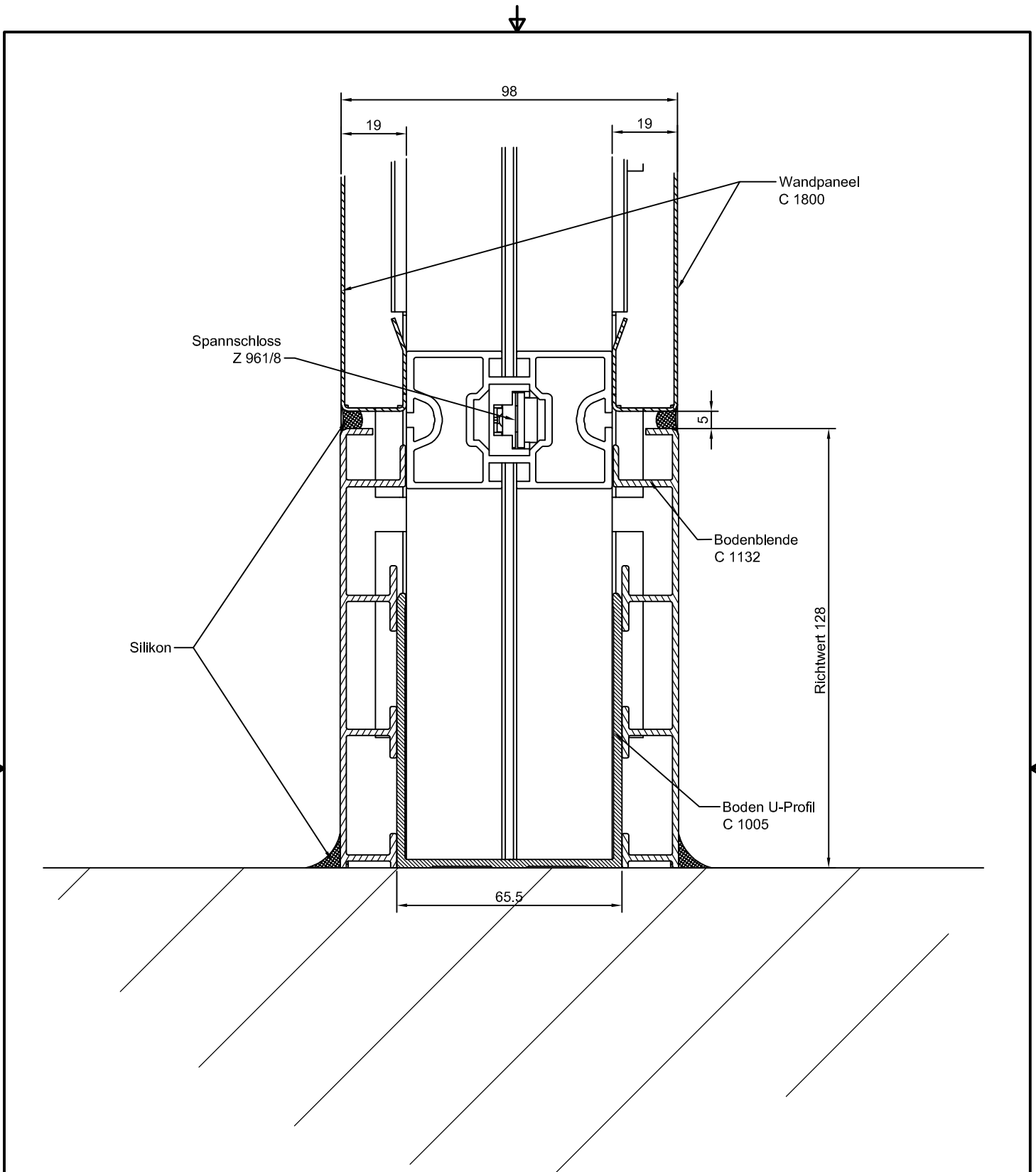

Alle Toleranzen nach DIN ISO 2768 mittel

Material



This drawing is our literary property and may neither copied nor to be exposed approachable to third persons without our agreement; according to German Copyright Act

				Datum	Name
				Gezeichnet 01.08.2014	jk
				Kontrolliert	
				Norm	

Bezeichnung:
Schnitt H:
Bodenanschluss Typ I

				Projekt Nr.	

Z-Nr: VRS_P98_11_0003

1
A4

Status	Änderungen	Datum	Name



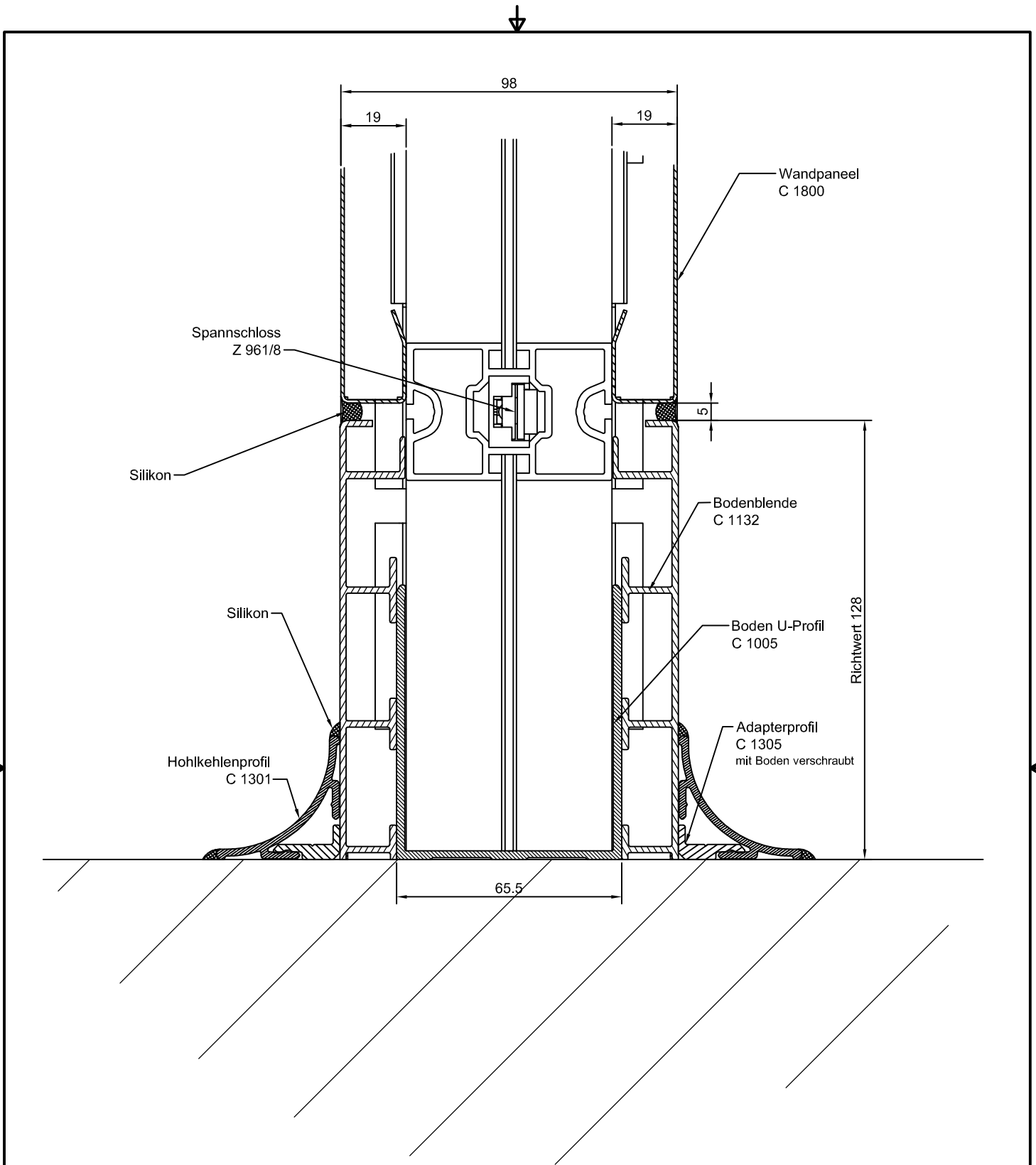

Alle Toleranzen nach DIN ISO 2768 mittel				Material			
This drawing is our literary property and may neither copied nor to be exposed approachable to third persons without our agreement; according to German Copyright Act							
				Datum	Name	Bezeichnung: Schnitt H: Bodenanschluss Typ II	
				Gezeichnet	01.08.2014		jk
				Kontrolliert			
				Norm			
				Projekt Nr.		Z-Nr: VRS_P98_11_0004	
							1 A4
Status	Änderungen	Datum	Name				

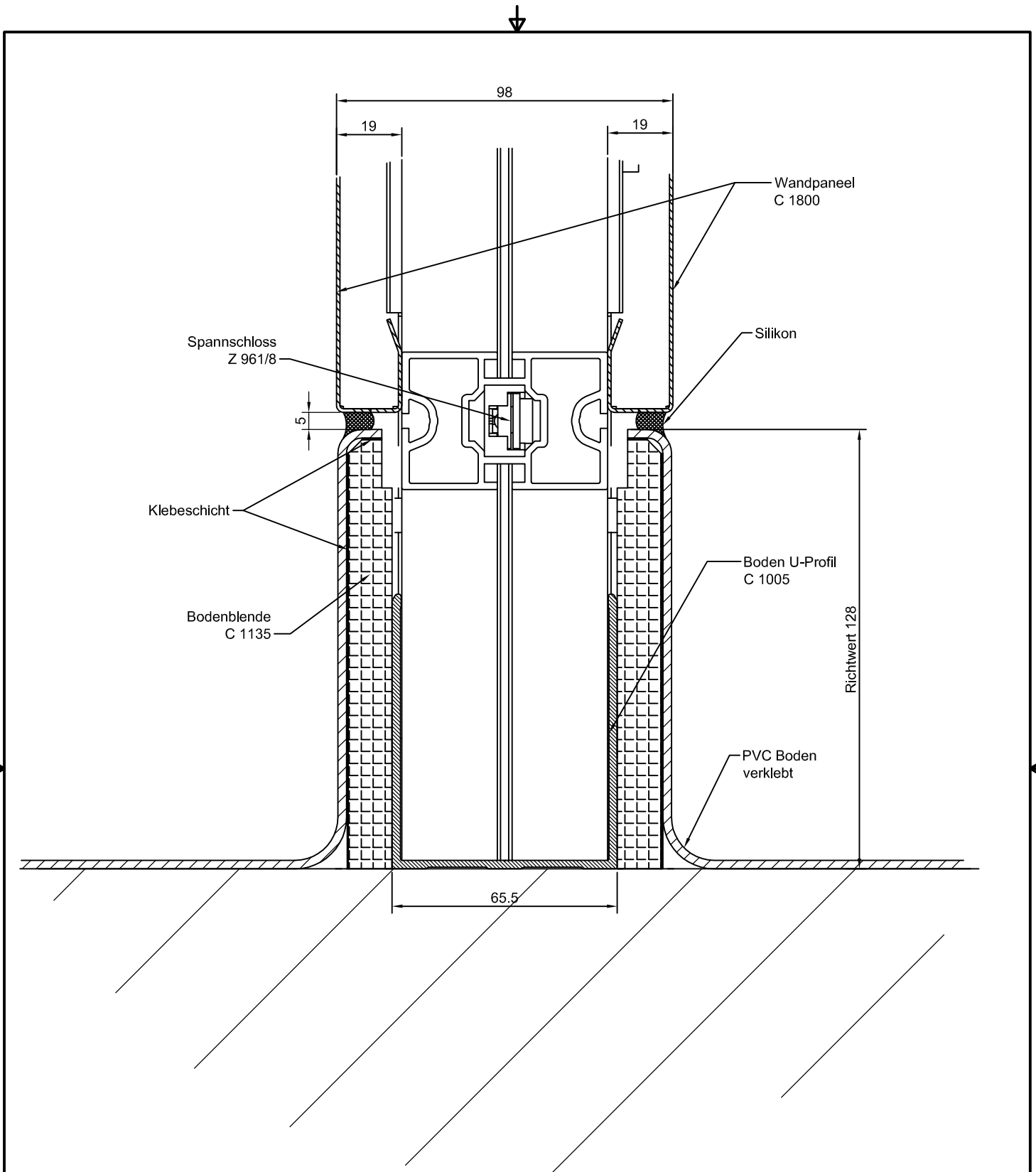

Alle Toleranzen nach DIN ISO 2768 mittel				Material			
This drawing is our literary property and may neither copied nor to be exposed approachable to third persons without our agreement; according to German Copyright Act							
				Datum	Name	Bezeichnung: Schnitt H: Bodenanschluss Typ III	
				Gezeichnet	01.08.2014		jk
				Kontrolliert			
				Norm			
				Projekt Nr.		Z-Nr: VRS_P98_11_0005	
							1 A4
Status	Änderungen	Datum	Name				

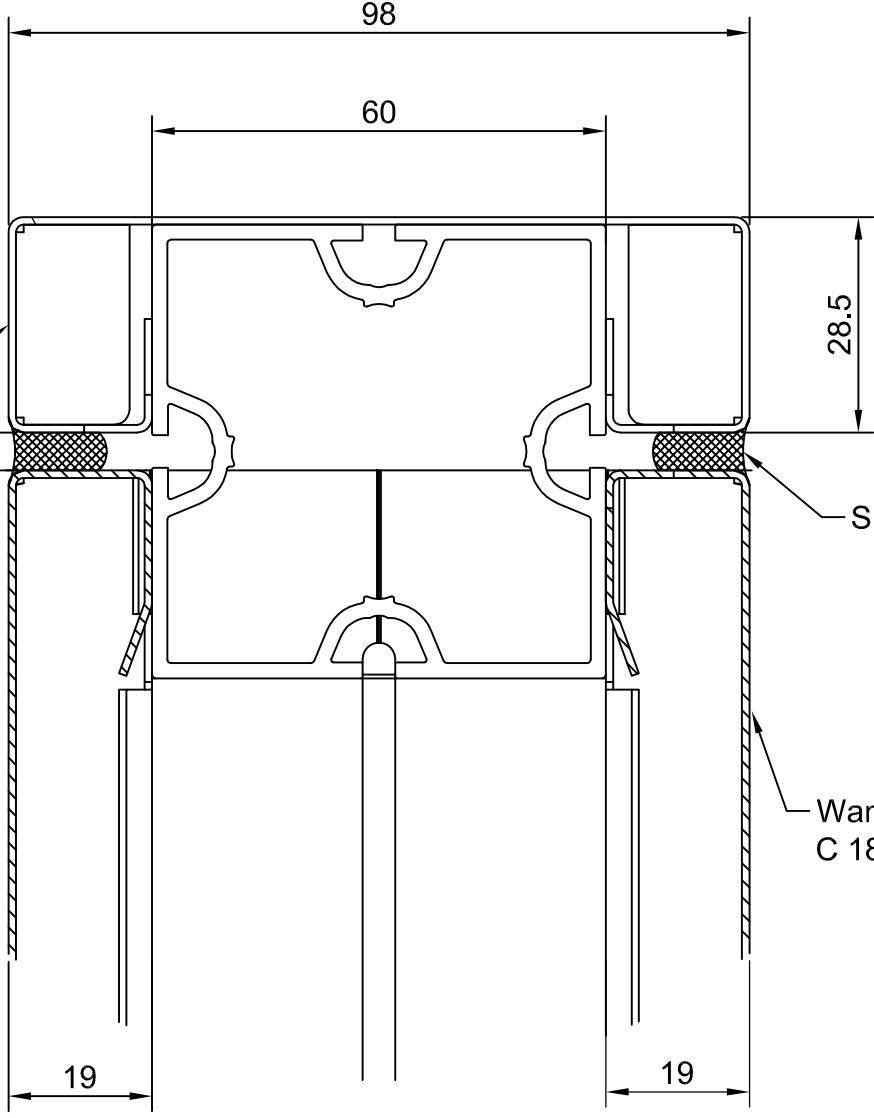

Abschlussblende
C 1267

5

98

60

28.5

Silikon

Wandpaneel
C 1800

19

19

Alle Toleranzen nach DIN ISO 2768 mittel

Material

This drawing is our literary property and may neither copied nor to be exposed approachable to third persons without our agreement; according to German Copyright Act



	Datum	Name
Gezeichnet	31.07.2014	jk
Kontrolliert		
Norm		

Bezeichnung:
Schnitt C:
Wandabschluss

Status	Änderungen	Datum	Name

Projekt Nr.

Z-Nr: VRS_P98_12_0001

1
A4



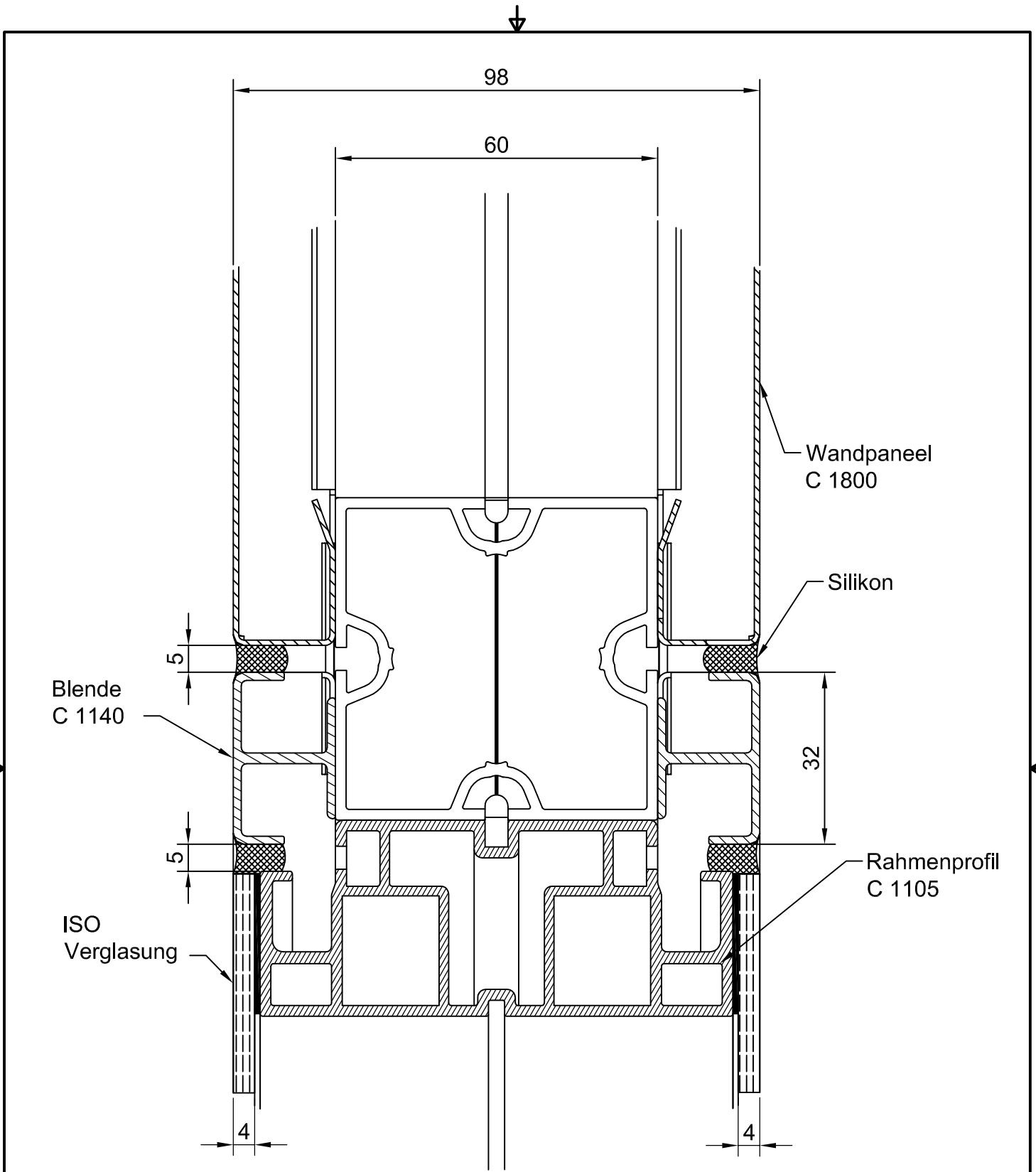

Alle Toleranzen nach DIN ISO 2768 mittel				Material		
This drawing is our literary property and may neither be copied nor to be exposed approachable to third persons without our agreement; according to German Copyright Act						
				Datum	Name	Bezeichnung: Schnitt D: Verbindungsanschluss Paneel/ Glas
				Gezeichnet	31.07.2014 jk	
				Kontrolliert		
				Norm		
				Projekt Nr.		Z-Nr: VRS_P98_12_0002
Status	Änderungen	Datum	Name			1 A4

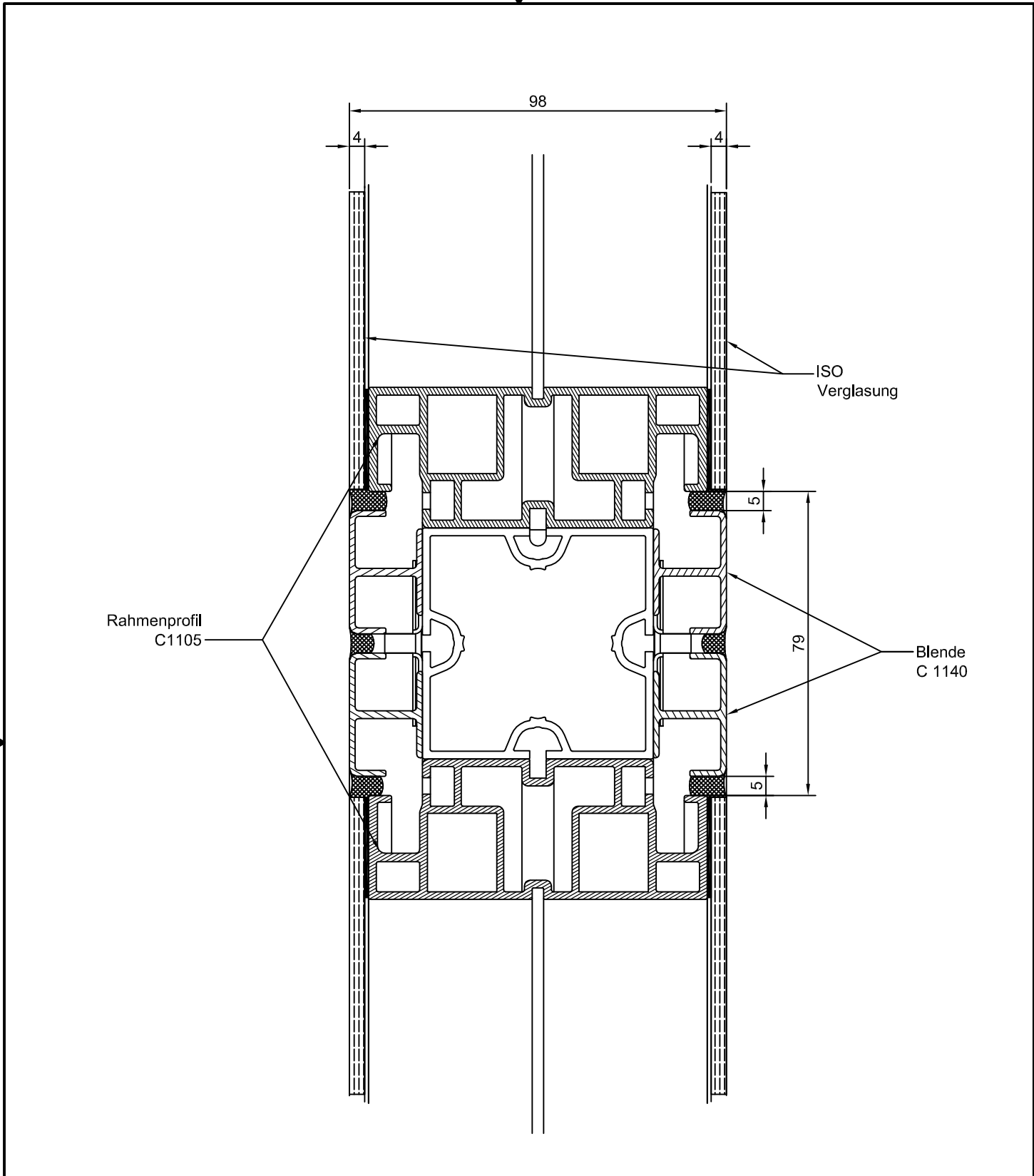

Alle Toleranzen nach DIN ISO 2768 mittel				Material			
This drawing is our literary property and may neither copied nor to be exposed approachable to third persons without our agreement; according to German Copyright Act							
				Datum	Name	Bezeichnung: Schnitt E: Verbindungsanschluss Glas/ Glas	
				Gezeichnet	31.07.2014		jk
				Kontrolliert			
				Norm			
				Projekt Nr.		Z-Nr: VRS_P98_12_0003	
							1 A4
Status	Änderungen	Datum	Name				



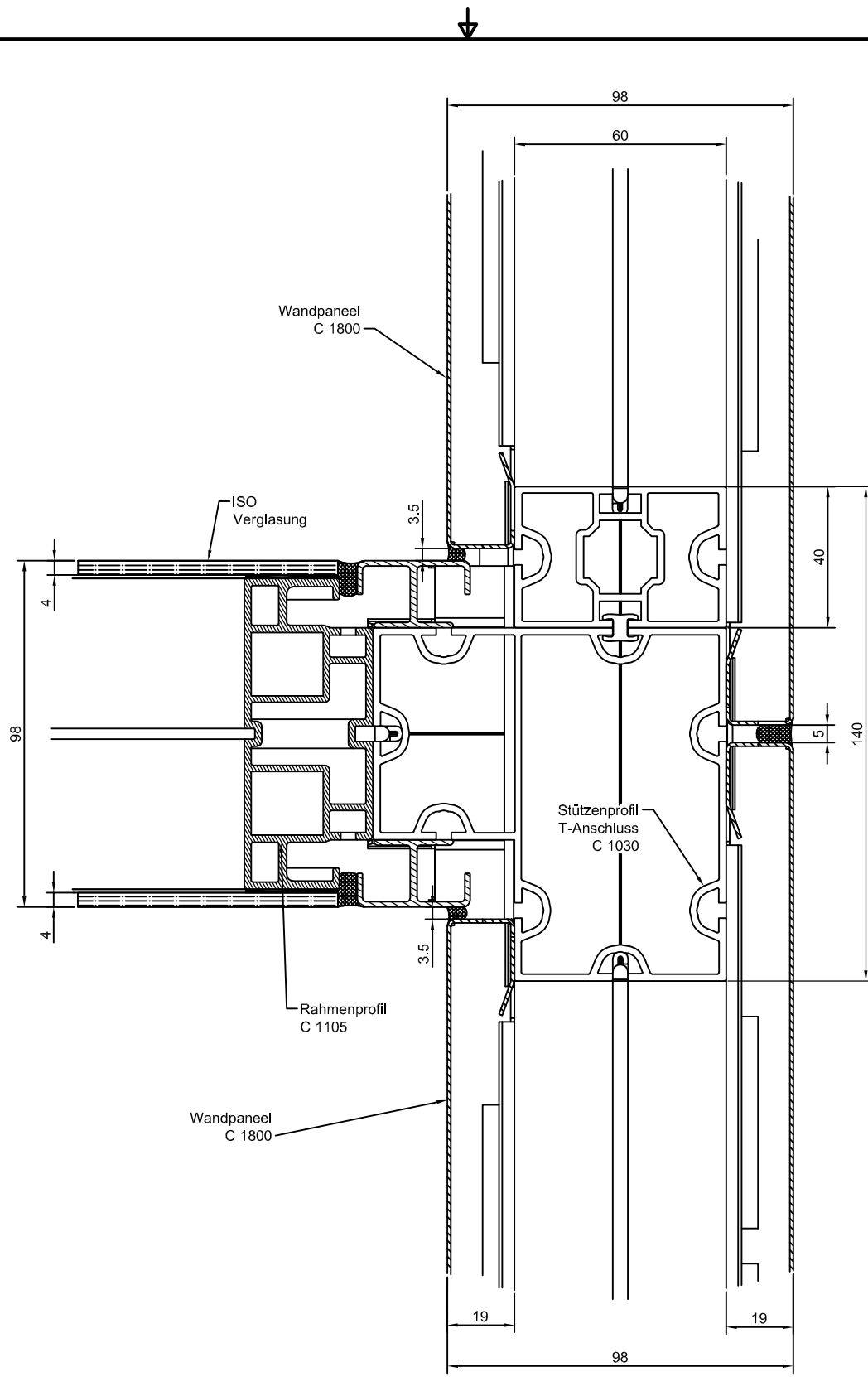

Alle Toleranzen nach DIN ISO 2768 mittel

Material

This drawing is our literary property and may neither copied nor to be exposed approachable to third persons without our agreement; according to German Copyright Act



	Datum	Name
Gezeichnet	31.07.2014	jk
Kontrolliert		
Norm		

Bezeichnung:
Schnitt F:
T - Anschluss Glas/ Paneel/ Pabeel

Projekt Nr.			

Z-Nr: VRS_P98_12_0004

Status	Änderungen	Datum	Name

1
A4

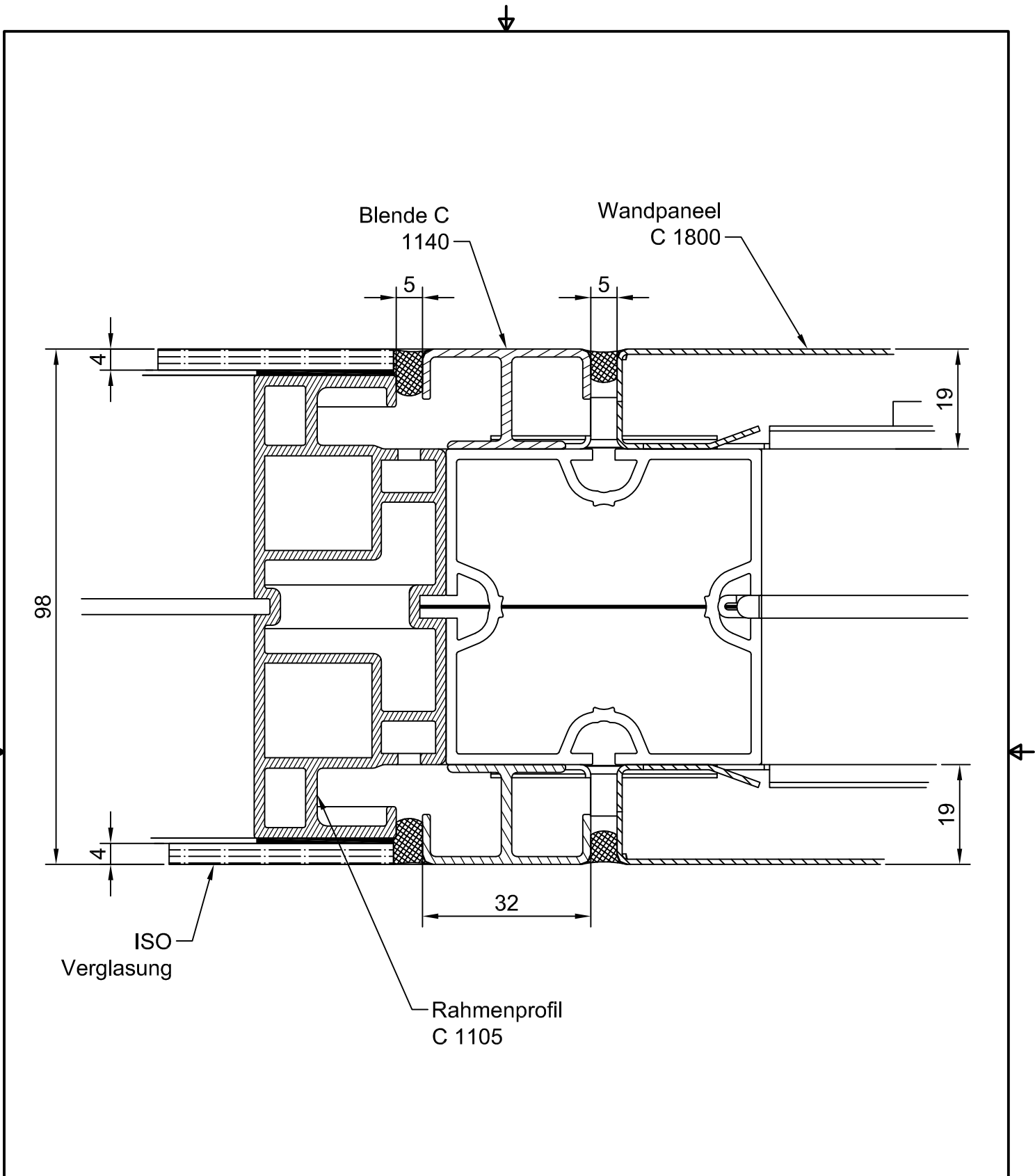

Alle Toleranzen nach DIN ISO 2768 mittel				Material			
This drawing is our literary property and may neither copied nor to be exposed approachable to third persons without our agreement; according to German Copyright Act							
				Datum	Name	Bezeichnung: Schnitt G: Verbindungsanschluss Paneel/ Glas	
				Gezeichnet	01.08.2014		jk
				Kontrolliert			
				Norm			
				Projekt Nr.		Z-Nr: VRS_P98_12_0005	
							1
Status	Änderungen	Datum	Name			A4	

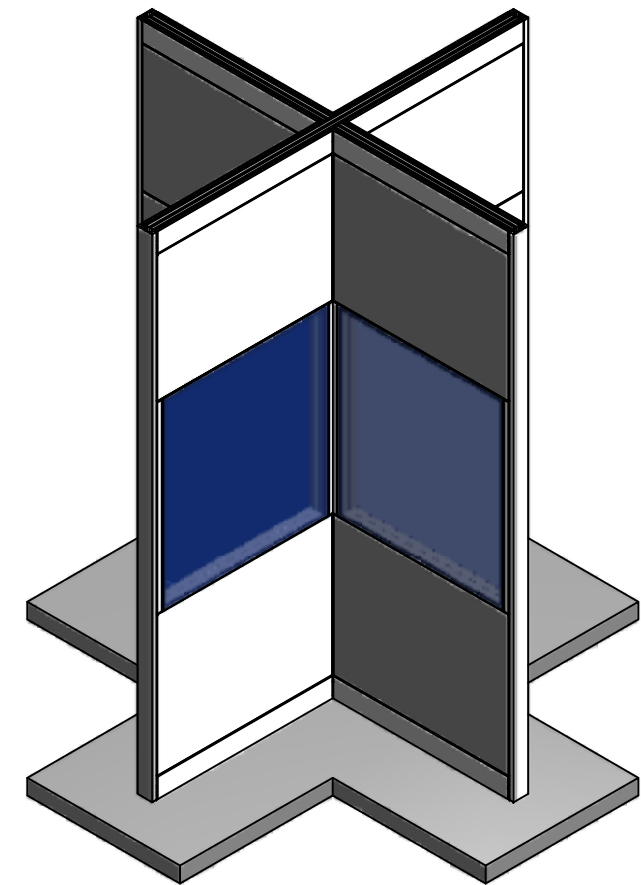
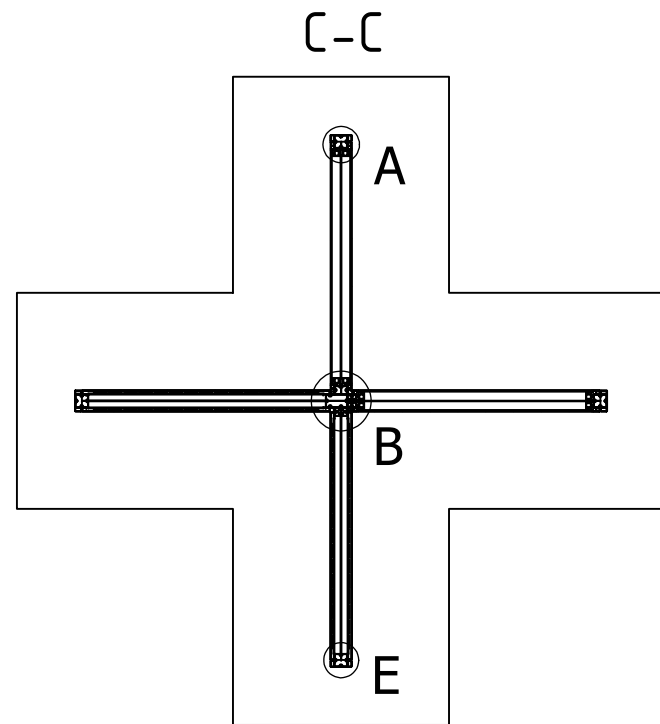
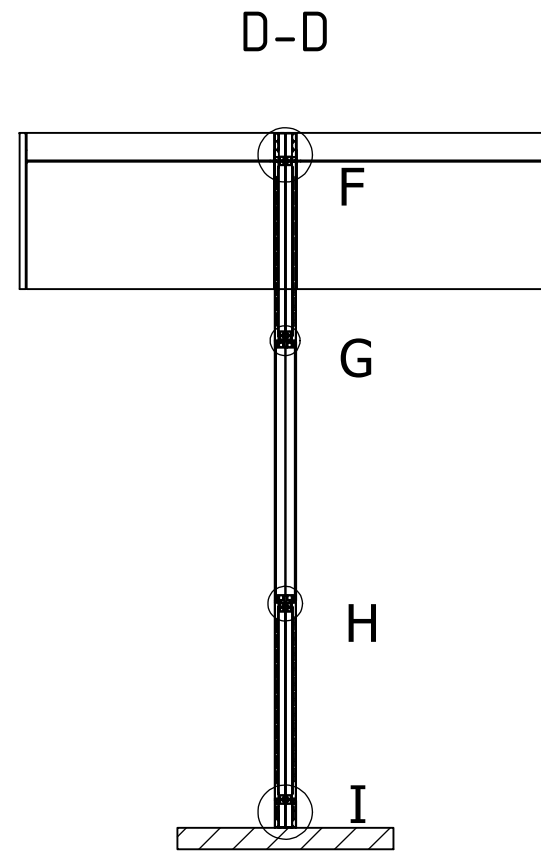
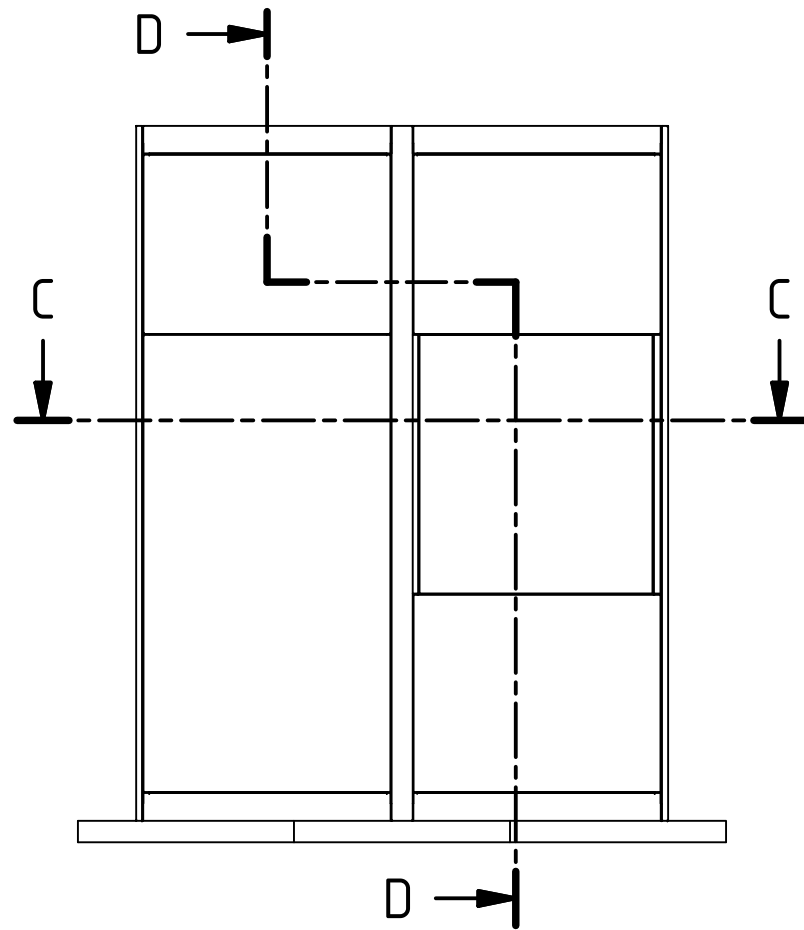

Alle Toleranzen nach DIN ISO 2768 mittel				Material		
This drawing is our literary property and may neither copied nor to be exposed approachable to third persons without our agreement; according to German Copyright Act						
				Datum	Name	Bezeichnung: Wansystem OCV 98 mm Wandkreuzung
				Gezeichnet	01.08.2014 jk	
				Kontrolliert		
				Norm		Z-Nr:VRS_P98_20_0000
				Projekt Nr.		
Status	Änderungen	Datum	Name			1 A3

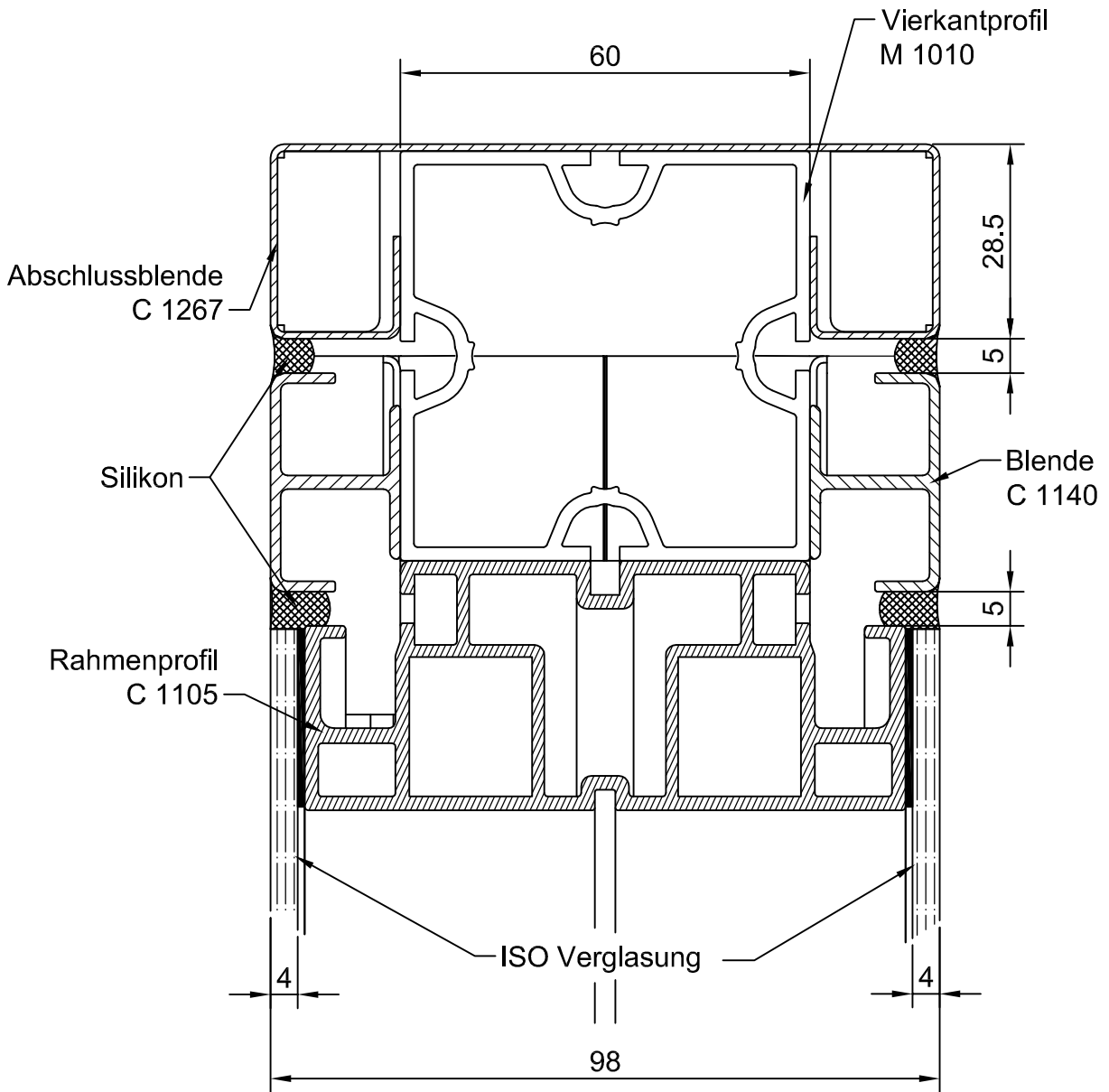

Alle Toleranzen nach DIN ISO 2768 mittel

This drawing is our literary property and may neither copied nor to be exposed approachable to third persons without our agreement; according to German Copyright Act

Material

OCTANORM 

				Datum	Name
				Gezeichnet 04.08.2014	jk
				Kontrolliert	
				Norm	

Bezeichnung:

Schnitt A:
Wandabschluss

				Projekt Nr.

Z-Nr: VRS_P98_22_0001

1
A4

Status	Änderungen	Datum	Name

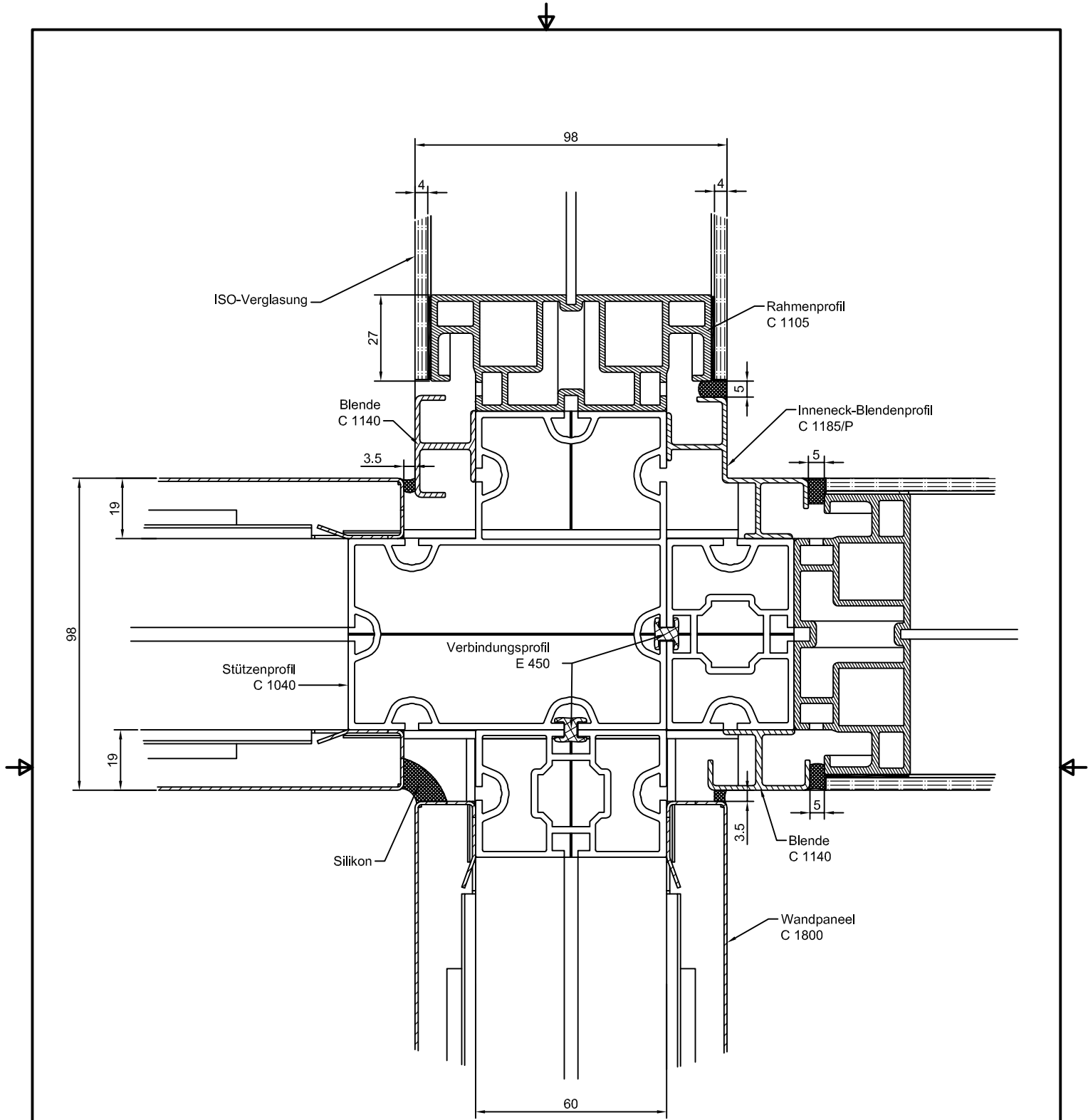

Alle Toleranzen nach DIN ISO 2768 mittel

This drawing is our literary property and may neither copied nor to be exposed approachable to third persons without our agreement; according to German Copyright Act

Material

OCTANORM 

				Datum	Name
				Gezeichnet 04.08.2014	jk
				Kontrolliert	
				Norm	

Bezeichnung:

Schnitt B:
Kreuz-Anschluss Paneel/ Paneel/ Glas/ Glas

				Projekt Nr.

Z-Nr: VRS_P98_22_0002

1

A4

Status	Änderungen	Datum	Name

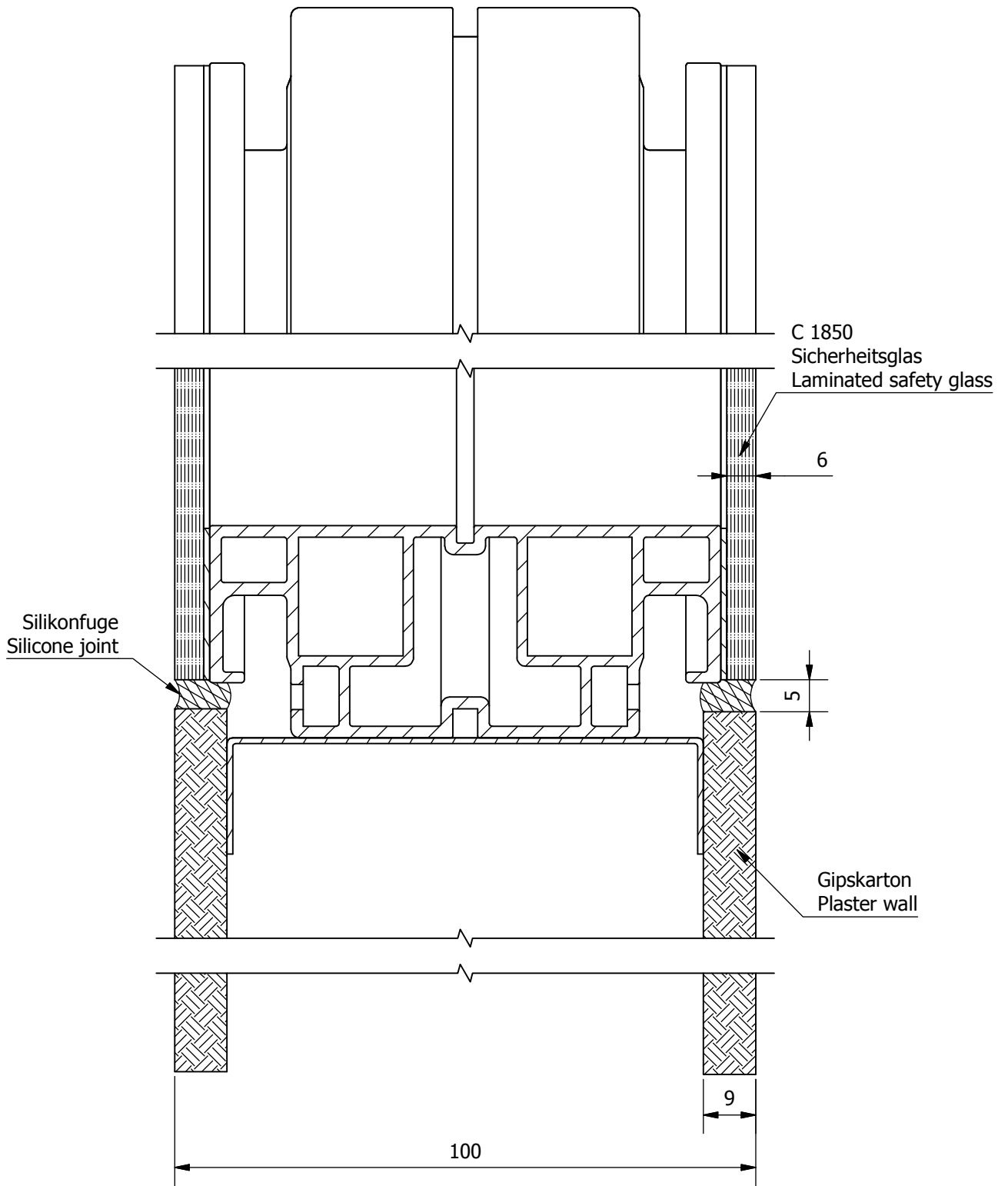

Alle Toleranzen nach DIN ISO 2768 mittel

Material



This drawing is our literary property and may neither copied nor to be exposed approachable to third persons without our agreement; according to German Copyright Act

Description / Bezeichnung:

Wandanschluss Verglasung/ Gipskarton
Wall connection glazing/ plaster panel

		Datum	Name
	Gezeichnet	02.12.2014	jk
	Kontrolliert		
	Norm		
Projekt Nr.			
Status	Änderungen	Datum	Name

Z-Nr:VRS_P98_30_0001

1

A4