

# TECHNICAL MANUAL

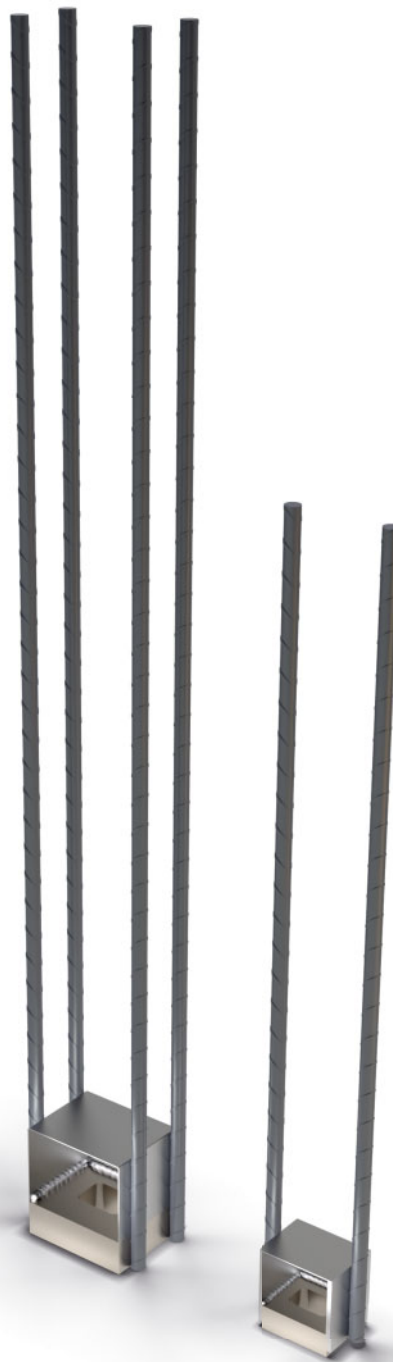

## SUMO<sup>®</sup> Wall Shoe

For Bolted Wall Connections

Version: PEIKKO GROUP 11/2014



# SUMO Wall Shoe

For bolted wall connections

## System benefits

- Strong tensile connection: enables shear walls to be built of precast concrete elements
- Quick and easy erection of walls with good adjustment possibilities
- Connection does not require in-situ welding
- Connections are able to transfer tensile forces immediately after elements are erected

SUMO Wall Shoe is a building product used to create cost-effective tensile connections between:

- Precast concrete walls and foundations
- Two precast concrete walls

The system consists of wall shoes and anchor bolts. Wall shoes are cast into precast concrete walls, whereas anchor bolts are cast into foundations or other walls. On site, the walls are erected on adjusted shim plates in the correct position and fixed to the anchor bolts.

Precast concrete wall connections are finalized by grouting the recesses and joints underneath the wall.



# Contents

About SUMO Wall Shoe	4
<b>1. Product Properties</b>	<b>4</b>
<b>1.1 Structural behavior</b>	<b>5</b>
<b>1.2 Application conditions</b>	<b>5</b>
1.2.1 Loading and environmental conditions	5
1.2.2 Positioning of the wall shoe	5
<b>1.3 Other properties</b>	<b>6</b>
<b>2. Resistances</b>	<b>8</b>
<b>2.1 Fire resistance</b>	<b>8</b>
Selecting SUMO Wall Shoe	9
Appendix A – Supplementary reinforcement	10
<b>Supplementary reinforcement for overlapping</b>	<b>11</b>
Models with two anchor bars	11
Models with four anchor bars	14
Installation of SUMO Wall Shoe	15

## 1. Product Properties

SUMO Wall Shoes are available in several standard models to suit most precast concrete wall connections. The system consists of:

- Wall shoes
- Anchor bolts
- Square washers

SUMO Wall Shoes are used with Peikko Anchor Bolts to create precast concrete wall connections. Wall shoes are cast into the bottom part of the wall together with main and supplementary reinforcement, detailed in Appendix A of this manual. HPM and PPM Anchor Bolts are either cast into the foundations (wall-foundation connection) or in the top part of the lower wall (wall-wall connection). The wall shoe has a rectangular hole that fits with the corresponding anchor bolt. The wall connection is developed by fastening the anchor bolts to wall shoes by using nuts and washers. The bolted connection offers sufficient assembly tolerances to adjust the wall into the correct position. To finalize the connection, the recesses and joint underneath the wall are grouted with grout material.

The product range consists of wall shoe models that include two or four anchor bars depending on the tensile resistance values of the wall shoe. The models are presented in Figure 2.

Figure 1. SUMO Wall Shoe and HPM, PPM Anchor Bolts in wall connection.



Figure 2. Connecting SUMO Wall Shoe and HPM, PPM Anchor Bolts

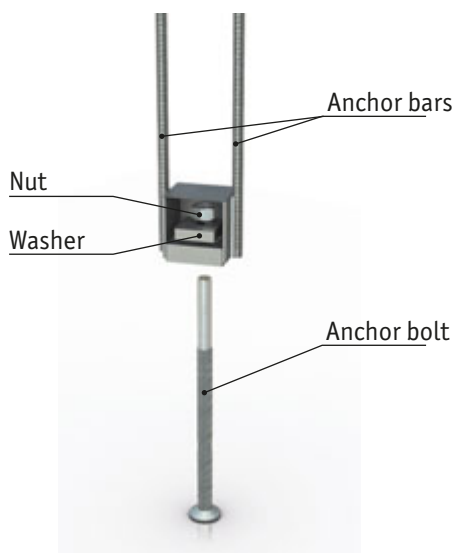

Model with two anchor bars  
(SUMO 16H, SUMO 20H, SUMO 24H, SUMO 30H,  
SUMO 39H, SUMO 30P, SUMO 36P)

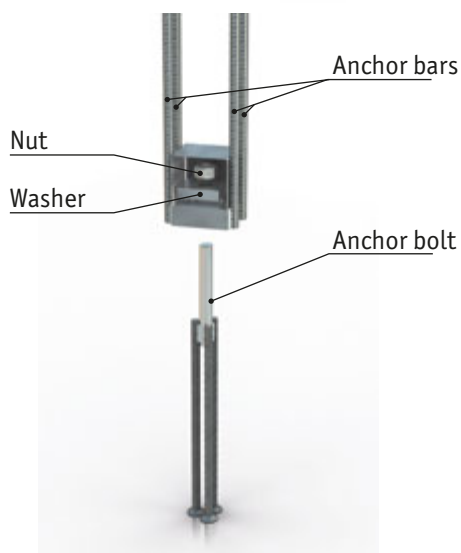

Model with four anchor bars  
(SUMO 39P, SUMO 45P, SUMO 52P)

The design values of resistances of SUMO Wall Shoes are equal to the design values of resistances of corresponding HPM and PPM Anchor Bolts. For more information about anchor bolts, see the Technical Manual of HPM and PPM Anchor Bolts.

## 1.1 Structural behavior

Wall connections are designed to transfer tensile forces between the two connected wall elements. The compressive forces are transmitted via the grouting of the joint.

SUMO Wall Shoes are designed to offer sufficient resistance to withstand the maximal design values for tensile forces from the corresponding HPM and PPM Anchor Bolts. In bottom or intermediate precast wall elements, these tensile forces are transferred from the bottom of the wall element (wall shoe) to the top of the wall element (anchor bolt) by vertical continuity reinforcement (rebar B 500B lapped with wall shoe and anchor bolt).

Figure 3. Structural behavior of the wall connection.

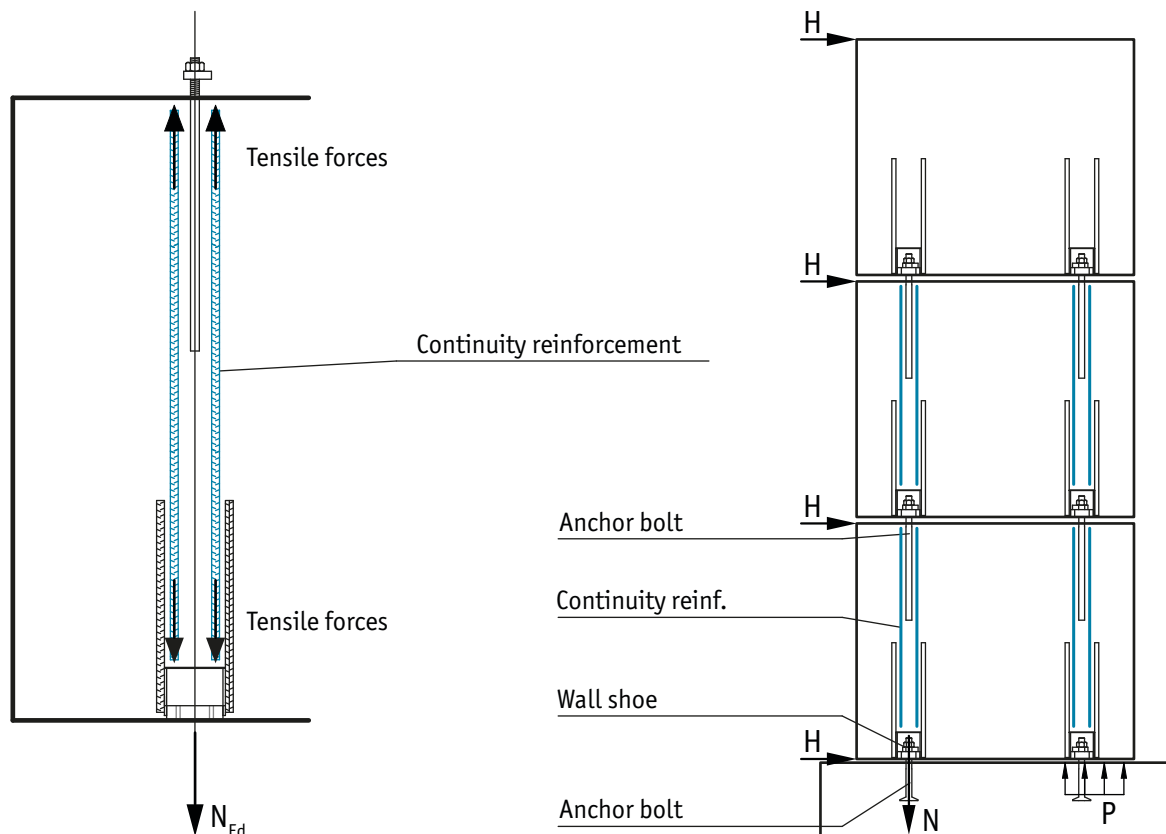

## 1.2 Application conditions

The standard models of SUMO Wall Shoes are designed to be used under the conditions mentioned in this chapter. If these conditions may not be satisfied, please contact Peikko Technical Support for custom designs of SUMO Wall Shoes.

### 1.2.1 Loading and environmental conditions

SUMO Wall Shoes are designed to carry static loads. They are designed to be used in indoors and in dry conditions. When using SUMO Wall Shoes in other conditions, the surface treatment, concrete cover, or raw materials must be suitable for the environmental exposure class and intended operating life.

### 1.2.2 Positioning of the wall shoe

SUMO Wall Shoes are designed to be used in reinforced concrete walls with minimum concrete cover as summarized in Table 1. The standard properties of SUMO Wall Shoes are guaranteed in reinforced concrete walls made of concrete grade C25/30 or higher. For the minimum concrete grade for anchor bolts, see the Technical Manual for

HPM and PPM Anchor Bolts. If these conditions may not be satisfied, please contact Peikko Technical Support for custom designs of SUMO Wall Shoes.

Figure 4. Minimum concrete cover of the anchor bars.

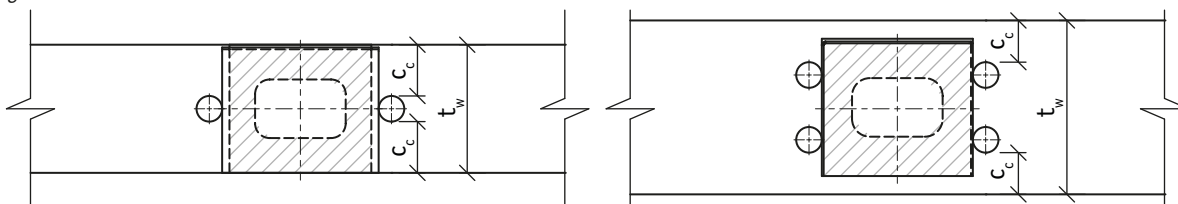

Table 1. Minimum thickness [mm] of wall cross-sections and minimum concrete cover for standard SUMO Wall Shoes.

Wall Shoe	SUMO 16H	SUMO 20H	SUMO 24H	SUMO 30H	SUMO 39H	SUMO 30P	SUMO 36P	SUMO 39P	SUMO 45P	SUMO 52P
Minimum concrete cover $c_c$ [mm]	35	35	35	35	38	38	42	38	42	42
Minimum thickness of wall $t_w$ [mm]	90	90	110	120	145	130	150	190	210	250

Determination of the concrete cover was calculated with structural class S4 and exposure class - XC2/XC3 (see EN 1992-1-1 4.4.1)

Figure 5. Minimum edge and center distances.

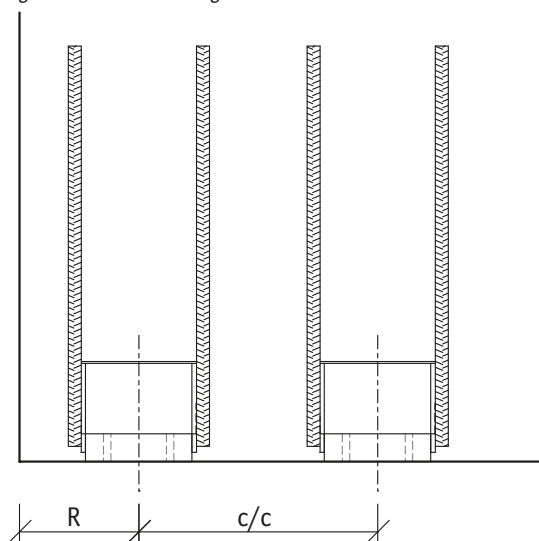

Table 2. Minimum edge and center distances [mm].

Wall Shoe	Edge distances R [mm]	Center distances c/c [mm]
SUMO 16H	160	320
SUMO 20H	170	340
SUMO 24H	190	380
SUMO 30H	210	420
SUMO 39H	240	480
SUMO 30P	220	440
SUMO 36P	250	500
SUMO 39P	200	400
SUMO 45P	210	420
SUMO 52P	250	500

Distances that are used in Table 2 are based on concrete cone failure method.

The structural properties of SUMO Wall Shoes are guaranteed only if supplementary reinforcement is provided in the wall in accordance with the rules set out in Appendix A to this Technical Manual. It is notable that the supplementary reinforcement is used in addition to the main reinforcement designed to resist internal forces in the wall.

## 1.3 Other properties

SUMO Wall Shoes are made of steel plates and reinforcing bars with the following material properties:

<b>Steel plates</b>	S355J2+N	EN 10025-2
<b>Ribbed bars</b>	B500B	EN 10080 DIN 488

Peikko Group's production units are externally controlled and periodically audited on the basis of production

certifications and product approvals by various organizations, including Inspecta Certification, VTT Expert Services, Nordcert, SLV, TSUS, SPSC.

The products bear the inspection mark, the emblem of Peikko Group, the type of product, and the year and week of manufacturing.

Figure 6. Dimension [mm] of SUMO Wall Shoe.

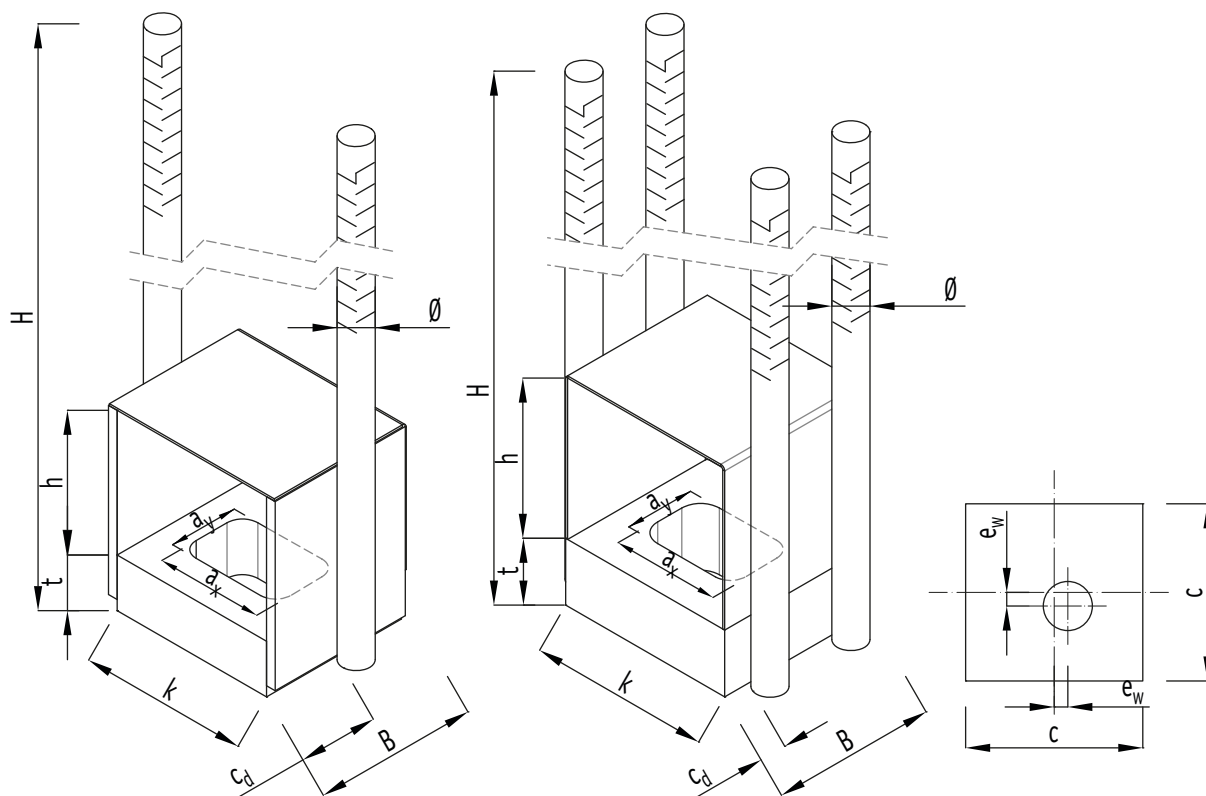











Table 3. Dimensions [mm], weights [kg] and color codes of Wall Shoes.

Wall Shoe	SUMO 16H	SUMO 20H	SUMO 24H	SUMO 30H	SUMO 39H	SUMO 30P	SUMO 36P	SUMO 39P	SUMO 45P	SUMO 52P
B	80	90	110	120	145	130	150	150	180	230
k	115	120	135	140	165	145	160	165	175	250
t	30	35	35	40	50	45	55	60	70	80
h	80	90	100	115	130	120	130	145	160	185
H	580	850	960	1170	1590	1350	1755	1820	2015	2590
a <sub>y</sub>	36	40	49	55	64	55	61	64	75	82
a <sub>x</sub>	76	80	84	90	99	90	96	99	105	112
Ø	14	16	20	25	28	28	32	28	32	32
c <sub>d</sub>	33	37	45	47,5	58,5	51	59	19	26	31
c	60	65	80	95	115	95	110	115	130	155
e <sub>w</sub>	5	5	10	10	10	10	10	10	10	10
Weight	3.9	6.0	9.6	15.2	26.7	21.3	35.1	46.2	66.9	100.4
Color code	yellow	blue	gray	green	orange	black	red	brown	purple	white
										

Lap lengths of anchor bars are defined according to concrete grade C25/30 in good bond conditions.

## 2. Resistances

The resistances of SUMO Wall Shoes are determined by a design concept that makes reference to the following standards:

- EN 1992-1-1:2004/AC:2010
- EN 1993-1-1:2005/AC:2009
- EN 1993-1-8:2005

SUMO Wall Shoes are designed to withstand tensile forces corresponding to the design values of resistances of HPM and PPM Anchor Bolts. The maximum design values of resistances of individual SUMO Wall Shoes are given in Table 4.

Table 4. Design values of resistances of individual SUMO Wall Shoes for concrete grade C25/30.

Wall Shoe	Anchor Bolt	Washer	$N_{Rd}$ [kN]
SUMO 16H	HPM 16	AL 16	62
SUMO 20H	HPM 20	AL 20	96
SUMO 24H	HPM 24	AL 24	139
SUMO 30H	HPM 30	AL 30	220
SUMO 39H	HPM 39	AL 39	383
SUMO 30P	PPM 30	AL 30	299
SUMO 36P	PPM 36	AL 36	436
SUMO 39P	PPM 39	AL 39	521
SUMO 45P	PPM 45	AL 45	697
SUMO 52P	PPM 52	AL 52	938

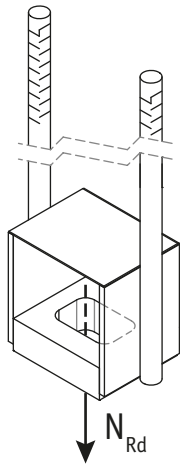

The resistance of the SUMO Wall Shoe is valid for tensile force  $N_{Rd}$  acting in the anchor bolt.

### 2.1 Fire resistance

The concrete cover of the anchor bolt and the anchor bars of the wall shoes should be at least equivalent to the concrete cover of the reinforcement of the precast wall elements. If the fire resistance of the wall shoe connection is judged to be insufficient, the concrete cover of the wall shoe must be increased by increasing the thickness of the precast wall.



## Selecting SUMO Wall Shoe

The following aspects must be considered when selecting the appropriate type of SUMO Wall Shoe to be used in a wall connection:

- Resistance
- Properties of the wall
- Position and arrangement of the wall shoes in the wall

External forces (dead load, wind load) acting on the precast wall generate tensile forces in the horizontal joints between the precast elements. The tensile forces must be determined within the global analysis of the structure in accordance with relevant design standards. The appropriate model of wall shoe and anchor bolt is selected so that they have sufficient resistance compared to the design value of tensile force in the joint (see Table 4).

### Design example 1:

- Tensile force in joint (per one wall shoe)  $N_{Ed} = 356,0$  kN

Selected anchor bolt and wall shoe:

- Anchor Bolt **HPM 39 + AL 39**
- Wall Shoe **SUMO 39H**
- Washer **AL 39**
- Resistance element  **$N_{Rd} = 383.4$  kN**

$$N_{Ed} < N_{Rd}$$

$$356.0 < 383.4 \text{ kN}$$

### Design example 2:

- Tensile force in joint (per one wall shoe)  $N_{Ed} = 505.0$  kN

Selected anchor bolt and wall shoe:

- Anchor Bolt **PPM 39 + AL 39**
- Wall Shoe **SUMO 39P**
- Washer **AL 39**
- Resistance element  **$N_{Rd} = 520.5$  kN**

$$N_{Ed} < N_{Rd}$$

$$505.0 < 520.5 \text{ kN}$$

Wall Shoes with suffix H are connected with HPM Anchor Bolts.

**SUMO 39H → HPM 39 + AL 39**



Wall Shoes with suffix P are connected with PPM Anchor Bolts.

**SUMO 39P → PPM 39 + AL 39**



## Supplementary reinforcement

Details of supplementary reinforcement for SUMO Wall Shoes are shown in following figures.

For bottom or intermediate wall elements, continuity reinforcement must be provided to transfer the tensile loads from the wall shoe (in the bottom of the element) to the anchor bolt (in the top of the element) – Figure 7.

Figure 7. Continuity reinforcement and transverse reinforcement in precast wall system.

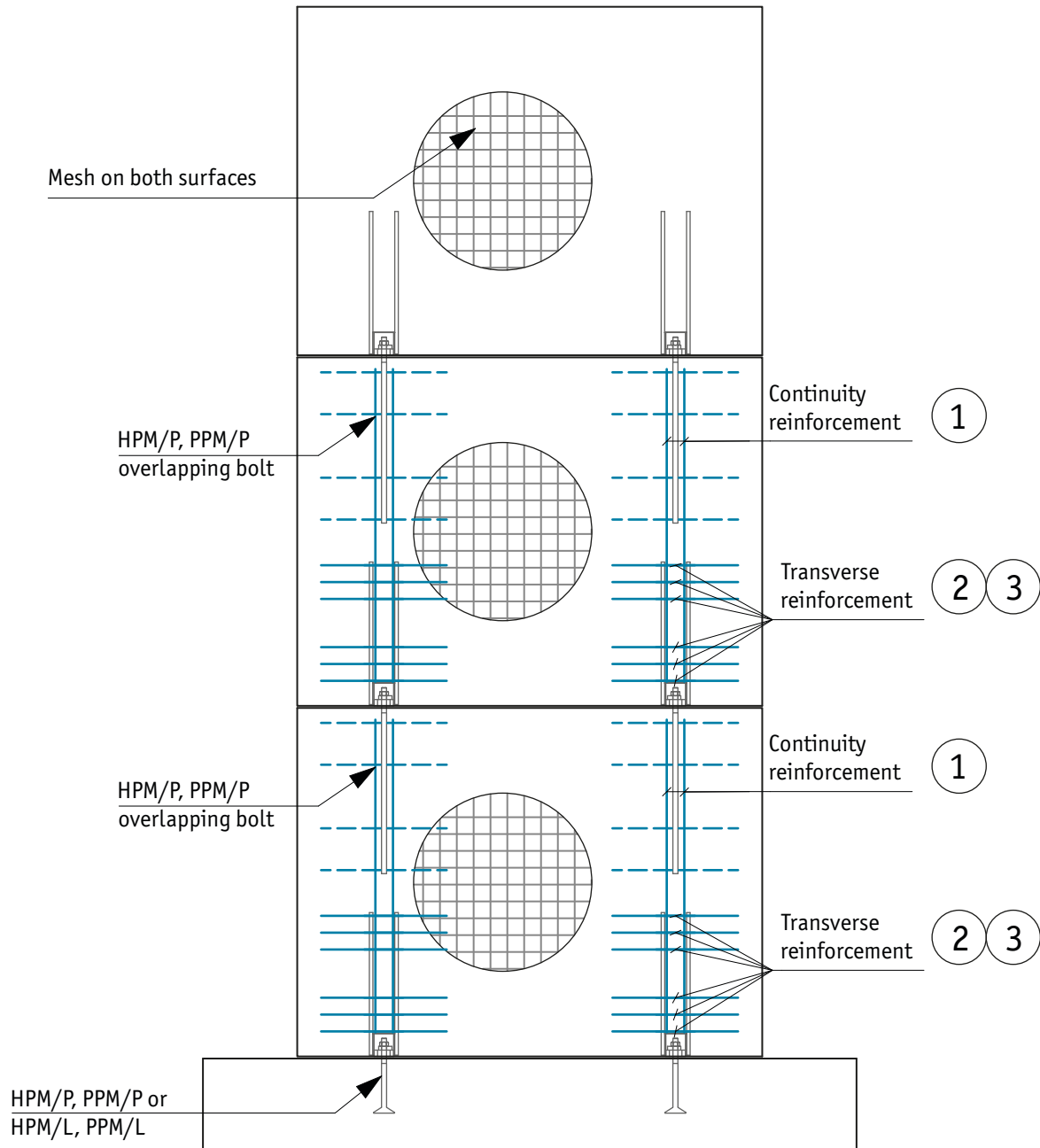

The amount of continuity reinforcement required is specified in Table 5 and Table 6. The continuity reinforcement is lap spliced with the anchor bars of the wall shoe. Transverse reinforcement must be provided in the lap splice zones in accordance with Figure 8 or Figure 9. Shape and possible bending of transverse reinforcement must be designed taking paragraph 8.7.4 of EN 1992-1-1 into consideration.

Transverse reinforcement designed in accordance with paragraph 8.7.4 of EN 1992-1-1 must be provided in the lap splice zones between the continuity reinforcement and the anchor bolt in the top part of the wall element.

## Supplementary reinforcement for overlapping

### Models with two anchor bars

Table 5. Required supplementary reinforcement (B500B).

Wall Shoe		SUMO 16H	SUMO 20H	SUMO 24H	SUMO 30H	SUMO 39H	SUMO 30P	SUMO 36P
<b>Supplementary continuity reinforcement</b>								
Reinforcement bars ①		2 Ø 14	2 Ø 16	2 Ø 20	2 Ø 25	2 Ø 28	2 Ø 28	2 Ø 32
<b>Supplementary transverse reinforcement on one side*</b>								
Additional mesh ②	$\emptyset_{m,1}$ [mm]	Ø 6	Ø 6	Ø 8	Ø 8	Ø 10	Ø 10	Ø 10
	$a_{m,1}$ [mm]	100	100	100	100	150	150	150
	$n_1$ [-]	2	3	3	4	4	4	5
	$l_{m,1}$ [mm]	200	300	300	400	550	550	700
	$l_{tr}$ [mm]	200 <sup>1</sup> /255 <sup>2</sup>	200 <sup>1</sup> /255 <sup>2</sup>	240 <sup>1</sup> /340 <sup>2</sup>	240 <sup>1</sup> /340 <sup>2</sup>	300 <sup>1</sup> /425 <sup>2</sup>	300 <sup>1</sup> /425 <sup>2</sup>	300 <sup>1</sup> /425 <sup>2</sup>
	$l_{tot,tr}$ [mm]	560 <sup>1</sup> /670 <sup>2</sup>	560 <sup>1</sup> /670 <sup>2</sup>	670 <sup>1</sup> /870 <sup>2</sup>	680 <sup>1</sup> /885 <sup>2</sup>	830 <sup>1</sup> /1080 <sup>2</sup>	820 <sup>1</sup> /1070 <sup>2</sup>	845 <sup>1</sup> /1095 <sup>2</sup>
<b>Supplementary transverse reinforcement on both sides*</b>								
2 x Additional mesh ②	$\emptyset_{m,2}$ [mm]	Ø 6	Ø 6	Ø 8	Ø 8	Ø 10	Ø 10	Ø 10
	$a_{m,2}$ [mm]	100	100	100	150	150	150	150
	$n_2$ [-]	2	2	2	2	2	2	3
	$l_{m,2}$ [mm]	200	200	200	250	250	250	400
	$l_{tr}$ [mm]	200 <sup>1</sup> /255 <sup>2</sup>	200 <sup>1</sup> /255 <sup>2</sup>	240 <sup>1</sup> /340 <sup>2</sup>	240 <sup>1</sup> /340 <sup>2</sup>	300 <sup>1</sup> /425 <sup>2</sup>	300 <sup>1</sup> /425 <sup>2</sup>	300 <sup>1</sup> /425 <sup>2</sup>
	$l_{tot,tr}$ [mm]	560 <sup>1</sup> /670 <sup>2</sup>	560 <sup>1</sup> /670 <sup>2</sup>	670 <sup>1</sup> /870 <sup>2</sup>	680 <sup>1</sup> /885 <sup>2</sup>	830 <sup>1</sup> /1080 <sup>2</sup>	820 <sup>1</sup> /1070 <sup>2</sup>	845 <sup>1</sup> /1095 <sup>2</sup>

<sup>1</sup>) Mesh reinforcement / <sup>2</sup>) Horizontal bar reinforcement

\* ) It is not necessary to use supplementary transverse reinforcement in models SUMO 16H and SUMO 20H if the conditions of paragraph 8.7.4 of EN 1992-1-1 are fulfilled.

Figure 8. Supplementary reinforcement for SUMO Wall Shoes with two anchor bars (SUMO 39H shown in the pictures).

Supplementary reinforcement on one side

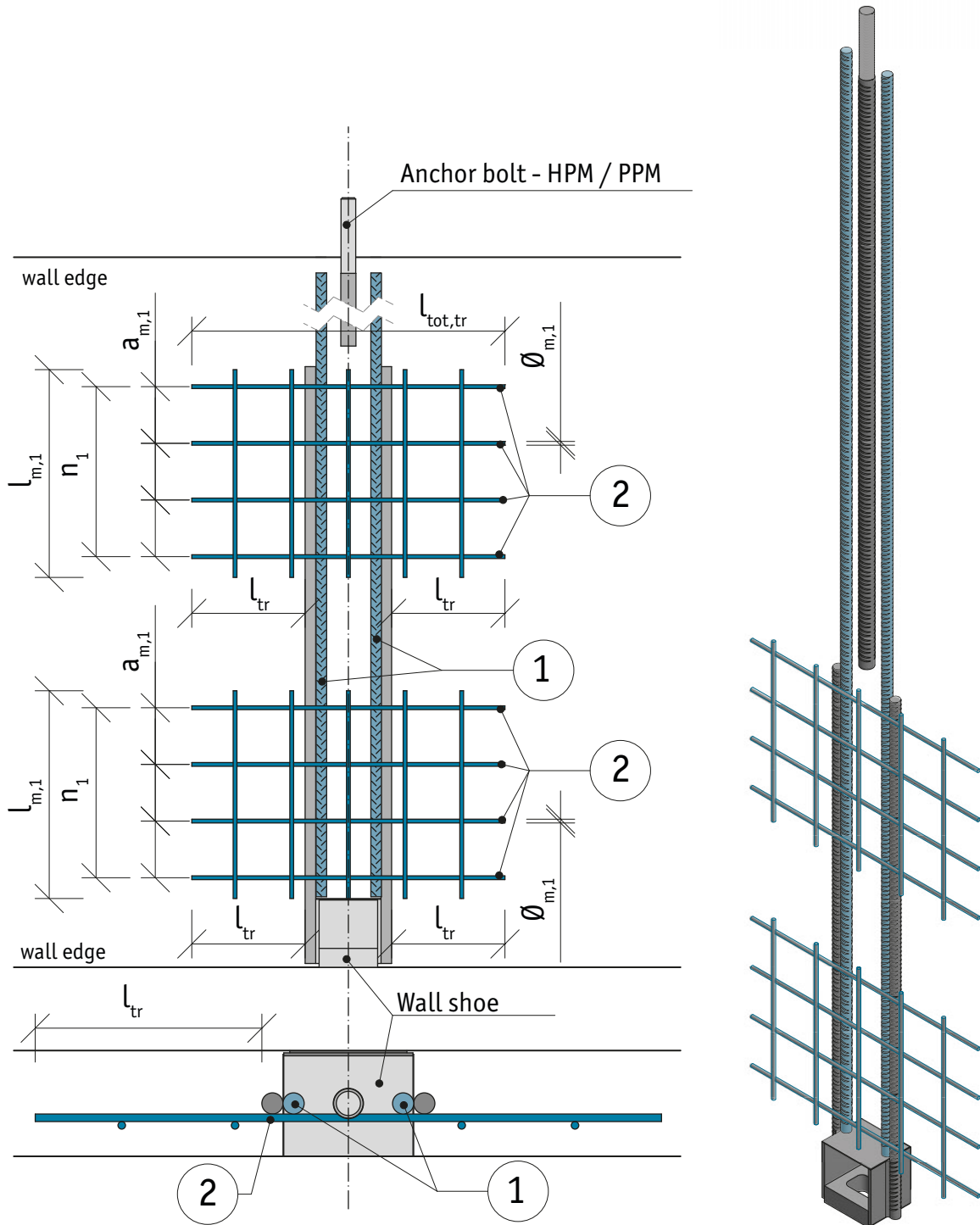

Supplementary reinforcement on both sides

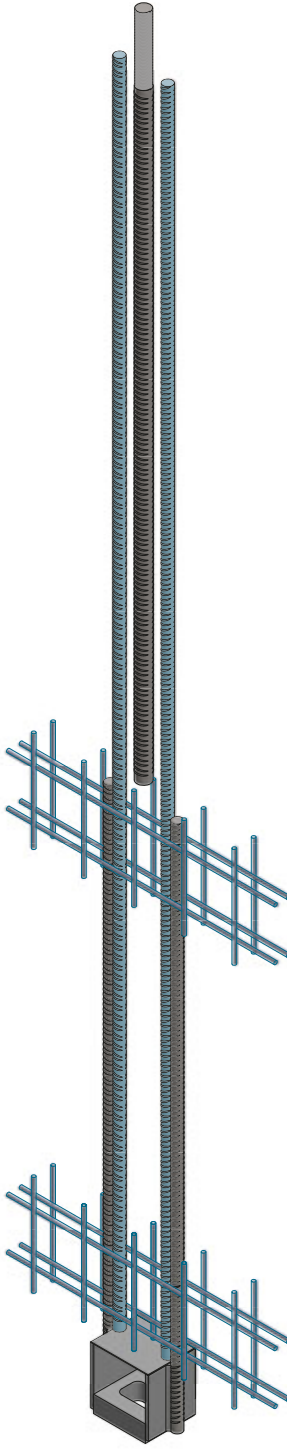
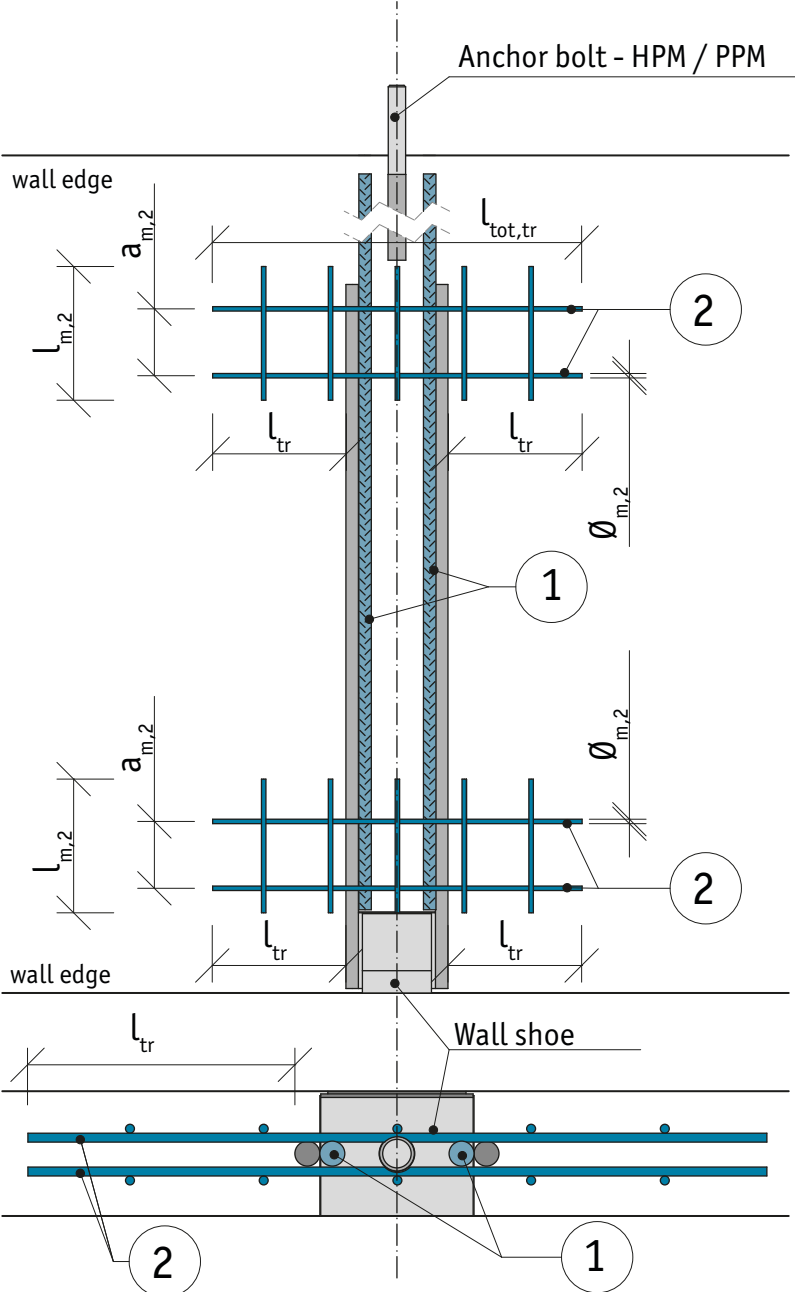

Models with four anchor bars

Table 6. Supplementary reinforcement required (B500B).

		SUMO 39P	SUMO 45P	SUMO 52P
<b>Supplementary continuity reinforcement</b>				
Reinforcement bars ①		4 Ø 28	4 Ø 32	4 Ø 32
<b>Supplementary transverse reinforcement</b>				
Stirrup ③	$\varnothing_s$ [mm]	Ø 8	Ø 8	Ø 8
	$a_s$ [mm]	100	120	130
	$n_s$ [-]	5	5	6

Figure 9. Supplementary reinforcement for SUMO Wall Shoes with four anchor bars (SUMO 39P shown in the pictures).

Supplementary reinforcement with stirrups

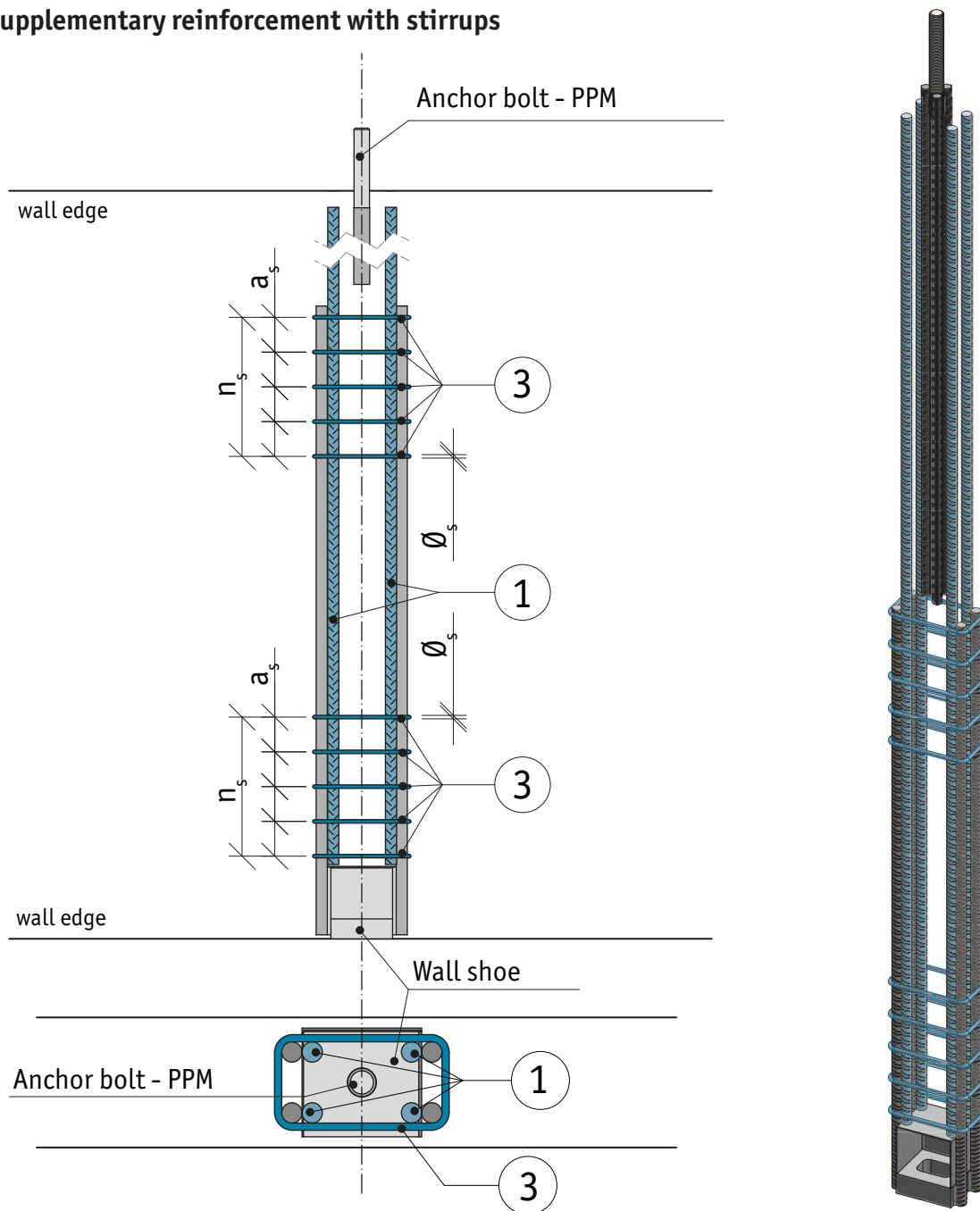

## INSTALL THE PRODUCT – PRECAST FACTORY

### Identification of the product

SUMO Wall Shoes are available in standard models analogous to the M-thread sizes of the HPM and PPM Anchor Bolts. The model of the wall shoe can be identified by the name on the product's label and also according to the color of the product. The color codes are shown in the table below.

*SUMO Wall Shoe with corresponding Peikko Anchor Bolts.*

Wall Shoe	Anchor Bolt	Color Code
SUMO 16H	HPM 16 + AL 16	Yellow
SUMO 20H	HPM 20 + AL 20	Blue
SUMO 24H	HPM 24 + AL 24	Gray
SUMO 30H	HPM 30 + AL 30	Green
SUMO 39H	HPM 39 + AL 39	Orange
SUMO 30P	PPM 30 + AL 30	Black
SUMO 36P	PPM 36 + AL 36	Red
SUMO 39P	PPM 39 + AL 39	Brown
SUMO 45P	PPM 45 + AL 45	Purple
SUMO 52P	PPM 52 + AL 52	White



## Installation of the wall shoes

The SUMO Wall Shoes are placed into the reinforcement of the wall and attached to the mold. This could be done using bolts or clamps. Supplementary reinforcement must be provided in accordance with Appendix A. The maximum installation tolerances of the wall shoe in the precast wall element are given in the below table.

*Installation tolerance of wall shoe and anchor bolt [mm].*

Wall Shoe	SUMO 16H	SUMO 20H	SUMO 24H	SUMO 30H	SUMO 39H	SUMO 30P	SUMO 36P	SUMO 39P	SUMO 45P	SUMO 52P
Longitudinal direction	$T_{w,l}$	±5	±5	±5	±5	±5	±5	±5	±5	±5
Transversal direction	$T_{w,t}$	±2	±2	±3	±3	±3	±3	±3	±4	±4

Anchor Bolt	HPM 16	HPM 20	HPM 24	HPM 30	HPM 39	PPM 30	PPM 36	PPM 39	PPM 45	PPM 52
Protrusion of the bolt	$h_b$	100	110	115	135	145	165	185	195	220
Installation tolerance for the single bolt	$T^*$	±3	±3	±3	±3	±3	±4	±4	±4	±5

\*The installation tolerances for bolts are in accordance with the technical manual for HPM and PPM Anchor Bolts



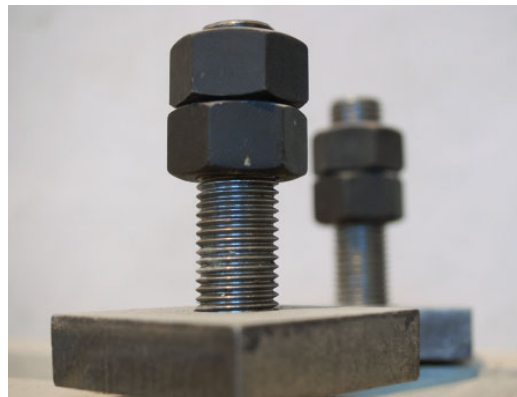
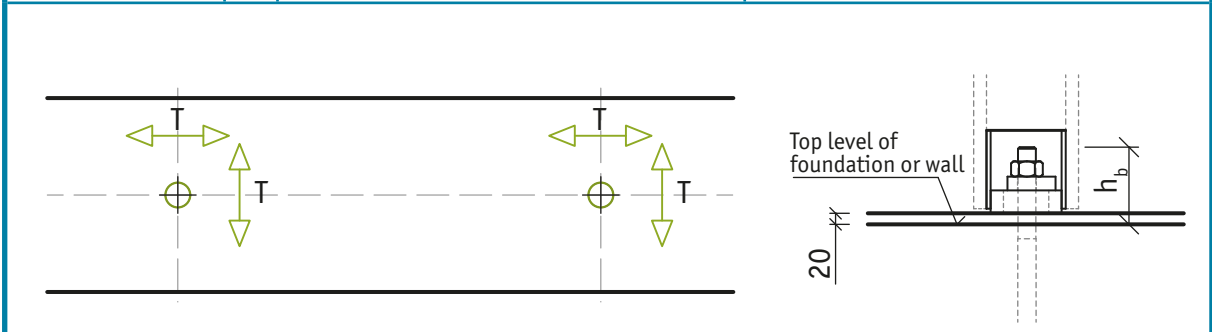
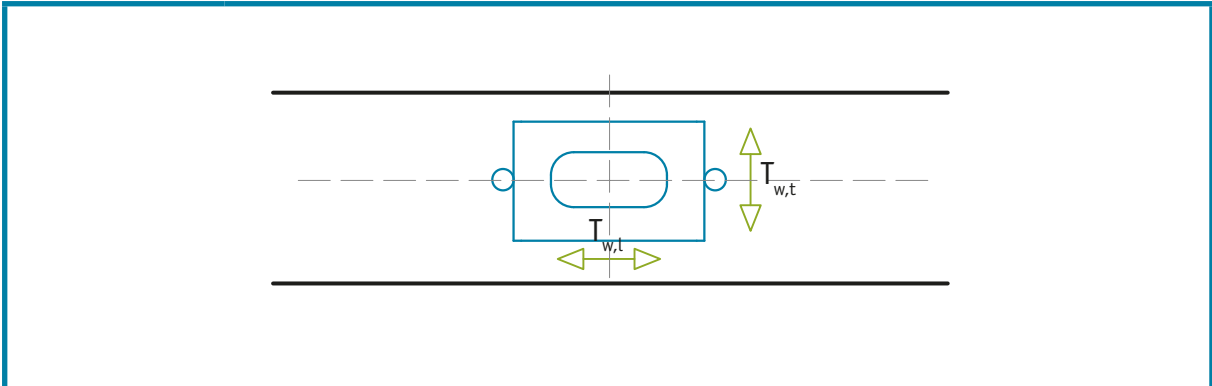











## INSTALL THE PRODUCT – CONSTRUCTION SITE

### Identification of the product

SUMO Wall Shoes are available in standard models analogous to the M-thread sizes of the HPM and PPM Anchor Bolts. The model of the wall shoe can be identified by the name on the product's label and also according to the color of the product. The color codes are shown in the table below.

*SUMO Wall Shoe color identification.*

Wall Shoe	Anchor Bolt	Color Code
SUMO 16H	HPM 16 + AL 16	 Yellow
SUMO 20H	HPM 20 + AL 20	 Blue
SUMO 24H	HPM 24 + AL 24	 Gray
SUMO 30H	HPM 30 + AL 30	 Green
SUMO 39H	HPM 39 + AL 39	 Orange
SUMO 30P	PPM 30 + AL 30	 Black
SUMO 36P	PPM 36 + AL 36	 Red
SUMO 39P	PPM 39 + AL 39	 Brown
SUMO 45P	PPM 45 + AL 45	 Purple
SUMO 52P	PPM 52 + AL 52	 White



### Erection of precast walls

The precast wall element is erected to the correct height with the help of shim plates. The element must be supported with temporary braces. The element must be checked to ensure that it is in the right position before the nuts are tightened using a slog ring spanner (DIN 7444) and a 1.5 kg sledgehammer or equivalent. As the nuts are tightened, the washer must be turned inside the recess area. The lower joint of the element can be grouted afterwards or the element can be erected on fresh non-shrinking mortar. Before the upper structures are erected, the joint underneath the wall and bolt recesses should be grouted by following the instructions of the grout material provider. The grout must be of a non-shrinking type. After the grouting has reached sufficient strength, the connection is finalized.



## Erection of a precast concrete wall step by step.

The wall is installed on pre-leveled shim plates

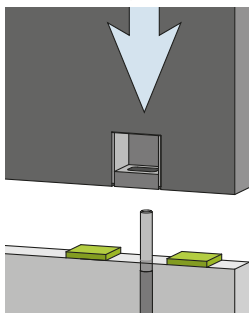

The nuts and washers are screwed on and tightened.

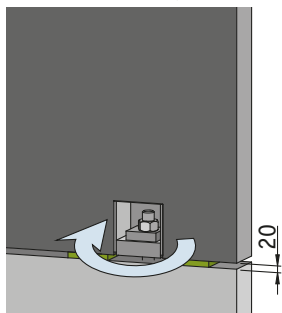

The connection is ready for grouting

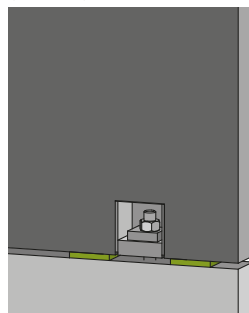

The finalized connection after the grouting has hardened

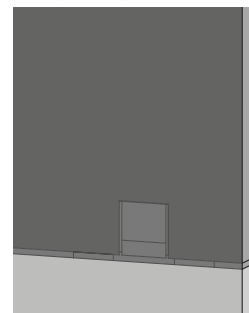

Installation tolerance of precast wall and anchor bolt [mm].

Wall Shoe		SUMO 16H	SUMO 20H	SUMO 24H	SUMO 30H	SUMO 39H	SUMO 30P	SUMO 36P	SUMO 39P	SUMO 45P	SUMO 52P
Tolerances of precast wall in longitudinal direction	$T_{c,l}$ [mm]	±20	±20	±20	±20	±20	±20	±20	±20	±20	±20
Tolerances of precast wall in transversal direction	$T_{c,t}$ [mm]	±5	±5	±5	±5	±5	±5	±5	±5	±6	±6

Anchor Bolt		HPM 16	HPM 20	HPM 24	HPM 30	HPM 39	PPM 30	PPM 36	PPM 39	PPM 45	PPM 52
Protrusion of the bolt	$h_b$	100	110	115	135	160	145	165	185	195	220
Installation tolerance for the single bolt	$T^*$	±3	±3	±3	±3	±3	±3	±4	±4	±4	±5

\*The installation tolerances for bolts are in accordance with the technical manual for HPM and PPM Anchor Bolts

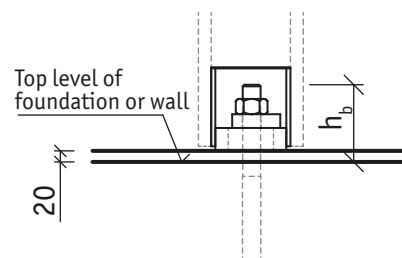
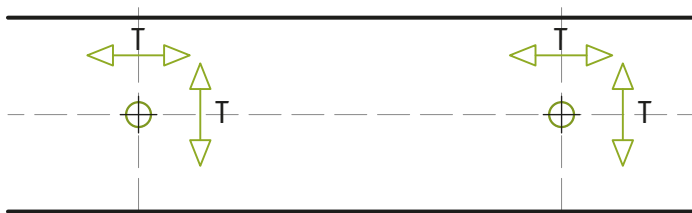
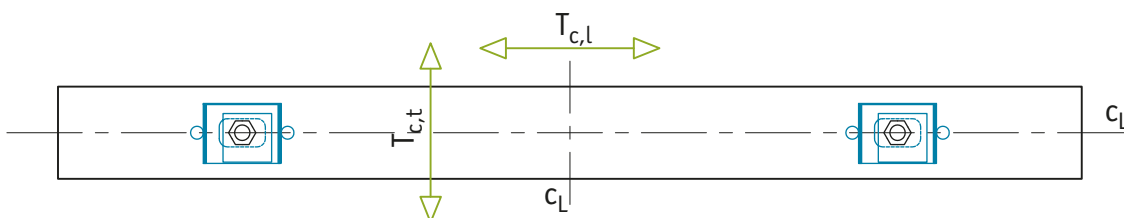

## Technical Manual Revisions

**Version: PEIKKO GROUP 11/2014. Revision:004\***

- New cover design for 2018 added.

# Resources

## **DESIGN TOOLS**

Use our powerful software every day to make your work faster, easier, and more reliable. Peikko design tools include design software, 3D components for modeling programs, installation instructions, technical manuals, and product approvals of Peikko's products.

[peikko.com/design-tools](https://peikko.com/design-tools)

## **TECHNICAL SUPPORT**

Our technical support teams around the world are available to assist you with all of your questions regarding design, installation etc.

[peikko.com/technical-support](https://peikko.com/technical-support)

## **APPROVALS**

Approvals, certificates, and documents related to CE-marking (DoP, DoC) can be found on our websites under each products' product page.

[peikko.com/products](https://peikko.com/products)

## **EPDS AND MANAGEMENT SYSTEM CERTIFICATES**

Environmental Product Declarations and management system certificates can be found at the quality section of our websites.

[peikko.com/qehs](https://peikko.com/qehs)

COMPANY WITH  
MANAGEMENT SYSTEM  
CERTIFIED BY DNV  
ISO 9001 • ISO 14001  
ISO 45001